

Safety in system:
Protection for man and machine

CATALOGUE SAFETY TECHNOLOGY

Version 6



SCHMERSAL
THE DNA OF SAFETY

INTRODUCTION



Heinz and Philip Schmersal,
Managing Directors of the Schmersal Group

New solutions to improve production efficiency and machine safety

Safety in system – Protection for man and machine

Often, it is unavoidable that people have to intervene with the workings of a machine. When this is done, the safety of the operator is imperative. This demands the responsibility of the machine operator, which is also required by the world's standards and guidelines for machine safety.

The Schmersal Group has concentrated for many years on safety at work with our products and solutions; today we can offer the industry the world's largest range of safety switchgear and systems for the protection of man and machine.

Under the guiding principle "Safety with system – protection for man and machine" we develop and produce products that carry the system concept and can be optimally integrated into the work processes. Because we are convinced that safety does not contradict higher productivity.

In our fields of activity we have a leading position due to our expertise, our innovative power and our comprehensive range of products. With this we follow a central theme: Together with you, we want to make the world a little safer. Talk to us – we look forward to working with you.

CONTENT

■ Content and Introduction	Page	1
■ Safety guard monitoring	Page	10
1. Safety switches with separate actuator	Page	10
2. Solenoid interlocks	Page	30
3. Key trapped systems	Page	64
4. Position switches	Page	84
5. Safety switches for hinged guards	Page	106
6. Safety sensors	Page	116
■ Command devices with safety function	Page	138
7. Pull-wire emergency stop switches	Page	138
8. EMERGENCY STOP control devices	Page	144
9. Control panels	Page	158
10. Enabling switches	Page	168
11. Safety foot switches	Page	172
12. Two-hand control panels	Page	176
■ Tactile safety devices	Page	184
13. Safety edges	Page	184
14. Safety mats	Page	192
■ Optoelectronic safety devices	Page	196
15. Safety light barriers	Page	202
16. Safety light grids and curtains	Page	204
■ Safe signal processing	Page	220
17. Safety-monitoring modules	Page	220
18. Multifunctional compact safety modules	Page	246
19. Programmable modular safety controller	Page	252
■ System solutions	Page	258
20. AS-Interface Safety at Work	Page	258
21. SD Interface	Page	270
22. Passive distribution modules and fieldboxes	Page	272
23. Safety field boxes SFB	Page	276
■ tec.nicum – Developed services relating to machine safety and industrial safety	Page	280
■ Appendix	Page	282
Connecting wires or interconnectors	Page	282
Product index – alphabetical	Page	290
Addresses	Page	292

CHAPTER OVERVIEW

Guard door monitoring



1. Safety switches with separate actuator
Page 10



2. Solenoid interlocks
Page 30

Control devices with safety function



7. Pull-wire emergency stop switches
Page 138



8. Emergency stop control devices
Page 144

Tactile safety devices

Optoelectronic safety devices

Safe signal processing

System solutions



3. Key trapped systems
Page 64



4. Position switches
Page 84



5. Safety switches for hinged guards
Page 106



6. Safety sensors
Page 116



9. Control panels
Page 158



10. Enabling switches
Page 168



11. Safety foot switches
Page 172



12. Two-hand control panels
Page 176



13. Safety edges
Page 184

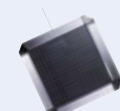

14. Safety mats
Page 192



15. Safety light barriers
Page 202



16. Safety light grids and curtains
Page 204



17. Safety-monitoring modules
Page 220



18. Multifunctional safety controller
Page 246



19. Programmable modular safety controller
Page 252



20. AS-Interface Safety at Work
Page 258



21. SD Interface
Page 270



22. Passive distribution modules and fieldboxes
Page 272



23. Safety field boxes SFB
Page 276

SAFETY IN SYSTEM: PROTECTION FOR MAN AND MACHINE



Safety switch
with separate actuator



Solenoid interlocks



Safety sensors

This catalogue divides the entire program into 23 categories and technologies. At the beginning of each chapter there is a summary of the area of application, the design and way of operation of around 25,000 different safety switchgear devices. Then follows the main technical specifications of the individual range of products.

Invitation to information

Even if the catalogue is quite extensive with its 300 pages: It contains only the most important data of the safety switchgear and should offer the reader an overview of the overall programme and is the first step to help in making a selection. For every product group, every technology and every series there is detailed information both in print and from the online catalogue at products.schmersal.com. In addition, the worldwide network of Schmersal sales engineers as well as trading partners are available for further questions.

Diversity as a principle

The catalogue shows the versatility of the Schmersal program when it comes to machine safety. The diversity is a principle according to which the Schmersal Group organises and structures its cooperation with customers in the industry. For every conceivable situation for safeguarding against hazards and hazardous areas the user should be offered the optimal Technical Safety solution.

From product to system

Based on the wide range of products – this is another principle of the market strategy of Schmersal – system solutions can be configured for example, from one or more different safety switchgear devices and the related evaluation of the safety-related signals. Here, the Schmersal programme offers not only safety relay modules but also different types of safety controllers as well as components for the system solution AS-Interface Safety at Work.

In addition, there are installation systems and installation aids for simple system integration of Schmersal safety switchgear for fast and thereby cost-effective wiring of safety switchgear in series. The solutions come either as passive distribution modules or field boxes or as versions for parallel IO wiring or wiring with the SCHMERSAL SD Interface. All versions are designed for mixed series connection of different types of electronic safety switchgear, such as sensors and interlocks.



Optoelectronic safety devices



Safe signal processing



Command devices with safety function

The right solutions for every industry

In addition, the Schmersal group has developed product lines for end-to-end solutions for defined target industries – such as for the packaging industry, the food industry, heavy industry, and Lift Technology. In these industries there are for example the specific requirements that apply to hygiene (food technology), on the durability of the switchgear in extreme conditions (heavy industry) or in the normative legislation (Lift Technology).

“Safety Services” – qualified services

In recent years, the Schmersal Group has taken a comprehensive portfolio of professional services into the program and has a systematic approach – the cooperation with specialised engineering offices (in the CE-network), the construction of a large convention centre (the tec.nicum in Wuppertal), the qualification of certified “Functional Safety Engineers” in about 20 nations, and the creation of a new service department at the individual sites and markets.

Whatever service the machine manufacturer or the owner use: They benefit from the extensive know-how of the Schmersal group, not only when it comes to the content and understanding, but above all with the practical implementation of the contents of the individual standards for machine safety. This applies both to the customer specific programming of safety controllers (Application Engineering) as well as for the support for the CE conformity assessment procedures and the consultancy available for the safety optimisation of existing equipment (Application Consulting).

Comprehensive quality insurance to 2006/42/EC

Schmersal is a certified company to appendix X of the Machinery Directive. As a result, Schmersal is entitled to autonomously conduct the conformity assessment procedure for the products listed in Appendix IV of the MD without involving a notified body. The prototype test certificates are available upon request or can be downloaded from the Internet at products.schmersal.com.

For good collaboration!

If after you have reviewed the catalogue you require more information on the individual product lines or you have specific questions, please contact the worldwide Schmersal network. It is quick and you have the possibility to receive more and varied in-depth information. We look forward to working closely with you.

HISTORY

MILESTONES 1945 – 2021



Schmersal Brazil 1974



Schmersal China 2013



Startup of the new central warehouse in 2013

1945

The brothers Kurt Andreas Schmersal and Ernst Schmersal **form** the company in Wuppertal.

1950s

The **product portfolio** is continuously expanded. Many switchgears are used in safety related applications such as in explosive areas.

1970s

Schmersal is one of the first companies to begin development and production of **electronic proximity switches**.

1974

ACE Schmersal is formed in Boituva, Brazil.

1982

Generational change: Heinz and Stefan Schmersal take over the company from their fathers.

1997

ELAN Schaltelemente GmbH & Co. KG based in Wettenberg is acquired.

1999

The production facility **Schmersal Industrial Switchgear Co. Ltd (SISS)** is formed in Shanghai, China.

2007

Philip Schmersal joins the **third generation of the** Schmersal Group.

2008

Schmersal takes over **Safety Control GmbH** based in Mühldorf/Inn.

2013

Böhnke + Partner Steuerungssysteme GmbH is acquired.
Schmersal India becomes a production facility.
Startup of the new **European central warehouse** in Wuppertal.

2016

The Schmersal Group is establishing its own business area for services under the name **tec.nicum**.

2017

Schmersal founds an independent **subsidiary** in Japan.

2019

Schmersal establishes **new branches** in Bangkok (Thailand) and Dubai (UAE).

2020

In 2020, the Schmersal Group celebrated its **75th anniversary**.

SCHMERSAL WORLDWIDE



- Germany, Wuppertal
- Germany, Wetztenberg
- Germany, Mühlendorf
- Germany, Bergisch Gladbach
- Brazil, Boituva
- China, Shanghai
- India, Pune

- Austria, Vienna
- Belgium, Aarschot
- Canada, Orangeville
- Denmark, Ballerup
- Finland, Helsinki
- France, Seyssins
- Italy, Borgosatollo
- Japan, Yokohama
- Netherlands, Harderwijk
- Norway, Oslo
- Portugal, Póvoa de Sta. Iria
- Spain, Barcelona
- Sweden, Mönlycke
- Switzerland, Arni
- United Kingdom, Malvern, Worcestershire
- USA, Hawthorne NY

- Argentina, Buenos Aires
- Australia, Brisbane
- Baltic States, Kaunas
- Belarus, Minsk
- Bolivia, Santa Cruz de la Sierra
- Bulgaria, Ruse City
- Chile, Santiago
- Colombia, Medellín
- Croatia, Zagreb
- Czech Republic, Prague
- Ecuador, Quito
- Greece, Athens
- Guatemala, Guatemala City
- Hungary, Győr
- Iceland, Reykjavik
- Indonesia, Jakarta
- Israel, Petach Tikva
- Kazakhstan, Ayrán
- Macedonia, Skopje
- Malaysia, Rawang
- Mexico, Mexico City

- New Zealand, Christchurch
- Pakistan, Islamabad
- Paraguay, Minga Guazú
- Peru, Lima
- Poland, Warsaw
- Romania, Sibiu
- Serbia, Belgrade
- Singapore, Singapore
- Slovenia, Ljubljana
- South Africa, Johannesburg
- South Korea, Seoul
- Taiwan, Taichung
- Thailand, Bangkok
- Turkey, Istanbul
- Ukraine, Kiev
- United Arab Emirates, Sharjah
- Uruguay, Montevideo
- Venezuela, Caracas
- Vietnam, Hanoi

With its own affiliates in around 20 countries and capable sales and service partners in 45 more countries, the Schmersal Group has operations worldwide.

We started quite early with the internationalisation of sales, consultancy and production. This is also one of the reasons that we are a favoured global partner for machinery and plant construction and also an approved partner for many medium sized engineering companies with local presence. Wherever there are machines that work with Schmersal safety switches, the nearest branch or representative is not far away.

SCHMERSAL WORLDWIDE OFFICES IN GERMANY



WUPPERTAL

K.A. Schmersal GmbH & Co. KG

- Founded in 1945
- Around 760 employees

Focal points

- Headquarters of the Schmersal Group
- Development and manufacture of switchgears and switching systems for safety, automation and lift engineering
- Accredited test laboratory
- Central research and development
- Logistics centre for European markets



WETTENBERG

K.A. Schmersal GmbH & Co. KG

- Founded in 1952 (1997)
- Around 130 employees

Focal points

- Development and manufacture of switchgears for operation and monitoring, safety-related relay modules and controls as well as switchgears for explosion protection



MÜHLDORF / INN

Safety Control GmbH

- Founded in 1994 (2008)
- Around 30 employees

Focal points

- Development and manufacture of optical electronic components for safety and automation engineering



BERGISCH GLADBACH

Böhnke + Partner GmbH Steuerungssysteme

- Founded in 1991 (2013)
- Around 90 employees

Focal points

- Development and manufacture of components, controls and remote diagnostic systems for the lift industry

() = inclusion in the Schmersal Group

SCHMERSAL WORLDWIDE INTERNATIONAL OFFICES

BOITUVA / BRAZIL

ACE Schmersal

- Founded in 1974
- Around 400 employees

Focal points

- Manufacture of electromechanical and electronic switchgears
- Customer-specific control systems for the North and South American market



SHANGHAI / CHINA

Schmersal Industrial Switchgear Co. Ltd

- Founded in 1999
- Around 150 employees

Focal points

- Development and manufacture of switchgears for safety, automation and lift engineering



PUNE / INDIA

Schmersal India Private Limited

- Founded in 2013
- Around 60 employees

Focal points

- Development and manufacture of switchgears for safety, automation and lift engineering



1. SAFETY SWITCHES WITH SEPARATE ACTUATOR

DESCRIPTION

AREA OF APPLICATION

Safety switches with separate actuators are widely used in the entire production. For example, they are used in almost all types of machine tools. A major reason for this is that these types of safety switches offer certain benefits when frequent access to the danger point is required for the purpose of operating machinery, repairing faults, or setting-up.

They are suitable for monitoring the position of hinged, sliding and especially for removable safety guards, which need to be closed to ensure the necessary operational safety. They are also suitable for fitting onto profile sections and existing equipment.

DESIGN AND WAY OF FUNCTIONING

In contrast to position switches (type 1 switch), the safety switches with class 2 – according to EN ISO 14119 – do not have the switching element and actuator physically connected. When switching they are functionally brought together or separated. If the operator opens the safety door, the actuator is separated from the base unit. This causes the safety switch NC contacts to be opened and the NO contacts closed.

The Schmersal Group offers in this core area of its product range, an extraordinarily wide range of different product ranges. They differ, for example by their design and size, the materials used, the integration of additional functions as well as by the number of safety contacts and the connection type.

Safety switches are designed so that when they are installed their function cannot be easily changed or bypassed with simple aids (which includes, by definition, normal every day tools, nails, straight or simply curved wire pieces). If even higher demands on manipulation protection is required, there are product ranges available with individual coding. For these product ranges, there are different types of actuators that are matched by the key-lock principle. Therefore you can almost exclude the fact that the operator is able to obtain a replacement actuator.



All class 2 safety switches shown in this section correspond to at least IP67 degree of protection and can be used in conjunction with an appropriate safety relay module that reach the performance level d and e according to EN ISO 13849-1. Information for the selection of suitable safety relay modules can be found in the chapter "Safety relay modules" (refer to page 220).

The electromechanical safety switches AZ 16 and AZ 17 are also available as individually coded versions with more than 1,000 different coding variants, achieving coding level "high" in accordance with EN ISO 14119.

To do this, the switch is supplied with the corresponding actuator, which is specially adapted to the respective switch. Manipulation by a substitute actuator is not possible.

The Schmersal Group safety switch range includes versions with integrated AS-i SaW interface (AS-Interface Safety at Work). They take advantage of the simple and proven bus system based on the open standards AS-International and can be integrated over the appropriate system modules in parent communication networks ("Safety Integrated" / "Separated Safety").

Also available are ATEX certified versions. They allow the use in potentially explosive environments.

1. SAFETY SWITCHES WITH SEPARATE ACTUATOR

OVERVIEW OF THE SERIES



■ AZ 15



■ AZ 16



■ AZ 17

Key Features

<ul style="list-style-type: none"> ▪ Thermoplastic enclosure ▪ 1 contact ▪ 4 actuator slots ▪ 3 cable entries ▪ Screw terminals or connector 	<ul style="list-style-type: none"> ▪ Thermoplastic enclosure ▪ Up to 3 contacts ▪ Individual coding possible ▪ 4 actuator slots ▪ 3 cable entries ▪ Screw terminals or connector 	<ul style="list-style-type: none"> ▪ Thermoplastic enclosure ▪ 2 contacts ▪ Individual coding possible ▪ Small body ▪ incl. cable gland ▪ Screw terminals or connector
---	--	--

Other versions

ATEX / IECEx	-	■	-
AS-i SaW (see page 258)	-	■	-
SD Interface (see page 270)	-	-	-

Technical features

Electrical characteristics			
Operating voltage	-	-	-
Operating current	-	-	-
Max. switching capacity U/I	230 VAC / 4 A	230 VAC / 4 A	230 VAC / 4 A
Mechanical data			
Dimensions (W x H x D)	52 x 75 x 30 mm	52 x 90 x 30 mm	30 x 85 x 30 mm
Ambient conditions			
Ambient temperature	-30 °C ... +80 °C	-30 °C ... +80 °C	-30 °C ... +80 °C
Degree of protection	IP67	IP67	IP67
Actuator and accessories refer to ...	Page 16	Page 16	Page 19

Safety classification

Standards	EN ISO 13849-1	EN ISO 13849-1	EN ISO 13849-1
B₁₀₀ NC contact	2,000,000	2,000,000	2,000,000
PL/ SIL	-/-	-/-	-/-
Control category	-	-	-
PFH	-	-	-
Certificates	TÜV, cULus, CCC, EAC	TÜV, cULus, CCC, EAC	BG, cULus, CCC, EAC



To get detailed information about the products and certificates, visit products.schmersal.com.



■ AZ 3350



■ AZ 415



■ AZ 201

- Metal enclosure
- Up to 3 contacts
- Actuator heads can be repositioned in steps 4 x 90°
- Robust design
- 1 cable entry
- Screw terminals

- Metal enclosure
- Up to 6 contacts
- Robust design
- Screw terminals

- Thermoplastic enclosure
- Individual coding possible
- 2 safe semiconductor outputs
- Large horizontal and vertical misalignment
- Optimised for mounting on 40 mm profiles
- Screw terminal or cage clamp or connector

■	■	-
-	-	■
-	-	■

-	-	24 VDC
-	-	0.2 A (without load)
230 VAC / 4 A	230 VAC / 4 A	24 VDC / 0.25 A
40.5 x 114 x 38 mm	84.6 x 103.6 x 46.5 mm	40 x 220 x 50 mm
-30 °C ... +90 °C	-25 °C ... +70 °C	-25 °C ... +70 °C
IP67	IP67	IP66, IP67
Page 22	Page 24	Page 26

EN ISO 13849-1	EN ISO 13849-1	EN ISO 13849-1, IEC 61508
2,000,000	2,000,000	-
-/-	-/-	e/3
-	-	4
-	-	1.9 x 10 ⁻⁹ / h
TÜV, cULus, EAC	BG, cULus, CCC, EAC	TÜV, cULus, EAC

1. SAFETY SWITCHES WITH SEPARATE ACTUATOR

PREFERRED TYPES

Range	Coding	Termination	Contacts or outputs	Latching force	Included in delivery	Type	Material number			
AZ 15 	Standard coding	Screw terminals	1 NC	---	---	AZ 15ZVK-M16	101152787			
				5 N		AZ 15ZVK-M20	101157375			
				30 N		AZ 15ZVRK-M16-2254	101151298			
						AZ 15ZVRK-M20-2254	101164455			
						AZ 15ZVRK-M16	101153619			
						AZ 15ZVRK-M20	101157376			
AZ 16 	Standard coding	Screw terminals	1 NO / 1 NC	---	---	AZ 16ZVK-M16	101152887			
				5 N		AZ 16ZVRK-M16-2254	101167057			
				30 N		AZ 16ZVRK-M20-2254	101161097			
			2 NC	---	---	AZ 16ZVRK-M16	101152094			
				5 N		AZ 16ZVRK-M20	101157379			
				30 N		AZ 16-02ZVK-M16	101154699			
						AZ 16-02ZVK-M20	101157377			
			3 NC	---	---	AZ 16-02ZVRK-M16-2254	101156104			
				5 N		AZ 16-02ZVRK-M20-2254	101161096			
				30 N		AZ 16-02ZVRK-M16	101147145			
						AZ 16-02ZVRK-M20	101157381			
			1 NO / 2 NC	---	---	AZ 16-03ZVK-M16	101155113			
				5 N		AZ 16-03ZVK-M20	101157372			
				30 N		AZ 16-03ZVRK-M16-2254	101164458			
						AZ 16-03ZVRK-M20-2254	101164459			
			1 NO / 2 NC	---	---	AZ 16-03ZVRK-M16	101154220			
				5 N		AZ 16-03ZVRK-M20	101157374			
				30 N		AZ 16-12ZVK-M16	101152725			
						AZ 16-12ZVK-M20	101157371			
			1 NO / 2 NC	---	---	AZ 16-12ZVRK-M16-2254	101153566			
				5 N		AZ 16-12ZVRK-M20-2254	101164456			
				30 N		AZ 16-12ZVRK-M16	101154221			
						AZ 16-12ZVRK-M20	101157373			
					Connector	1 NO / 1 NC	30 N	---	AZ 16ZVRK-ST	101143124
			Individual coding	Screw terminals		3 NC	---		AZ 16-03ZIB1-M16	101150055
									AZ 16-03ZIB1-M20	101150637
						1 NO / 2 NC			AZ 16-12ZIB1-M16	101150050
	AZ 16-12ZIB1-M20	101150623								
		Actuator B6L				AZ 16-12ZIB6L-M16			103005854	
		Actuator B6R				AZ 16-12ZIB6R-M16			103005855	

A variety of other types of safety switches with separate actuators can be found at products.schmersal.com.

1. SAFETY SWITCHES WITH SEPARATE ACTUATOR



PREFERRED TYPES

Range	Coding	Termination	Contacts or outputs	Latching force	Included in delivery	Type	Material number
AZ 17 	Standard coding	Cut clamps	1 NO / 1 NC	5 N	---	AZ 17-11ZK	101121960
			2 NC			AZ 17-02ZK	101121961
		Connector	1 NO / 1 NC	30 N		AZ 17-02ZRK	101133968
				5 N		AZ 17-11ZRK-ST	101140774
			2 NC	30 N		AZ 17-02ZK-ST	101140773
				5 N		AZ 17-02ZRK-ST	101140775
	Individual coding	Cut clamps	1 NO / 1 NC	5 N	Actuator B1	AZ 17-11ZIB1	101121962
					Actuator B5	AZ 17-11ZIB5	101122853
					Actuator B6L	AZ 17-11ZIB6L	101122857
				30 N	Actuator B6R	AZ 17-11ZIB6R	101122855
					Actuator B5	AZ 17-11ZRIB5	101136305
					Actuator B6L	AZ 17-11ZRIB6L	101136307
		2 NC	5 N	Actuator B6R	AZ 17-11ZRIB6R	101136306	
				Actuator B5	AZ 17-02ZIB5	101122854	
				Actuator B6L	AZ 17-02ZIB6L	101122858	
			30 N	Actuator B6R	AZ 17-02ZIB6R	101122856	
				Actuator B1	AZ 17-02ZRIB1	101136308	
				Actuator B5	AZ 17-02ZRIB5	101136309	
Actuator B6L	AZ 17-02ZRIB6L	101136311					
	Actuator B6R	AZ 17-02ZRIB6R	101136310				
AZ 3350 	Standard coding	Screw terminals	1 NO / 2 NC	---	---	AZ 3350-12ZUEK	101214053
			3 NC			AZ 3350-03ZK	101214052
AZ 415 	Standard coding	Screw terminals	4 NC	80 ... 400 N	---	AZ 415-02/02ZPK-M20	101164609
			2 NO / 2 NC			AZ 415-11/11ZPK-M20	101154000
			3 NO / 3 NC			AZ 415-33ZPK-M20	101164612
AZ 201 	Standard coding	Cage clamps	Diagnostic output and 2 safety outputs, all p-type	30 N	---	AZ201CC-T-1P2P	103015814
		Screw terminals				AZ201SK-T-1P2P	103015815
		Connector				AZ201ST2-T-1P2P	103015816
	Individual coding	Cage clamps				AZ201-I2-CC-T-1P2P	103015817
		Screw terminals				AZ201-I2-SK-T-1P2P	103015818
		Connector				AZ201-I2-ST2-T-1P2P	103015819

1. SAFETY SWITCHES WITH SEPARATE ACTUATOR

AZ 15/16 – SELECTION OF THE ACTUATORS

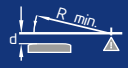

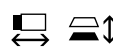

Actuator type	Actuator description	Designed for					Type designation	Material number
			R_{min} [mm]	d [mm]	R_{min} [mm]	d [mm]		
Flexible actuator	Included in standard version		---	---	45	11	AZ 15/16-B2	101095558
	With magnetic latch		---	---	45	11	AZ 15/16-B2-1747	101096089
	Included in standard version		32	11	---	---	AZ 15/16-B3	101095550
	With magnetic latch		32	11	---	---	AZ 15/16-B3-1747	101096090
	Included in standard version		25	11	38	11	AZ 15/16-B6	101137434
Straight actuator	Included in standard version		---	---	---	---	AZ 15/16-B1	101083036
	With magnetic latch		---	---	---	---	AZ 15/16-B1-1747	101093553
	With slot lip-seal		---	---	---	---	AZ 15/16-B1-2024	101108278
	With ball latch		---	---	---	---	AZ 15/16-B1-2053	101111081
	With centering guide		---	---	---	---	AZ 15/16-B1-2177	101126794
	With rubber mountings		---	---	---	---	AZ 15/16-B1-2245	101137408

Actuating radii

The axis of the hinge must be d [mm] above and in a parallel plane to the top surface of the safety switch. The basis setting provides a minimum radius of R_{min} [mm].

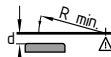
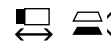
Key

- 
Actuating radius over the small edge of the actuator
- 
Actuating radius over the wide edge of the actuator
- 
Sliding and removable safety guards
- 
Hinged safety guards

Actuators must be ordered separately.

1. SAFETY SWITCHES WITH SEPARATE ACTUATOR

AZ 15/16 – ACTUATORS AND ACCESSORIES



AZ 15/16-B1 *	101083036	AZ 15/16-B1-1747 *	101093553	AZ 15/16-B1-2024 *	101108278
 <ul style="list-style-type: none"> ■ Straight actuator ■ Also with individual coding * 	 <ul style="list-style-type: none"> ■ Straight actuator with magnetic latch ■ Also with individual coding * ■ Holding force approx. 30 N 	 <ul style="list-style-type: none"> ■ Straight actuator with slot lip-seal ■ Also with individual coding * ■ For protection against the ingress of dirt 			
 <ul style="list-style-type: none"> ■ Straight actuator with ball latch ■ Also with individual coding * ■ Holding force approx. 100 N 	 <ul style="list-style-type: none"> ■ Straight actuator with centering guide ■ Also with individual coding * ■ For light non precisely guided doors (flexing etc.) 	 <ul style="list-style-type: none"> ■ Actuator with rubber mounting 			
 <ul style="list-style-type: none"> ■ Flexible actuator ■ For small actuating radius over the wide edge of the actuator (adjustable) 	 <ul style="list-style-type: none"> ■ Flexible actuator with magnetic latch ■ Holding force approx. 30 N 	 <ul style="list-style-type: none"> ■ Flexible actuator ■ For small actuating radius over the small edge of the actuator (adjustable) 			

* The actuators with individual coding cannot be delivered individually.

1. SAFETY SWITCHES WITH SEPARATE ACTUATOR

AZ 15/16 – ACTUATORS AND ACCESSORIES





<p>AZ 15/16-B3-1747 101096090</p>  <ul style="list-style-type: none"> ■ Flexible actuator with magnetic latch ■ Holding force approx. 30 N 	<p>AZ 15/16-B6 101137434</p>  <ul style="list-style-type: none"> ■ Flexible actuator ■ For small actuating radius over the wide or small edge of the actuator (adjustable) 	<p>SZ 16/335 101110500</p>  <ul style="list-style-type: none"> ■ To prevent inadvertent closing, e.g. during maintenance ■ Attachment of up to 6 padlocks ■ Fixing the locking tong with a chain near to the safety switch
<p>MS AZ 16 ...</p>  <ul style="list-style-type: none"> ■ Mounting set only in combination with AZ 15/16-B6 ■ Mounting parallel to safety guard: MS AZ 16 P 101150373 ■ Mounting right-angled to safety guard: MS AZ 16 R/P 101149214 	<p>Ball latch 2053-2 101115025</p>  <ul style="list-style-type: none"> ■ Additional ball latch for stable latching of light to medium-weight guards ■ For separate mounting on the safety guard 	<p>Slot sealing plug AZ 15/16-1476 101089116</p>  <ul style="list-style-type: none"> ■ To cover unused actuator slots ■ For protection against the ingress of dirt ■ Easy to install by just clipping in
<p>Centering device</p>  <ul style="list-style-type: none"> ■ Centering device for pre-positioning (door guidance) ■ Mounting outside: TFA-020 101172607 ■ Mounting inside: TFI-020 101172609 	<p>Tamperproof screws</p>  <ul style="list-style-type: none"> ■ Tamperproof screws with unidirectional slots M5 x 12 101135338 M5 x 16 101135339 M5 x 20 101135340 ■ Quantity 2 pcs 	

Connecting and interconnecting cables are listed in the appendix.
Detailed information regarding the actuator selection and other actuators can be found at products.schmersal.com.

1. SAFETY SWITCHES WITH SEPARATE ACTUATOR

AZ 17 – SELECTION OF THE ACTUATORS

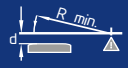

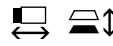
Actuator type	Actuator description	Designed for					Type designation	Material number
			R_{min} [mm]	d [mm]	R_{min} [mm]	d [mm]		
Flexible actuator	AZ 17 standard		50	11	50	11	AZ 17-B6	101126060
	For left-hand side door hinge with individual coding		50	11	50	11	AZ 17i-B6L	Included in delivery
	For right-hand side door hinge with individual coding		50	11	50	11	AZ 17i-B6R	Included in delivery
Straight actuator	Included in standard version		---	---	---	---	AZ 17/170-B1	101122893
	With rubber mountings		---	---	---	---	AZ 17/170-B1-2245	101137406
	Angled		---	---	---	---	AZ 17/170-B5	101122895
	Longer		---	---	---	---	AZ 17/170-B11	101139788
	Longer and angled		---	---	---	---	AZ 17/170-B15	101139789

Actuating radii

The axis of the hinge must be d [mm] above and in a parallel plane to the top surface of the safety switch. The basis setting provides a minimum radius of R_{min} [mm].

Key



Actuating radius over the small edge of the actuator

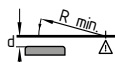

Actuating radius over the wide edge of the actuator



Sliding and removable safety guards



Hinged safety guards

Actuators must be ordered separately.

1. SAFETY SWITCHES WITH SEPARATE ACTUATOR

AZ 17 – ACTUATORS AND ACCESSORIES





AZ 17/170-B1 *	AZ 17/170-B1-2245	AZ 17/170-B5 *
 <ul style="list-style-type: none"> ■ Straight actuator ■ Also with individual coding * 	 <ul style="list-style-type: none"> ■ Actuator with rubber mounting ■ Standard coding 	 <ul style="list-style-type: none"> ■ Angled actuator ■ Also with individual coding *
AZ 17/170-B11	AZ 17/170-B15	AZ 17-B6
 <ul style="list-style-type: none"> ■ Long straight actuator ■ Standard coding 	 <ul style="list-style-type: none"> ■ Long angled actuator ■ Standard coding 	 <ul style="list-style-type: none"> ■ Flexible actuator ■ Standard coding
B6R *	B6L *	
 <ul style="list-style-type: none"> ■ Flexible actuator for right-hand side door hinge ■ Individual coding * 	 <ul style="list-style-type: none"> ■ Flexible actuator for left-hand side door hinge ■ Individual coding * 	

* The actuators with individual coding cannot be delivered individually.

1. SAFETY SWITCHES WITH SEPARATE ACTUATOR

AZ 17 – ACTUATORS AND ACCESSORIES



AZ 17-B25-R-G1 101175202	AZ 17-B25-R-G2 101175228	MP AZ 17/170-B25 101175190
 <ul style="list-style-type: none"> ■ Door-handle actuator with star grip ■ For door hinge on the right-hand side 	 <ul style="list-style-type: none"> ■ Door-handle actuator with T-grip ■ For door hinge on the right-hand side 	 <ul style="list-style-type: none"> ■ Mounting plate ■ Accessories only for door-handle actuator AZ 17-B25-..
Centering device	Tamperproof screws	AZM 170-B 101208493
 <ul style="list-style-type: none"> ■ Centering device for pre-positioning ■ Mounting outside: TFA-020 101172607 ■ Mounting inside: TFI-020 101172609 	 <ul style="list-style-type: none"> ■ Tamperproof screws with unidirectional slots M4 x 8 101147463 ■ Quantity 2 pcs 	 <ul style="list-style-type: none"> ■ Centering guide ■ Only in combination with long actuator
MS AZ 17 ...		
 <ul style="list-style-type: none"> ■ Mounting set only in combination with AZ 17-B6 ■ Mounting parallel to safety guard: MS AZ 17 P 101150363 ■ Mounting right-angled to safety guard: MS AZ 17 R/P 101149212 		

1. SAFETY SWITCHES WITH SEPARATE ACTUATOR

AZ 3350 – SELECTION OF THE ACTUATORS



Actuator type	Actuator description	Designed for					Type designation	Material number
			R _{min} [mm]	d [mm]	R _{min} [mm]	d [mm]		
Flexible actuator	With rubber mountings		---	---	350	28	AZ 3350-B1R	101214019
	With rubber mountings and angled		---	---	350	22	AZ 3350-B5R	101214020
	Included in standard version		650	55	400	55	AZ 3350-B6	101214016
	Standard with rear-side fixing		650	49	400	49	AZ 3350-B6H	101214017
Straight actuator	With rubber mountings		---	---	---	---	AZ 3350-B1	101214015
	With rubber mountings and angled		---	---	---	---	AZ 3350-B5	101214018

Actuating radii

The axis of the hinge must be d [mm] above and in a parallel plane to the top surface of the safety switch. The basis setting provides a minimum radius of R_{min} [mm].

Key







- Actuating radius over the small edge of the actuator
- Actuating radius over the wide edge of the actuator
- Sliding and removable safety guards
- Hinged safety guards

Actuators must be ordered separately.

1. SAFETY SWITCHES WITH SEPARATE ACTUATOR

AZ 3350 – ACTUATORS AND ACCESSORIES



AZ 3350-B1	101214015	AZ 3350-B1R	101214019	AZ 3350-B5	101214018
 <ul style="list-style-type: none"> ■ Straight actuator with rubber mounting ■ Particularly suitable for sliding safety guards 	 <ul style="list-style-type: none"> ■ Flexible actuator with rubber mounting ■ Particularly suitable for hinged safety guards 	 <ul style="list-style-type: none"> ■ Angled actuator with rubber mounting ■ Particularly suitable for sliding safety guards 			
AZ 3350-B5R	101214020	AZ 3350-B6	101214016	AZ 3350-B6H	101214017
 <ul style="list-style-type: none"> ■ Angled actuator with rubber mounting ■ Particularly suitable for hinged safety guards 	 <ul style="list-style-type: none"> ■ Flexible actuator ■ Particularly suitable for hinged safety guards 	 <ul style="list-style-type: none"> ■ Flexible actuator ■ Particularly suitable for hinged safety guards 			

1. SAFETY SWITCHES WITH SEPARATE ACTUATOR

AZ 415 – SELECTION OF THE ACTUATORS



Actuator type	Actuator description	Designed for					Type designation	Material number
			R _{min} [mm]	d [mm]	R _{min} [mm]	d [mm]		
Flexible actuator	For very small actuating radius over the wide edge of the actuator		---	---	250	36	AZ/AZM 415-B2	101144796
	For very small actuating radius over the small edge of the actuator		250	36	---	---	AZ/AZM 415-B3	101144797
Straight actuator	For sliding safety guards		---	---	---	---	AZ/AZM 415-B1	101128545

Actuating radii

The axis of the hinge must be d [mm] above and in a parallel plane to the top surface of the safety switch. The basis setting provides a minimum radius of R_{min} [mm].

Key

- Actuating radius over the small edge of the actuator
- Actuating radius over the wide edge of the actuator
- Sliding and removable safety guards
- Hinged safety guards

Actuators must be ordered separately.

1. SAFETY SWITCHES WITH SEPARATE ACTUATOR

AZ 415 – ACTUATORS AND ACCESSORIES



AZ/AZM 415-B1	101128545	AZ/AZM 415-B2	101144796	AZ/AZM 415-B3	101144797
 <ul style="list-style-type: none"> ■ Straight actuator ■ For sliding safety guards 	 <ul style="list-style-type: none"> ■ Flexible actuator ■ Particularly suitable for hinged safety guards ■ For very small actuating radius over the wide edge of the actuator 	 <ul style="list-style-type: none"> ■ Flexible actuator ■ Particularly suitable for hinged safety guards ■ For very small actuating radius over the small edge of the actuator 			
AZ/AZM 415-B4PS	101142540	SZ AZ 415 22-		MP AZ 415	101142442
 <ul style="list-style-type: none"> ■ For sliding safety guards ■ With locking bolt and ball latch 	 <ul style="list-style-type: none"> ■ Lockout tag with 7 bore holes ■ SZ AZ 415-22-1 101160461 ■ SZ AZ 415-22-2 101160462 	 <ul style="list-style-type: none"> ■ Mounting plate ■ For simple mounting ■ Subsequent adjustment enabled ■ Suitable for all conventional profile systems 			

1. SAFETY SWITCHES WITH SEPARATE ACTUATOR

AZ 201 – SELECTION OF THE ACTUATORS



Series	Door hinge		Emergency exit		Type	Material number
	Left	Right	P0			
AZ/AZM 201-B1	■				AZ/AZM201-B1-LT	103013493
				■	AZ/AZM201-B1-LTP0	103013496
		■			AZ/AZM201-B1-RT	103013494
				■	AZ/AZM201-B1-RTP0	103013495

Series	Door hinge		Mounted		Door handle		Rotating knob				Emergency exit		Locking rod	Lockout tag	Type	Material number				
	Left	Right	Inside	Outside	G1	G2	without	Included in standard version	Metal film	Metal film	P30/P31									
								P1	P20	P25										
AZ/AZM 201-B30	■		■		■			■							AZ/AZM201-B30-RTIG1P1	103025195				
							■								AZ/AZM201-B30-LTAG1	103013501				
				■														AZ/AZM201-B30-LTAG1P1	103013498	
																■		AZ/AZM201-B30-LTAG1P1-SZ	103013500	
													■					AZ/AZM201-B30-LTAG1P20	103027215	
														■				AZ/AZM201-B30-LTAG1P20-SZ	103026322	
															■			AZ/AZM201-B30-LTAG1P25	103028172	
																■		AZ/AZM201-B30-LTAG1P30	103015820	
																■		AZ/AZM201-B30-LTAG1P31	103015821	
																■	■	AZ/AZM201-B30-LTAG1P31-SZ	103015822	
		■		■		■	■	■								AZ/AZM201-B30-LTAG2	103030662			
									■									AZ/AZM201-B30-LTAG2P1	103025248	
													■						AZ/AZM201-B30-LTIG1P1	103025197
													■						AZ/AZM201-B30-RTAG1	103013502
														■					AZ/AZM201-B30-RTAG1P1	103013497
																	■		AZ/AZM201-B30-RTAG1P1-SZ	103013499
														■					AZ/AZM201-B30-RTAG1P20-SZ	103026321
															■				AZ/AZM201-B30-RTAG1P25	103028173
																	■		AZ/AZM201-B30-RTAG1P30	103015823
																	■		AZ/AZM201-B30-RTAG1P31	103015824
											■	■	AZ/AZM201-B30-RTAG1P31-SZ	103015825						
								■					AZ/AZM201-B30-RTAG2P1	103025247						

Actuators must be ordered separately. Further actuator versions AZ/AZM201-B30 are available on request.

1. SAFETY SWITCHES WITH SEPARATE ACTUATOR

AZ 201 – ACTUATORS AND ACCESSORIES



<p>AZ/AZM201-B1-...</p>  <ul style="list-style-type: none"> ■ Actuator for sliding safety guards ■ Left-hand side actuating direction AZ/AZM201-B1-LT 103013493 ■ Right-hand side actuating direction AZ/AZM201-B1-RT 103013494 	<p>AZ/AZM201-B1-...-P0</p>  <ul style="list-style-type: none"> ■ With emergency exit P0 ■ Left-hand side actuating direction AZ/AZM201-B1-LTP0 103013496 ■ Right-hand side actuating direction AZ/AZM201-B1-RTP0 103013495 	<p>AZ/AZM201-B30-...-P30/P31</p>  <ul style="list-style-type: none"> ■ Three point locking linkage for requirements with increased mechanical stability (7,000 N)
<p>AZ/AZM201-B30-... -G1</p>  <ul style="list-style-type: none"> ■ Actuator for hinged safety guards 	<p>AZ/AZM201-B30-...-SZ</p>  <ul style="list-style-type: none"> ■ Actuator B30 with lockout tag 	<p>AZ/AZM201-B30-...-G2</p>  <ul style="list-style-type: none"> ■ Actuator with rotating knob
<p>AZ/AZM201-...-P1</p>  <ul style="list-style-type: none"> ■ Emergency exit 	<p>AZ/AZM201-...-P20</p>  <ul style="list-style-type: none"> ■ Emergency exit (metal) 	<p>AZ/AZM201-...-P25</p>  <ul style="list-style-type: none"> ■ Emergency exit (metal)

The actuation system selection can be found at products.schmersal.com.

1. SAFETY SWITCHES WITH SEPARATE ACTUATOR

AZ 201 – ACCESSORIES



SZ 200-1	101196397	SZ 200	101194438
 <ul data-bbox="121 730 427 808" style="list-style-type: none">■ Lockout tag with 6 bore holes■ To prevent inadvertent closing, e.g. during maintenance	 <ul data-bbox="576 730 882 808" style="list-style-type: none">■ Lockout tag with 5 bore holes■ To prevent inadvertent closing, e.g. during maintenance		

UP-TO-DATE WITHOUT FAIL THE SCHMERSAL WEBSHOP

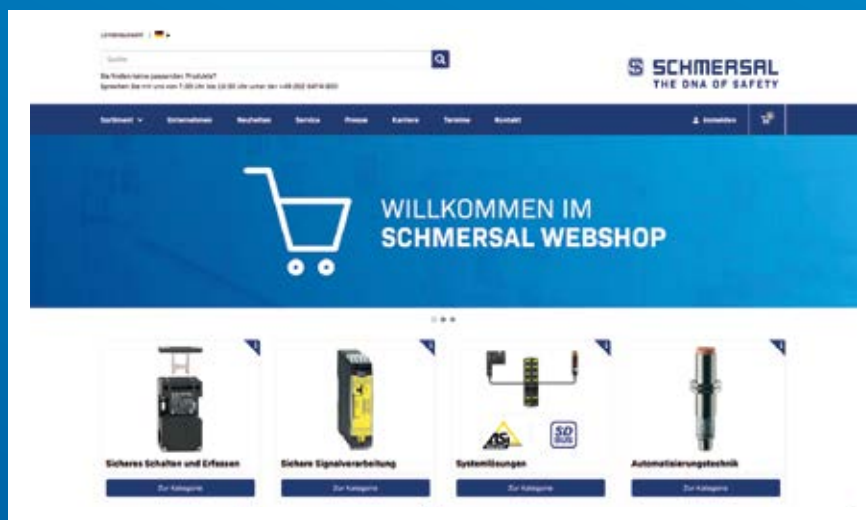

FOR DETAILED INFORMATION, CHECK OUT
[PRODUCTS.SCHMERSAL.COM](https://products.schmersal.com)

2. SOLENOID INTERLOCKS DESCRIPTION

AREA OF APPLICATION

The solenoid interlocks of the AZM and MZM series have been designed to prevent sliding, hinged and removable safety guards (fences, flaps or doors) from being opened before hazardous conditions (e.g. run-on movements from rollers, chains, shafts etc) have been eliminated. This task is to perform in conjunction with an appropriate safety relay module, such as a fail-safe standstill monitor or a safe timer.

In addition to this application field of occupational safety, interlocks are also used in cases where the opening of a safety device causes an impermissible or unwanted intrusion into a production process (process protection).

DESIGN AND WAY OF FUNCTIONING

The solenoid interlock of the Schmersal Group is based on the principle of separate actuators: The actuator element is fixed in the moveable part (mostly a safety door) of the guard system. The interlock itself is fixed, such as on the post of a safety door. Shutting the safety equipment immerses the actuator in the device and interlock locks the safety door. Only then can the machine be started. The position of the locked actuator is continuously being monitored.

When the safety guard is opened in the unlocked condition, the actuator is separated from the base unit. During this process, the NC contacts are positively opened and the NO contacts closed.

There are three interlocking principles: The "Power to unlock" principle is where the locking bolt is held into position with a spring. By energising the interlocking solenoid coil, the interlock unlatches and the NC contact is opened, and the protection equipment can be opened. With the working "Power to lock" principle, the operation is reversed. For the selection of the principle, an analysis of the accident risk has to be made, as you should be able to open the protection equipment in the event of a fault (e.g. broken cable) or with a loss of power. With the bistable active principle, the interlock maintains the last locked status in the event of a power failure. Safe operation is assured in any operating condition of the machine as even if the system is in a run-down movement and presents a danger, the safety door remains securely closed if power has been cut-off.

The solenoid interlocks, the safety switches and the safety sensors have all belonged to the core program of the Schmersal Group for decades. The variety of designs and product ranges is correspondingly large.

The solenoid interlocks AZM150, AZM 161, 170, 190 and 415 are fitted with protection against incorrect locking. The AZM150 also impresses with its actuating head, which can be easily rotated by 4x90°, and the resulting wide range of possible applications.

The AZM201 Series is integrated with position monitoring of the safety door, interlock, door handle and if necessary other functions such as the emergency release in an installation friendly, ergonomic operated system.

The AZM300 Series is characterised by a novel interlock system and an RFID-based safe detection of the actuator position.



Due to its small dimensions, the AZM40 series is particularly suitable for small protective doors and flaps and, thanks to the angle flexibility, enables a wide variety of installation options.

The AZM400 series is a safe bolt interlock with bistable principle of operation or a motor-driven locking bolt. With the series MZM 100, non-contact-acting solenoid interlocks are also available in which the clamping force is generated electromagnetically and is continually monitored.

In several series (AZM40, AZM201, AZM300, AZM400, MZM100) the monitoring of the safety door position is not electromechanical, but non-contact – either with the Schmersal developed "Coded Safety Sensor Technology" or by a safety-reinforced RFID-technology. These models offer the advantage that they provide the machine operator with additional diagnostic information. Clamping forces of up to 10,000 N are possible. For some series, the latching force (i.e. the non-safety-related clamping force) can be adjusted.

Depending on the type of device, an individual coding of the actuator is possible. The RFID-technology offers the advantage that the user can select from different types of coding. The basic version accepts any suitable target. A second version only accepts the actuator for which the teach-in process was run during initial activation (I1 variant). A third version is now also available which responds to an individually-assigned actuator only. This kind of teach-in process can be repeated any number of times (I2-variant). This means that for individually-coded variants I1 and I2 the coding level "high" is fulfilled in accordance with EN ISO 14119, thereby ensuring a high level of manipulation protection for doors which are at particular risk of interference.

In addition, the solenoid interlock program offers a wide variety of additional features that are either integrated or available as an option. In addition to safety functions such as manual release and emergency release ("emergency handle" and Bowden cable), this also includes integrated door hinges and door handles, for example. An extensive range of accessories as well as different plug and line variants round off the program.

The electromechanical solenoid interlocks AZM150, AZM161 and AZM170 are also available as individually-coded versions with more than 1,000 different coding variants, achieving coding level "high" in accordance with EN ISO 14119.

To do this, the switch is supplied with the corresponding actuator, which is specially adapted to the respective switch. Manipulation by a substitute actuator is not possible.

Information for the selection of suitable safety relay modules can be found in the chapter "Safety relay modules" (refer to page 220).

Versions with integrated "AS-Interface Safety at Work" interface, as well as models with ATEX certification are also available.

2. SOLENOID INTERLOCKS

OVERVIEW OF THE SERIES



■ AZM150



■ AZM161

Key Features

- Thermoplastic enclosure
- Individual coding possible
- Holding force 1,500 N
- Power to unlock / Power to lock
- 4 contacts (2 actuators / 2 magnets)
- Manual release, emergency exit or emergency release
- Screw terminals

- Thermoplastic enclosure
- Individual coding possible
- Holding force 2,000 N
- Power to unlock / Power to lock
- Up to 6 contacts
- Manual release, emergency exit or emergency release
- Cut clamps, screw terminals or connector plug

Other versions

ATEX / IECEx	–	■
AS-i SaW (see page 258)	–	■
SD interface (see page 270)	–	–

Technical features

Electrical characteristics		
Holding force F_{Zh}/F_{max}	1,500 N / 1,950 N	2,000 N / 2,600 N
Operating voltage	24 VDC 110/230 VAC	24 VAC/DC 110/230 VAC
Operating current	–	–
Max. switching capacity U/I	230 VAC / 4 A; 24 VDC / 2.5 A	230 VAC / 4 A; 24 VDC / 2.5 A
Mechanical data		
Dimensions (W x H x D)	40 x 204 x 48 mm	130 x 90 x 30 mm
Ambient conditions		
Ambient temperature	–25 °C ... +55 °C	–25 °C ... +60 °C
Degree of protection	IP65, IP66, IP67	IP67
Actuator and accessories refer to ...	Page 46	Page 46

Safety classification of the interlocking function

Standards	EN ISO 13849-1	EN ISO 13849-1
B_{10D} NC contact	2,000,000	2,000,000
PL/ SIL	–/–	–/–
Control category	–	–
PFH	–	–
Certificates	TÜV, cULus, CCC, EAC	BG, cULus, CCC, EAC



To get detailed information about the products and certificates, visit products.schmersal.com.



■ AZM 170



■ AZM 190



■ AZM 415

- Thermoplastic enclosure
- Compact design
- Individual coding possible
- Holding force 1,000 N
- Power to unlock / Power to lock
- Up to 5 contacts
- Manual release from side
- Cut clamps, screw terminals or connector plug

- Thermoplastic enclosure
- Holding force 1,950 N
- Power to unlock / Power to lock
- 3 contacts
- Manual release or emergency release
- Screw terminals

- Metal enclosure
- Holding force 3,500 N
- Power to unlock / Power to lock
- Up to 6 contacts
- Manual release or emergency release
- Screw terminals or connector
- Robust design

■

■

-

-

-

-

■

-

-

1,000 N / 1,300 N
24 VAC/DC
110/230 VAC

-

230 VAC / 4 A;
24 VDC / 4 A

90 x 100.5 x 30 mm

-25 °C ... +60 °C

IP67

Page 51

1,950 N / 2,550 N
24 VAC/DC
48/110/230 VAC

-

230 VAC / 4 A;
24 VDC / 4 A

89 x 178 x 41 mm

0 °C ... +50 °C

IP67, suffix N: IP65

Page 54

3,500 N / 4,550 N
24 VAC/DC
110/230 VAC

-

230 VAC / 4 A

130 x 100 x 46.5 mm

-25 °C ... +50 °C

IP67; suffix NS, RS: IP54

Page 56

EN ISO 13849-1
2,000,000

-/-

-

-

BG, cULus, CCC, EAC

EN ISO 13849-1
2,000,000

-/-

-

-

TÜV, cULus, EAC

EN ISO 13849-1
2,000,000

-/-

-

-

BG, cULus, CCC

2. SOLENOID INTERLOCKS

OVERVIEW OF THE SERIES



■ AZM 40



■ AZM 201

Key Features

- | | |
|---|--|
| <ul style="list-style-type: none"> • Metal / thermoplastic enclosure • Individual coding possible • Holding force 2,000 N • 2 safety outputs and 1 diagnostic output • Actuator can approach interlock continuously within a 180 degree angle. • RFID-technology for needs-based protection against tampering | <ul style="list-style-type: none"> • Thermoplastic enclosure • Individual coding possible • Holding force 2,000 N • 2 safety outputs and 1 diagnostic output • Manual release, emergency exit or emergency release (suitable for retrofitting) • Cut clamps, screw terminals or connector plug |
|---|--|

Other versions

ATEX / IECEx	-	-
AS-i SaW (see page 258)	-	■
SD interface (see page 270)	-	■

Technical features

Electrical characteristics		
Holding force F_{Zh}/F_{max}	2,000 N / 2,600 N	2,000 N / 2,600 N
Operating voltage	24 VDC	24 VDC
Operating current	0.6 A (without load)	0.7 A (without load)
Max. switching capacity U/I	24 VDC / 0.25 A	24 VDC / 0.25 A
Mechanical data		
Dimensions (W x H x D)	119.5 x 40 x 20 mm	40 x 220 x 50 mm
Ambient conditions		
Ambient temperature	0 °C ... +55 °C	-25 °C ... +60 °C
Degree of protection	IP66, IP67	IP66, IP67
Actuator and accessories refer to ...	Page 58	Page 60

Safety classification of the interlocking function

Standards	EN ISO 13849-1, IEC 61508	EN ISO 13849-1, IEC 61508
B_{100} NC contact	-	-
PL/ SIL	e/3	e/3
Control category	4	4
PFH	$1.1 \times 10^{-9}/h$	$1.9 \times 10^{-9}/h$
Certificates	TÜV, cULus	TÜV, cULus, EAC



To get detailed information about the products and certificates, visit products.schmersal.com.



■ AZM 300



■ AZM 400



■ MZM 100

- Thermoplastic enclosure
- Individual coding possible
- Holding force 1,150 N
- 2 safety outputs and 1 diagnostic output
- Manual release, emergency exit, emergency release or Bowden cable release
- 3 different directions of actuation

- Metal enclosure
- Solenoid interlock with bolt locking
- Bistable principle of operation
- Individual coding possible
- Holding force 10,000 N, unlocking against lateral force (< 300 N)
- 2 safety outputs and up to 2 diagnostic outputs
- Manual/electrical auxiliary release, emergency exit or Bowden cable release
- Two-channel unlocking signal



- Thermoplastic enclosure
- Holding force 750 N
- Power to lock
- 2 safety outputs and 1 diagnostic output
- Can be used as an end stop

-	-	-
■	-	■
■	-	■

1,150 N / 1,500 N 24 VDC	10,000 N / 13,000 N 24 VDC	$F_{\text{typically}} = 750 \text{ N}$ 24 VDC
0.25 A (without load) 24 VDC / 0.25 A	0.6 A (without load) 24 VDC / 0.25 A	0.6 A (without load) 24 VDC / 0.25 A
88 x 135 x 35 mm	78 x 157 x 47 mm	40 x 179 x 40 mm
0 °C ... +60 °C IP66, IP67, IP69 Page 62	-20 °C ... +55 °C IP66, IP67 Page 62	-25 °C ... +55 °C IP65, IP67 Page 63

EN ISO 13849-1, IEC 61508	EN ISO 13849-1, IEC 61508	EN ISO 13849-1, IEC 61508
-	-	-
e/3	e/3	e/3
4	4	4
$5.2 \times 10^{-10}/\text{h}$	$1.0 \times 10^{-9}/\text{h}$	$3.54 \times 10^{-9}/\text{h}$
TÜV, cULus, EAC	TÜV, cULus	TÜV, cULus, EAC

2. SOLENOID INTERLOCKS PREFERRED TYPES

Range	Coding	Termination	Latching force	Magnet contacts	Actuator contact		
AZM 150 	Standard coding	Screw terminals	50 N	2 NC	2 NC		
					1 NO / 1 NC		
					2 NC		
					1 NO / 1 NC		
	Individual coding				1 NO / 1 NC	2 NC	
						2 NC	1 NO / 1 NC
AZM 161 	Standard coding	Cage clamps	50 N	1 NO / 2 NC	1 NO / 2 NC		
					Screw terminals	1 NO / 2 NC	3 NC
		Individual coding					1 NO / 2 NC
					Standard coding		
				1 NO / 2 NC		1 NO / 1 NC	
	AZM 170 	Standard coding	Connector	30 N	---	2 NC	
Cut clamps						5 N	---
			Individual coding				
Standard coding						Screw terminals	



					2 NC	1 NO	

A variety of other types of the solenoid interlocks can be found at products.schmersal.com.

Special features	Included in delivery	Power to lock	Power to unlock	Type designation	Material number			
Manual release	---		■	AZM150SK-02/02R-024	153032120			
		■		AZM150SK-02/02RA-024	153032126			
			■	AZM150SK-02/11R-024	153032125			
		■		AZM150SK-02/11RA-024	153032163			
Emergency Exit		---		■	AZM150SK-02/02RT-024	153032164		
				■	AZM150SK-02/02RT-230	153032165		
				■	AZM150SK-02/02RT-024	153032167		
Emergency release			---		■	AZM150SK-02/02RN-024	153032171	
				■	AZM150SK-02/02RN-230	153032173		
Manual release	Actuator B6			■		AZM150SK-11/02RIA-024-B6L	153032215	
						AZM150SK-11/02RIA-024-B6R	153032230	
					■	AZM150SK-02/11RI-B6L	153032213	
				■	AZM150SK-02/11RI-B6R	153032228		
Emergency Exit		Actuator B6				AZM150SK-02/11RIT-B6L	153032221	
					■	AZM 161CC-12/03RK-024	101195902	
Manual release			---		■	AZM 161CC-12/12RK-024	101166283	
				■		AZM 161CC-12/12RKA-110/230	101166288	
Emergency Exit	---				■	AZM 161CC-12/12RKT-024	101187882	
					■	AZM 161CC-12/12RKTU-024	101187884	
Manual release				---		■	AZM 161SK-12/03RK-024	101195886
						■	AZM 161SK-12/03RKA-024	101195892
					■	AZM 161SK-12/12RK-024	101164207	
		■				AZM 161SK-12/12RKA-024	101166285	
Emergency Exit		---				AZM 161SK-12/12RKEU-024	101187819	
					■	AZM 161SK-12/12RKT-024	101177876	
			■		AZM 161SK-12/12RKT-024	101187838		
			■		AZM 161SK-12/12RKTU-024	101187849		
Manual release	Actuator B1				AZM 161SK-12/12RI-024-B1	101213351		
	Actuator B6L				AZM 161SK-12/12RI-024-B6L	101215900		
	Actuator B6R				AZM 161SK-12/12RI-024-B6R	101215869		
	---		■		AZM 161ST-11/12RKA-024	101192434		
Manual release	---		■	AZM 161ST-12/11RK-024	101192414			
			■	AZM 170-02ZRK-ST-2197 24VAC/DC	101141430			
		■		AZM 170-02ZRKA-ST 24VAC/DC	101141422			
			■	AZM 170-11ZRK-ST-2197 24VAC/DC	101141425			
		■		AZM 170-11ZRKA-ST 24VAC/DC	101141455			
			■	AZM 170-02ZRK 24VAC/DC	101140795			
		■		AZM 170-02ZRKA 24VAC/DC	101141020			
			■	AZM 170-11ZK 24VAC/DC	101141639			
			■	AZM 170-11ZRK 24VAC/DC	101140788			
			■	AZM 170-11ZRK-2197 24VAC/DC	101140813			
		■		AZM 170-11ZRKA 24VAC/DC	101140796			
				■	AZM 170-02ZRI B1 24VAC/DC	101140798		
				■	AZM 170-02ZRI B6L 24VAC/DC	101140810		
				■	AZM 170-02ZRI B6R 24VAC/DC	101140806		
				■	AZM 170SK-02ZRK-2197 24VAC/DC	101144261		
				■	AZM 170SK-02ZRKA 24VAC/DC	101144263		
		■	AZM 170SK-11ZRK-2197 24VAC/DC	101144260				
		■	AZM 170SK-11ZRKA 24VAC/DC	101144262				
			■	AZM 170SK-02/10ZRK-2197 24VAC/DC	101181883			

2. SOLENOID INTERLOCKS

PREFERRED TYPES

Range	Coding	Termination	Latching force	Magnet contacts	Actuator contact
AZM 190 	Standard coding	Screw terminals	20 N	2 NC	1 NC
				2 NC	1 NO
				1 NO / 1 NC	1 NC
AZM 415 	Standard coding	Screw terminals	150...400 N	1 NO / 1 NC	1 NO / 1 NC
				2 NC	1 NO / 1 NC
				1 NO / 1 NC	2 NO / 2 NC

A variety of other types of the solenoid interlocks can be found at products.schmersal.com.

Special features	Included in delivery	Power to lock	Power to unlock	Type designation	Material number
Manual release	---		■	AZM190-02/01RK 230VAC	131182119
				AZM190-02/01RK 24VDC	131178901
		■		AZM190-02/01RKA 24VDC	131031685
			■	AZM190-02/10RK 24VDC	131029960
		■		AZM190-02/10RKA 24VAC	131030182
				AZM190-02/10RKA 24VDC	131030003
			■	AZM190-11/01RK 230VAC	131029963
		■		AZM190-11/01RK 24VDC	131029937
---	---		■	AZM 415-11/11ZPK 24 VAC/DC	101167205
				AZM 415-11/11ZPK 230 VAC	101167204
Emergency exit	---	■		AZM 415-11/11ZPKA 24 VAC/DC	101167206
Manual release			■	AZM 415-11/11ZPKT 24 VAC/DC	101167201
Emergency exit			■	AZM 415-11/11ZPKE 24 VAC/DC	101167190
Manual release			■	AZM 415-11/11ZPKF 24 VAC/DC	101167209
Emergency exit				AZM 415-02/11ZPKT 24 VAC/DC	101168224
Manual release				AZM 415-33ZPDK 24 VAC/DC	101135487



2. SOLENOID INTERLOCKS PREFERRED TYPES

Range	Coding	Termination	Latching force	Diagnostic and safety outputs
AZM40 	Standard coding	M12 connector	40 N	1 diagnostic output and 2 safety outputs, all p-type
	Individual coding			
	Individual coding, re-teaching enabled			
AZM 201 	Standard coding	Screw terminals	30 N	1 diagnostic output and 2 safety outputs, all p-type, combined diagnostic signal
		Connector		Serial diagnostic output and 2 safety outputs, all p-type
		M12 connector		1 diagnostic output and 2 safety outputs, all p-type, combined diagnostic signal
		Cage clamps		Serial diagnostic output and 2 safety outputs, all p-type
		Individual coding		Screw terminals
	M12 connector			Serial diagnostic output and 2 safety outputs, all p-type
	Individual coding, re-teaching enabled	Cage clamps		Serial diagnostic output and 2 safety outputs, all p-type
		Screw terminals		1 diagnostic output and 2 safety outputs, all p-type, combined diagnostic signal
		M12 connector		Serial diagnostic output and 2 safety outputs, all p-type

A variety of other types of the solenoid interlocks can be found at products.schmersal.com.

Special features	Guard locking monitored	Actuator monitoring	Power to lock	Power to unlock	Type designation	Material number												
---	■				AZM40Z-ST-1P2P	103034187												
Flat enclosure for protruding screws	■				AZM40Z-ST-1P2P-PH	103037333												
---		■			AZM40B-ST-1P2P	103034193												
Flat enclosure for protruding screws		■			AZM40B-ST-1P2P-PH	103037330												
---	■				AZM40Z-I1-ST-1P2P	103034188												
Flat enclosure for protruding screws	■				AZM40Z-I1-ST-1P2P-PH	103037334												
---		■			AZM40B-I1-ST-1P2P	103034194												
Flat enclosure for protruding screws		■			AZM40B-I1-ST-1P2P-PH	103037331												
---	■				AZM40Z-I2-ST-1P2P	103034189												
Flat enclosure for protruding screws	■				AZM40Z-I2-ST-1P2P-PH	103037335												
---		■			AZM40B-I2-ST-1P2P	103034195												
Flat enclosure for protruding screws		■			AZM40B-I2-ST-1P2P-PH	103037332												
Manual release	■		■		AZM201Z-SK-T-1P2PW-A	103016752												
				■	AZM201B-SK-T-1P2PW	103013910												
	■			■		AZM201B-SK-T-1P2PW-A	103013911											
					■	AZM201Z-SK-T-1P2PW	103013908											
Idle assignable pushbutton and LED	■			■		AZM201Z-SK-T-SD2P	103032241											
					■	AZM201Z-ST-T-1P2PW-2965-1	103025499											
Manual release		■			■	AZM201Z-ST-T-1P2PW-A-2965-1	103025498											
						■	AZM201B-ST2-T-1P2PW	103032935										
	■					■	AZM201B-ST2-T-1P2PW-A	103031956										
						■	AZM201Z-ST2-T-1P2PW	103013909										
						■	AZM201Z-ST2-T-1P2PW-A	103016753										
						■	AZM201Z-ST2-T-SD2P	103032731										
						■	AZM201Z-ST2-T-SD2P-A	103032732										
						■	AZM201Z-CC-T-1P2PW	103013912										
						■	AZM201Z-CC-T-1P2PW-A	103017023										
						■	AZM201Z-I1-SK-T-1P2PW	103013483										
	■					■	AZM201Z-I1-ST2-T-1P2PW	103013485										
						■	AZM201B-I2-CC-T-1P2PW	103013488										
						■					■	AZM201Z-I2-CC-T-1P2PW	103013487					
											■	AZM201Z-I2-CC-T-1P2PW-A	103017027					
						■					■	AZM201Z-I2-CC-T-SD2P	103032138					
												■	AZM201B-I2-SK-T-1P2PW	103013490				
											■					■	AZM201B-I2-SK-T-1P2PW-A	103013491
																■	AZM201Z-I2-SK-T-1P2PW	103013484
	■					■	AZM201Z-I2-SK-T-1P2PW-A	103016780										
							■	AZM201Z-I2-ST2-T-1P2PW	103013486									
■					■	AZM201Z-I2-ST2-T-1P2PW-A	103013489											
						■	AZM201B-I2-ST2-T-1P2PW-A	103025461										
■					■	AZM201Z-I2-ST2-T-SD2P	103013492											

2. SOLENOID INTERLOCKS PREFERRED TYPES

Range	Coding	Termination	Latching force	Diagnostic and safety outputs
AZM 300 	Standard coding	M12 connector	25 N / 50 N	1 diagnostic output and 2 safety outputs, all p-type
				1 diagnostic output and 2 safety outputs, all p-type
	Individual coding			Serial diagnostic output and 2 safety outputs, all p-type
				1 diagnostic output and 2 safety outputs, all p-type
AZM 400 	Standard coding	1 connector plug M12, 8-pole	Unlocking against lateral forces up to 300 N	1 diagnostic output and 2 safety outputs, all p-type
		2 connector plugs M12, 5- and 8-pole		2 diagnostic output and 2 safety outputs, all p-type
	Individual coding	1 connector plug M12, 8-pole		1 diagnostic output and 2 safety outputs, all p-type
		2 connector plugs M12, 5- and 8-pole		2 diagnostic output and 2 safety outputs, all p-type
	Individual coding, re-teaching enabled	1 connector plug M12, 8-pole		1 diagnostic output and 2 safety outputs, all p-type
		2 connector plugs M12, 5- and 8-pole		2 diagnostic output and 2 safety outputs, all p-type

A variety of other types of the solenoid interlocks can be found at products.schmersal.com.

Special features	Guard locking monitored	Actuator monitoring	Power to lock	Power to unlock	Type designation	Material number
Manual release		■		■	AZM300B-ST-1P2P	103001411
			■		AZM300B-ST-1P2P-A	103001423
	■			■	AZM300Z-ST-1P2P	103001435
			■		AZM300Z-ST-1P2P-A	103001450
Emergency Exit	■			■	AZM300Z-I2-ST-1P2P-T	103006863
			■		AZM300Z-ST-1P2P-T	103006865
		■		■	AZM300B-ST-1P2P-T	103006862
Emergency release	■			■	AZM300Z-ST-1P2P-N	103006869
				■	AZM300B-ST-1P2P-N	103006867
Emergency Exit	■			■	AZM300Z-ST-SD2P-T	103008117
				■	AZM300B-ST-SD2P-T	103008176
				■	AZM300B-ST-SD2P	103001412
Manual release		■		■	AZM300B-ST-SD2P-A	103001424
			■		AZM300Z-ST-SD2P	103001436
	■			■	AZM300Z-ST-SD2P-A	103001451
			■		AZM300B-ST-SD2P	103001412
Manual release		■		■	AZM300B-I2-ST-1P2P	103001415
			■		AZM300B-I2-ST-1P2P-A	103001427
	■			■	AZM300Z-I2-ST-1P2P	103001439
			■		AZM300Z-I2-ST-1P2P-A	103001454
Emergency Exit				■	AZM300Z-I2-ST-SD2P-T	103008178
				■	AZM300B-I2-ST-SD2P-T	103008179
Manual release		■		■	AZM300B-I2-ST-SD2P	103001416
			■		AZM300B-I2-ST-SD2P-A	103001428
	■			■	AZM300Z-I2-ST-SD2P	103001440
			■		AZM300Z-I2-ST-SD2P-A	103001455
Manual release	■			Bistable principle of operation	AZM400Z-ST-1P2P	103003590
Manual release, Bowden cable					AZM400Z-ST-1P2P-BOW *	103015314
Emergency Exit					AZM400Z-ST-1P2P-T	103003593
Manual and electrical release					AZM400Z-ST2-2P2P-E	103003588
Manual and electric release, Bowden cable					AZM400Z-ST2-2P2P-BOW-E *	103015312
Emergency exit and electric release					AZM400Z-ST2-2P2P-T-E	103003591
Manual release					AZM400Z-ST-I1-1P2P	103003732
Emergency Exit					AZM400Z-ST-I1-1P2P-T	103003840
Manual and electrical release					AZM400Z-ST2-I1-2P2P-E	103003724
Emergency exit and electric release					AZM400Z-ST2-I1-2P2P-T-E	103003835
Manual release					AZM400Z-ST-I2-1P2P	103003733
Manual release, Bowden cable					AZM400Z-ST-I2-1P2P-BOW *	103015315
Emergency Exit					AZM400Z-ST-I2-1P2P-T	103003841
Manual and electrical release					AZM400Z-ST2-I2-2P2P-E	103003725
Manual and electric release, Bowden cable					AZM400Z-ST2-I2-2P2P-BOW-E *	103015313
Emergency exit and electric release					AZM400Z-ST2-I2-2P2P-T-E	103003836

* Only in connection with Bowden cable (available separately)

2. SOLENOID INTERLOCKS PREFERRED TYPES

Range	Coding	Termination	Latching force	Diagnostic and safety outputs
MZM 100 	Standard coding	M23 connector	---	Serial diagnostic output and 2 safety outputs, all p-type
			30 ... 100 N	1 diagnostic output and 2 safety outputs, all p-type, combined diagnostic signal
		M12 connector	15 N	
			30 ... 100 N	

A variety of other types of the solenoid interlocks can be found at products.schmersal.com.

Special features	Guard locking monitored	Actuator monitoring	Power to lock	Power to unlock	Type designation	Material number
---	■				MZM 100 ST-SD2P-A	101183538
---					MZM 100 ST-SD2PRE-A	101211143
Permanent magnet (15 N)					MZM 100 ST-SD2PREM-A	101211144
---					MZM 100 ST-1P2PWRE-A	101211064
Permanent magnet (15 N)					MZM 100 ST-1P2PWREM-A	101211065
---	■	■	■		MZM 100 B ST-1P2PW2REM-A	101211069
Permanent magnet (15 N)					MZM 100 ST2-1P2PWM-A	101209059
---					MZM 100 ST2-1P2PWRE-A	101211066
Permanent magnet (15 N)					MZM 100 ST2-1P2PWREM-A	101211067
---					MZM 100 ST2-SD2PRE-A	101211145
Permanent magnet (15 N)	■				MZM 100 ST2-SD2PREM-A	101211146
---					MZM 100 B ST2-SD2PRE-A	101211156
Permanent magnet (15 N)					MZM 100 B ST2-SD2PREM-A	101211153

2. SOLENOID INTERLOCKS

AZM 150 – ACTUATORS AND ACCESSORIES

AZM150-B1	AZM150-B5	AZM150-B6
<p data-bbox="448 342 564 371">153033699</p>  <ul style="list-style-type: none"> ■ Straight actuator ■ Also with individual coding * 	<p data-bbox="903 342 1023 371">153033700</p>  <ul style="list-style-type: none"> ■ Angled actuator ■ Also with individual coding * 	<p data-bbox="1358 342 1476 371">153033701</p>  <ul style="list-style-type: none"> ■ Flexible actuator ■ Standard coding ■ Also with individual coding *
SZ150-1		Tamperproof screws
<p data-bbox="448 880 564 913">153027887</p>  <ul style="list-style-type: none"> ■ Lockout tag for AZM150 ■ To prevent inadvertent closing, e.g. during maintenance 		 <ul style="list-style-type: none"> ■ Tamperproof screws with unidirectional slots M5 x 12 101135338 M5 x 16 101135339 M5 x 20 101135340 ■ Quantity 2 pcs

* The actuators with individual coding cannot be delivered individually.

2. SOLENOID INTERLOCKS

AZM 161 – ACTUATOR SELECTION



Actuator type	Actuator description	Designed for					Type designation	Material number
			R _{min} [mm]	d [mm]	R _{min} [mm]	d [mm]		
Flexible actuator	Included in standard version		95	11	95	11	AZM 161-B6	101144420
	For right-hand side door hinge with individual coding		95	11	95	11	AZM 161i-B6R	Included in delivery
	For left-hand side door hinge with individual coding		95	11	95	11	AZM 161i-B6L	Included in delivery
	With centering guide		95	17	95	17	AZM 161-B6-2177	101174113
	Shortened		95	---	95	---	AZM 161-B6S	101170375
Straight actuator	Included in standard version		---	---	---	---	AZM 161-B1	101145117
	Shortened		---	---	---	---	AZM 161-B1S	101171125
	With magnetic latch		---	---	---	---	AZM 161-B1-1747	101164100
	With slot lip-seal		---	---	---	---	AZM 161-B1-2024	101178199
	With ball latch		---	---	---	---	AZM 161-B1-2053	101173089
	With centering guide		---	---	---	---	AZM 161-B1-2177	101176642
	Included in standard version		---	---	---	---	AZM 161-B1E	101144416
	Shortened		---	---	---	---	AZM 161-B1ES	101171859
	Included in standard version		---	---	---	---	AZM 161-B1F	101175431
	Included in standard version		---	---	---	---	AZM 161-B1F	101175431

Actuating radii

The axis of the hinge must be d [mm] above and in a parallel plane to the top surface of the safety switch. The basis setting provides a minimum radius of R_{min} [mm].

Key

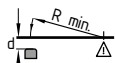

Actuating radius over the small edge of the actuator

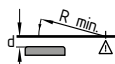

Actuating radius over the wide edge of the actuator

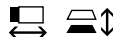

Sliding and removable safety guards



Hinged safety guards









Actuators must be ordered separately.

Detailed information regarding the actuator selection and other actuators can be found at products.schmersal.com.

2. SOLENOID INTERLOCKS

AZM 161 – ACTUATORS



AZM 161-B1 *	101145117	AZM 161-B1S	101171125	AZM 161-B1-1747 *	101164100
 <ul style="list-style-type: none"> ■ Straight actuator ■ Also with individual coding * 		 <ul style="list-style-type: none"> ■ Shortened straight actuator ■ Standard coding 		 <ul style="list-style-type: none"> ■ Straight actuator with magnetic latch ■ Also with individual coding * 	
AZM 161-B1-2024 *	101178199	AZM 161-B1-2053 *	101173089	AZM 161-B1-2177 *	101176642
 <ul style="list-style-type: none"> ■ Straight actuator with slot lip-seal ■ Also with individual coding * 		 <ul style="list-style-type: none"> ■ Straight actuator with ball latch ■ Also with individual coding * 		 <ul style="list-style-type: none"> ■ Straight actuator with centering guide ■ Also with individual coding * 	
AZM 161-B1E *	101144416	AZM 161-B1ES	101171859	AZM 161-B1F	101175431
 <ul style="list-style-type: none"> ■ Straight actuator ■ Also with individual coding * 		 <ul style="list-style-type: none"> ■ Shortened straight actuator ■ Standard coding 		 <ul style="list-style-type: none"> ■ Straight actuator ■ Standard coding 	

* The actuators with individual coding cannot be delivered individually.

2. SOLENOID INTERLOCKS

AZM 161 – ACTUATORS







AZM 161-B6	101144420	B6R *	B6L *
 <ul style="list-style-type: none"> ■ Flexible actuator ■ Standard coding 	 <ul style="list-style-type: none"> ■ Flexible actuator for right-hand side door hinge ■ Individual coding * 	 <ul style="list-style-type: none"> ■ Flexible actuator for left-hand side door hinge ■ Individual coding * 	
AZM 161-B6-2177	101174113	AZM 161-B6S	101170375
 <ul style="list-style-type: none"> ■ Flexible actuator with centering guide ■ Standard coding 	 <ul style="list-style-type: none"> ■ Shortened flexible actuator ■ Standard coding 		

* The actuators with individual coding cannot be delivered individually. Connecting and interconnecting cables are listed in the appendix.

2. SOLENOID INTERLOCKS

AZM 161 – ACCESSORIES



Centering device	Tamperproof screws	MS AZM 161 ...
 <ul style="list-style-type: none"> ■ Centering device for pre-positioning ■ Mounting outside: TFA-020 101172607 ■ Mounting inside: TFI-020 101172609 	 <ul style="list-style-type: none"> ■ Tamperproof screws with unidirectional slots ■ M5 x 12 101135338 ■ M5 x 16 101135339 ■ M5 x 20 101135340 ■ Quantity 2 pcs 	 <ul style="list-style-type: none"> ■ Mounting set only in combination with B6 ■ Mounting parallel to safety guard: MS AZM 161 P 101150376 ■ Mounting right-angled to safety guard: MS AZM 161 R/P 101149213
Slot sealing plug AZM 161	Triangular key M5	
 <ul style="list-style-type: none"> ■ To cover unused actuator slots ■ For protection against the ingress of dirt ■ Easy to install by just clipping in 	 <ul style="list-style-type: none"> ■ For manual release 	

2. SOLENOID INTERLOCKS

AZM 170 – ACTUATOR SELECTION



Actuator type	Actuator description	Designed for					Type designation	Material number
			R _{min} [mm]	d [mm]	R _{min} [mm]	d [mm]		
Flexible actuator	AZM 170 standard		50	11	50	11	AZM 170-B6	101123391
	For left-hand side door hinge with individual coding		50	11	50	11	AZM 170i-B6L	Included in delivery
	For right-hand side door hinge with individual coding		50	11	50	11	AZM 170i-B6R	Included in delivery
Straight actuator	Included in standard version		---	---	---	---	AZ 17/170-B1	101122893
	With rubber mountings		---	---	---	---	AZ 17/170-B1-2245	101137406
	Angled		---	---	---	---	AZ 17/170-B5	101122895
	Longer		---	---	---	---	AZ 17/170-B11	101139788
	Longer and angled		---	---	---	---	AZ 17/170-B15	101139789

Actuating radii

The axis of the hinge must be d [mm] above and in a parallel plane to the top surface of the safety switch. The basis setting provides a minimum radius of R_{min} [mm].

Key



Actuating radius over the small edge of the actuator

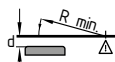

Actuating radius over the wide edge of the actuator



Sliding and removable safety guards



Hinged safety guards

Actuators must be ordered separately.

2. SOLENOID INTERLOCKS

AZ 170 – ACTUATORS AND ACCESSORIES









AZ 17/170-B1 *	101122893	AZ 17/170-B1-2245	101137406	AZ 17/170-B5 *	101122895
 <ul style="list-style-type: none"> ■ Straight actuator ■ Also with individual coding * 	 <ul style="list-style-type: none"> ■ Actuator with rubber mounting ■ Standard coding 	 <ul style="list-style-type: none"> ■ Angled actuator ■ Also with individual coding * 			
AZ 17/170-B11	101139788	AZ 17/170-B15	101139789	AZM 170-B6	101123391
 <ul style="list-style-type: none"> ■ Long straight actuator ■ Standard coding 	 <ul style="list-style-type: none"> ■ Long angled actuator ■ Standard coding 	 <ul style="list-style-type: none"> ■ Flexible actuator ■ Standard coding 			
B6R *	B6L *				
 <ul style="list-style-type: none"> ■ Flexible actuator for right-hand side door hinge ■ Individual coding * 	 <ul style="list-style-type: none"> ■ Flexible actuator for left-hand side door hinge ■ Individual coding * 				

* The actuators with individual coding cannot be delivered individually.

2. SOLENOID INTERLOCKS

AZM 170 – ACTUATORS AND ACCESSORIES

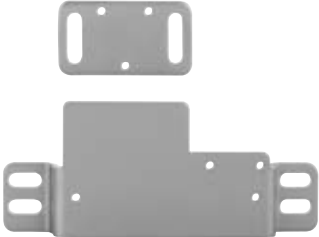

AZM 170-B25-R-G1 101175200	AZM 170-B25-R-G2 101175226	MP AZ 17/170-B25 101175190
 <ul style="list-style-type: none"> ■ Door-handle actuator with star grip ■ For door hinge on the right-hand side 	 <ul style="list-style-type: none"> ■ Door-handle actuator with T-grip ■ For door hinge on the right-hand side 	 <ul style="list-style-type: none"> ■ Mounting plate ■ Accessories only for door-handle actuator AZM 170-B25-..
Centering device	Tamperproof screws	AZM 170-B 101208493
 <ul style="list-style-type: none"> ■ Centering device for pre-positioning ■ Mounting outside: TFA-020 101172607 ■ Mounting inside: TFI-020 101172609 	 <ul style="list-style-type: none"> ■ Tamperproof screws with unidirectional slots M4 x 8 101147463 ■ Quantity 2 pcs 	 <ul style="list-style-type: none"> ■ Centering guide ■ Only in combination with long actuator
MS AZM 170 ...		
 <ul style="list-style-type: none"> ■ Mounting set only in combination with B6 ■ Mounting parallel to safety guard: MS AZM 170 P 101150367 ■ Mounting right-angled to safety guard: MS AZM 170 R/P 101149211 		

2. SOLENOID INTERLOCKS

AZM 190 – ACTUATOR SELECTION



Actuator type	Actuator description	Designed for					Type designation	Material number
			R _{min} [mm]	d [mm]	R _{min} [mm]	d [mm]		
Flexible actuator	Standard 2x15		350	20	650	20	AZM190-B3/2x15	131029938
	Standard 1x7.5		250	20	---	---	AZM190-B3/1x7,5	131029968
	Standard 1x15		200	20	---	---	AZM190-B3/1x15	131029967
Straight actuator	Included in standard version to front mounting		---	---	---	---	AZM190-B1	131029965
			---	---	---	---	AZM190-B5	131029966

Actuating radii

The axis of the hinge must be d [mm] above and in a parallel plane to the top surface of the safety switch. The basis setting provides a minimum radius of R_{min} [mm].

Key







- Actuating radius over the small edge of the actuator
- Actuating radius over the wide edge of the actuator
- Sliding and removable safety guards
- Hinged safety guards

Actuators must be ordered separately.

2. SOLENOID INTERLOCKS

AZM 190 – ACTUATORS AND ACCESSORIES



AZM190-B1 131029965	AZM190-B5 131029966	AZM190-B3/2x15 131029938
 <ul style="list-style-type: none"> ■ Straight actuator ■ Compensation for tolerances by means of rubber buffers 	 <ul style="list-style-type: none"> ■ Actuator to front mounting ■ Particularly suitable for front mounting and hinged protective equipment 	 <ul style="list-style-type: none"> ■ Flexible actuator ■ For very small actuating radius over the small and wide edge of the actuator
AZM190-B3/1x7.5 131029968	AZM190-B3/1x15 131029967	MP190 131029969
 <ul style="list-style-type: none"> ■ Flexible actuator 	 <ul style="list-style-type: none"> ■ Flexible actuator 	 <ul style="list-style-type: none"> ■ Mounting plate ■ For simple mounting of an AZM 190 on profile systems
MP190-V 133009486	ZPG190 101029970	Triangular key TZ-75 101028565
 <ul style="list-style-type: none"> ■ Mounting plate ■ Internal mounting of the interlock and mounting plate with door hinge on right-hand side ■ with left-hinged door <p>MP190-VD 133009487</p>	 <ul style="list-style-type: none"> ■ Axial cable entry 	 <ul style="list-style-type: none"> ■ Angled triangular key ■ For manual release ■ The straight triangular key TZ-69 is included in delivery

2. SOLENOID INTERLOCKS

AZM 415 – ACTUATOR SELECTION



Actuator type	Actuator description	Designed for					Type designation	Material number
			R _{min} [mm]	d [mm]	R _{min} [mm]	d [mm]		
Flexible actuator	For very small actuating radius over the wide edge of the actuator		---	---	250	36	AZ/AZM 415-B2	101144796
	For very small actuating radius over the small edge of the actuator		250	36	---	---	AZ/AZM 415-B3	101144797
Straight actuator	For sliding safety guards		---	---	---	---	AZ/AZM 415-B1	101128545

Actuating radii

The axis of the hinge must be d [mm] above and in a parallel plane to the top surface of the safety switch. The basis setting provides a minimum radius of R_{min} [mm].

Key





- Actuating radius over the small edge of the actuator
- Actuating radius over the wide edge of the actuator
- Sliding and removable safety guards
- Hinged safety guards

Actuators must be ordered separately.

2. SOLENOID INTERLOCKS

AZM 415 – ACTUATORS AND ACCESSORIES



AZ/AZM 415-B1	101128545	AZ/AZM 415-B2	101144796	AZ/AZM 415-B3	101144797
 <ul style="list-style-type: none"> ■ Straight actuator ■ For sliding safety guards 	 <ul style="list-style-type: none"> ■ Flexible actuator ■ Particularly suitable for hinged safety guards ■ For very small actuating radius over the wide edge of the actuator 	 <ul style="list-style-type: none"> ■ Flexible actuator ■ Particularly suitable for hinged safety guards ■ For very small actuating radius over the small edge of the actuator 			
AZ/AZM 415-B4PS	101142540	Triangular key M5	101100887		
 <ul style="list-style-type: none"> ■ For sliding safety guards ■ With locking bolt and ball latch 	 <ul style="list-style-type: none"> ■ For manual release 				

2. SOLENOID INTERLOCKS

AZM 40 – ACTUATORS AND ACCESSORIES



AZM40-B1	103034199	AZM40-B1-PH	103037328	Centering device
 <ul style="list-style-type: none"> ■ Smooth adjustment ■ Versatile mounting due to 180° angular flexibility of the actuator 	 <ul style="list-style-type: none"> ■ Smooth adjustment ■ Versatile mounting due to 180° angular flexibility of the actuator ■ Flat enclosure for protruding screws 	 <ul style="list-style-type: none"> ■ Centering device for pre-positioning ■ Mounting outside: TFA-020 101172607 ■ Mounting inside: TFI-020 101172609 		
ACC-NRS-M5X30-CSS-2PCS	103040845	ACC-NRS-M5X29-FHS-2PCS	103040844	
 <ul style="list-style-type: none"> ■ M5 Counter sunk screw with unidirectional slots 	 <ul style="list-style-type: none"> ■ M5 Flat headed screw with unidirectional slots 			

Actuators must be ordered separately.

UP-TO-DATE WITHOUT FAIL THE SCHMERSAL WEBSHOP

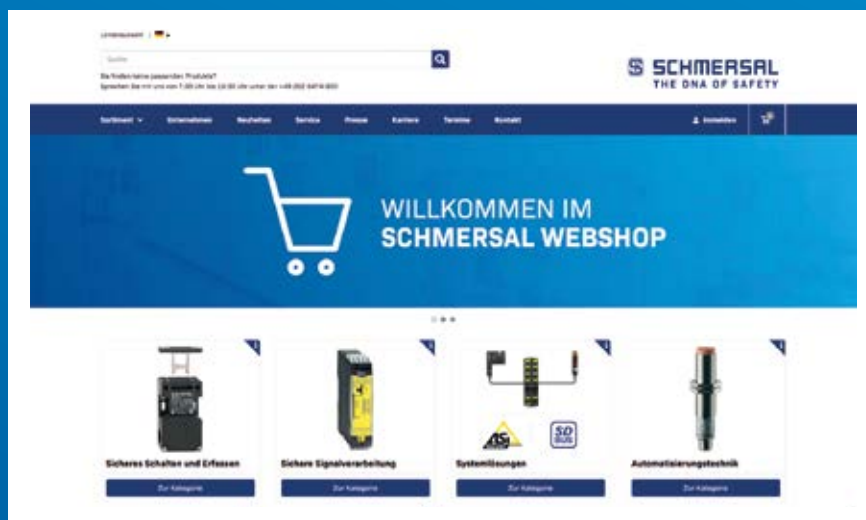

FOR DETAILED INFORMATION, CHECK OUT
[PRODUCTS.SCHMERSAL.COM](https://products.schmersal.com)

2. SOLENOID INTERLOCKS

AZM 201 – ACTUATOR SELECTION



Series	Door hinge		Emergency exit				Type	Material number
	Left	Right	P0					
AZ/AZM 201-B1	■						AZ/AZM201-B1-LT	103013493
			■				AZ/AZM201-B1-LTP0	103013496
		■					AZ/AZM201-B1-RT	103013494
			■				AZ/AZM201-B1-RTP0	103013495

Series	Door hinge		Mounted		Door handle		Rotating knob		Emergency exit				Locking rod	Lockout tag	Type	Material number						
	Left	Right	Inside	Outside	G1	G2	without	Included in standard version	Metal film	Metal film	P30/P31											
								P1	P20	P25												
AZ/AZM 201-B30	■		■		■			■							AZ/AZM201-B30-LTIG1P1	103025197						
							■										AZ/AZM201-B30-LTAG1	103013501				
								■												AZ/AZM201-B30-LTAG1P1	103013498	
								■										■			AZ/AZM201-B30-LTAG1P1-SZ	103013500
															■						AZ/AZM201-B30-LTAG1P20	103027215
																■			■		AZ/AZM201-B30-LTAG1P20-SZ	103026322
																	■				AZ/AZM201-B30-LTAG1P25	103028172
																		■			AZ/AZM201-B30-LTAG1P30	103015820
																		■			AZ/AZM201-B30-LTAG1P31	103015821
																		■	■		AZ/AZM201-B30-LTAG1P31-SZ	103015822
							■								AZ/AZM201-B30-LTAG2	103030662						
								■							AZ/AZM201-B30-LTAG2P1	103025248						
		■		■		■			■							AZ/AZM201-B30-RTIG1P1	103025195					
	■																			AZ/AZM201-B30-RTAG1	103013502	
								■													AZ/AZM201-B30-RTAG1P1	103013497
								■											■		AZ/AZM201-B30-RTAG1P1-SZ	103013499
																■			■		AZ/AZM201-B30-RTAG1P20-SZ	103026321
																	■				AZ/AZM201-B30-RTAG1P25	103028173
																		■			AZ/AZM201-B30-RTAG1P30	103015823
																		■			AZ/AZM201-B30-RTAG1P31	103015824
																	■	■		AZ/AZM201-B30-RTAG1P31-SZ	103015825	
												■		■						AZ/AZM201-B30-RTAG2P1	103025247	

Actuators must be ordered separately. Further actuator versions AZ/AZM201-B30 are available on request.

2. SOLENOID INTERLOCKS

AZM 201 – ACTUATORS AND ACCESSORIES



AZ/AZM201-B1-...	AZ/AZM201-B1-...-P0	AZ/AZM201-B30-...-P30/P31
 <ul style="list-style-type: none"> ■ Actuator for sliding safety guards ■ Left-hand side actuating direction AZ/AZM201-B1-LT 103013493 ■ Right-hand side actuating direction AZ/AZM201-B1-RT 103013494 	 <ul style="list-style-type: none"> ■ With emergency exit P0 ■ Left-hand side actuating direction AZ/AZM201-B1-LTP0 103013496 ■ Right-hand side actuating direction AZ/AZM201-B1-RTP0 103013495 	 <ul style="list-style-type: none"> ■ Three point locking linkage for requirements with increased mechanical stability (7,000 N)
AZ/AZM201-B30-...-G1	AZ/AZM201-B30-...-SZ	AZ/AZM201-B30-...-G2
 <ul style="list-style-type: none"> ■ Actuator for hinged safety guards 	 <ul style="list-style-type: none"> ■ Actuator B30 with lockout tag 	 <ul style="list-style-type: none"> ■ Actuator with rotating knob
AZ/AZM201-...-P1	AZ/AZM201-...-P20	AZ/AZM201-...-P25
 <ul style="list-style-type: none"> ■ Emergency exit 	 <ul style="list-style-type: none"> ■ Emergency exit (metal) 	 <ul style="list-style-type: none"> ■ Emergency exit (metal)

The actuation system selection can be found at products.schmersal.com.

2. SOLENOID INTERLOCKS

AZM 201 AND AZM 300 – ACTUATORS AND ACCESSORIES



SZ 200-1	101196397	SZ 200	101194438	RF-AZM200-T/-N
 <ul style="list-style-type: none"> ■ Lockout tag with 6 bore holes for AZM 201 and AZM 300 ■ To prevent inadvertent closing, e.g. during maintenance 	 <ul style="list-style-type: none"> ■ Lockout tag with 5 bore holes for AZM 201 ■ To prevent inadvertent closing, e.g. during maintenance 	 <ul style="list-style-type: none"> ■ Emergency exit as retrofit kit RF-AZM200-T 103004966 ■ Emergency release as retrofit kit RF-AZM200-N 103003543 		
AZ/AZM300-B1	101218025	MP-AZ/AZM300-1	103003172	MS-AZ/AZM300-B1-1 103002891
 <ul style="list-style-type: none"> ■ Actuator ■ 3 different directions of actuation 	 <ul style="list-style-type: none"> ■ Mounting plate 	 <ul style="list-style-type: none"> ■ Aluminium protective plate as a cover ■ Threaded heads made of aluminium with M6 thread incl. rubber discs 		
AZM300-...-T / -N	ACC-AZM300-BOW	103028145	ACC-AZM-BOW-H-1-RD 103027454	
 <ul style="list-style-type: none"> ■ Emergency exit (-T) for fitting and actuation only from within the hazardous area ■ Emergency release (-N) for fitting and actuation only on the outside of the safety guard 	 <ul style="list-style-type: none"> ■ Remote release ■ Unlocking via wire rope ■ Can also be used as emergency exit or emergency release 	 <ul style="list-style-type: none"> ■ T-grip for Bowden cable release ACC-AZM300-BOW or ACC-AZM400-BOW 		

Actuators must be ordered separately.

2. SOLENOID INTERLOCKS

AZM 400 AND MZM 100 – ACTUATORS AND ACCESSORIES



AZM400-B1	103003508	MS-AZM400	103009179	SZ400	103015742
 <ul style="list-style-type: none"> ■ Actuator 	 <ul style="list-style-type: none"> ■ Mounting set for AZM 400 and actuator ■ For simple installation on 40 mm aluminium profiles 	 <ul style="list-style-type: none"> ■ Lockout tag with 6 bore holes for AZM 400 ■ To prevent inadvertent closing, e.g. during maintenance 			
ACC-AZM400-BOW-4M/6M	103015308	ACC-AZM-BOW-H-1-RD	103027454		
 <ul style="list-style-type: none"> ■ Remote release ■ Unlocking via wire rope ■ Can also be used as emergency exit or emergency release ■ Only in combination with basic components AZM400...BOW 	 <ul style="list-style-type: none"> ■ T-grip for Bowden cable release ACC-AZM300-BOW or ACC-AZM400-BOW 				
MZM 100-B1.1	101204290	MS MZM 100-W	101185510	MZM 100 TARGET	101210642
 <ul style="list-style-type: none"> ■ Actuator free from play for MZM 100 ■ Neutralisation of undesired noises 	 <ul style="list-style-type: none"> ■ Mounting set for MZM 100 ■ Screws are included in delivery 	 <ul style="list-style-type: none"> ■ For MZM 100 ■ For the variable setting of the latching force ■ Gradually adjustable by steps of approx. 10 N within a range from approx. 30 N to 100 N 			

Actuators must be ordered separately.

3. KEY TRAPPED SYSTEMS DESCRIPTION

AREA OF APPLICATION

The SHGV key transfer system occurs mainly in more complex manufacturing systems and equipment. It is especially suitable for the protection of distributed maintenance and service doors that are rarely used. Further areas of application are installations installed in harsh Ambient conditions and in areas with high ambient temperatures, not forgetting the potentially explosive installations in the chemical and process engineering industries.

COST SAVINGS

Saving costs with movable protection equipment, without affecting the safety level is possible with the safety door monitoring system SHGV. The cost saving is achieved because no wiring is needed between the moving protection equipment and switching cabinet.

Instead, the operation of the electrical locking is taken on by an intelligent key transfer between a switching element with lock mounted on the protection equipment and a key-selector-switch as control element mounted on the control panel.

DESIGN AND WAY OF FUNCTIONING

With the SHGV-system, the key contains the information as to whether the protection door or maintenance flap can be opened or not. In the initial state, all the keys used are each in a key-selector-switch that is mostly located in a central console, and from there releases functions of the machine control. The key can only be removed from there when the machine is in the safe operating mode. The operator can then use the key by inserting it into the lock barrel of the protection equipment and open the safety door. The key can only be removed when the safety door is closed and locked again. The machine or the hazardous movement can be started again once the key is back in the selector-switch. If the transfer time between making a selection with the key-selector-switch (removal of the key) and the unlocking of the protection equipment is insufficient, until a hazardous machine motion has come to a stop, then an additional key-selector-switch latch unit (SVE) may be required. The SHGV series also has a version with a second lock barrel which blocks the actuation of the first lock barrel, if an operator needs to enter a space and needs protection against the machine being started unintentionally by third parties.

The special features of this safety and interlock system is that safety doors do not have any electrical supply, nor do they require any signal cable. The information as to whether a safety door can be opened or a machine may be set in motion is transmitted with the key. This creates additional freedom and facilitates the mounting of interlock systems in particular for larger installations.

Information for the selection of suitable safety relay modules can be found in the chapter "Safety relay modules" (refer to page 220).

FUNCTIONAL SEQUENCE

The automatic mode of the machine control is released, if the NC contact(s) of a 2-digit key-selector-switch is/are closed. This corresponds to the position of the key-selector-switch, in which the key is in a non-removable position.

1. To interrupt or shut-down the automatic mode, the key in the key-selector-switch is switched from the non-removal position to the removal position. The NC contacts are forced open and the automatic operating mode of the machine control system is forcibly interrupted.

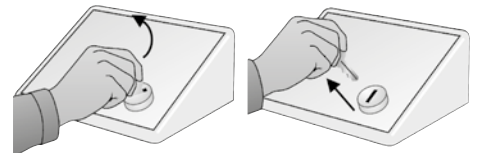

2. This allows the transfer of the key from key-selector-switch to the movable protection equipment.



3. The unlocking of the interlock of the protection equipment is done by turning the lock barrel to the non-removal position.

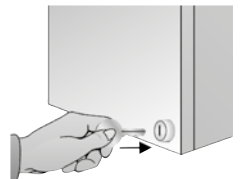

4. The protection equipment can be opened.

5. The return of the key (if the protective equipment is opened) is blocked by an incorrect locking protection mechanism.

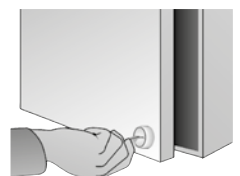

6. If the protection equipment is closed again, the blocking of the protection equipment is carried out by turning the key from the non-removal position to the removal position.

7. The return of the key to the key-selector-switch is used to switch the machine control system on again, by moving from the removal position to the non-removal position.

3. KEY TRAPPED SYSTEMS APPLICATION

SYSTEM-CONFIGURATIONS

Hazardous run-on time < Time for the key transfer

One key-selector-switch SHGV/ESS locks one moveable piece of protection equipment

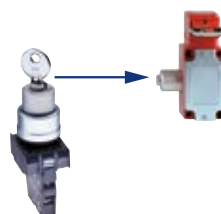

One key-selector-switch SHGV/ESS locks several moveable pieces of protection equipment using the key-distribution-station SVM

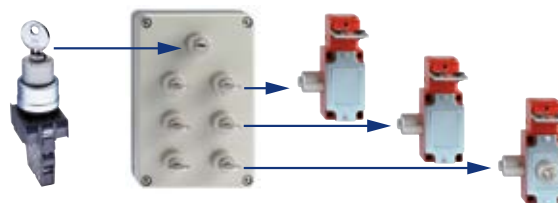

Hazardous run-on time > Time for the key transfer

A SVE key-selector-switch interlocking device locks up to 3 moveable pieces of protection equipment depending on the run-on movements

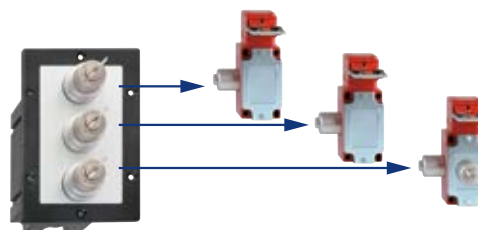

A SVE key-selector-switch interlocking device locks several moveable pieces of protection equipment using the SVM key-distribution-station depending on the run-on movements

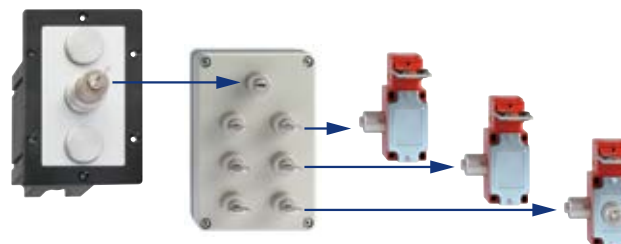

3. KEY TRAPPED SYSTEMS OVERVIEW

OVERVIEW

Components of the trapped key system		you can find from
SHGV	Guard Locking Device	Page 68
	Actuator	Page 71
SVM	Key Distribution Station	Page 72
SHGV/ESS21	Key Selector Switch	Page 76
SVE	Solenoid interlock with key-operated selector switch	Page 78
	Accessories	Page 82

3. KEY TRAPPED SYSTEMS

GUARD LOCKING DEVICE SHGV – OVERVIEW OF THE SERIES



■ SHGV/B01/...



■ SHGV/L01/...



■ SHGV/R01/...

Key Features

- Lock barrel at the bottom
- With one actuating head
- Actuator head can be rotated in 90° steps

- Lock barrel to left
- With one actuating head
- Actuator head can be rotated in 90° steps

- Lock barrel to the right
- With one actuating head
- Actuator head can be rotated in 90° steps

Other versions

ATEX



Technical features

Mechanical data

Material of the enclosure

Aluminium

Aluminium

Aluminium

Latching force

5 N

5 N

5 N

Holding force F_{max}

1,750 N

1,250 N

1,250 N

Holding force F_{zh}

1,300 N

950 N

950 N

Dimensions (W x D x H)

40 x 87 x 103 mm

87 x 43 x 103 mm

87 x 43 x 103 mm

Ambient conditions

Ambient temperature

-25 °C ... +70 °C

-25 °C ... +70 °C

-25 °C ... +70 °C

Degree of protection

IP65

IP65

IP65

Safety classification

Standards

EN ISO 13849-1

EN ISO 13849-1

EN ISO 13849-1

B_{100} NC contact

100,000

100,000

100,000

Certificates

-

-

-



To get detailed information about the products and certificates, visit products.schmersal.com.



■ SHGV/LD1/...



■ SHGV/RD1/...



■ SHGV/B1.1/...



■ SHGV/L1.1/...



■ SHGV/R1.1/...

- Lock barrel left and secondary key on the front
- With one actuating head
- Actuator head can be rotated in 90° steps

- Lock barrel right and secondary key on the front
- With one actuating head
- Actuator head can be rotated in 90° steps

- Lock barrel at the bottom
- With two actuating heads
- Actuator head can be rotated in 90° steps

- Lock barrel to left
- With two actuating heads
- Actuator head can be rotated in 90° steps

- Lock barrel to the right
- With two actuating heads
- Actuator head can be rotated in 90° steps



Aluminium	Aluminium	Aluminium	Aluminium	Aluminium
5 N	5 N	5 N	5 N	5 N
1,250 N	1,250 N	1,750 N	1,250 N	1,250 N
950 N	950 N	1,300 N	950 N	950 N
87 x 87 x 103 mm	87 x 87 x 103 mm	40 x 87 x 135 mm	87 x 43 x 135 mm	87 x 43 x 135 mm
-25 °C ... +70 °C	-25 °C ... +70 °C	-25 °C ... +70 °C	-25 °C ... +70 °C	-25 °C ... +70 °C
IP65	IP65	IP65	IP65	IP65
EN ISO 13849-1	EN ISO 13849-1	EN ISO 13849-1	EN ISO 13849-1	EN ISO 13849-1
100,000	100,000	100,000	100,000	100,000
-	-	-	-	-

3. KEY TRAPPED SYSTEMS

GUARD LOCKING DEVICE SHGV – PREFERRED TYPES



Range	Lock barrel position			Number of safety guards	Type designation
	Bottom-side	Left	Right		
SHGV/B01/...	■			1	SHGV/B01/x1x+x3x
SHGV/L01/...		■		1	SHGV/L01/x1x+x3x
SHGV/R01/...			■	1	SHGV/R01/x1x+x3x
SHGV/LD1/.../...		■		1	SHGV/LD1/x1x/x2x+x3x
SHGV/RD1/.../...			■	1	SHGV/RD1/x1x/x2x+x3x
SHGV/B1.1/...	■			2	SHGV/B1.1/x1x+x3x
SHGV/L1.1/...		■		2	SHGV/L1.1/x1x+x3x
SHGV/R1.1/...			■	2	SHGV/R1.1/x1x+x3x

Ordering example:

SHGV-Z/RD1/101/35+BO

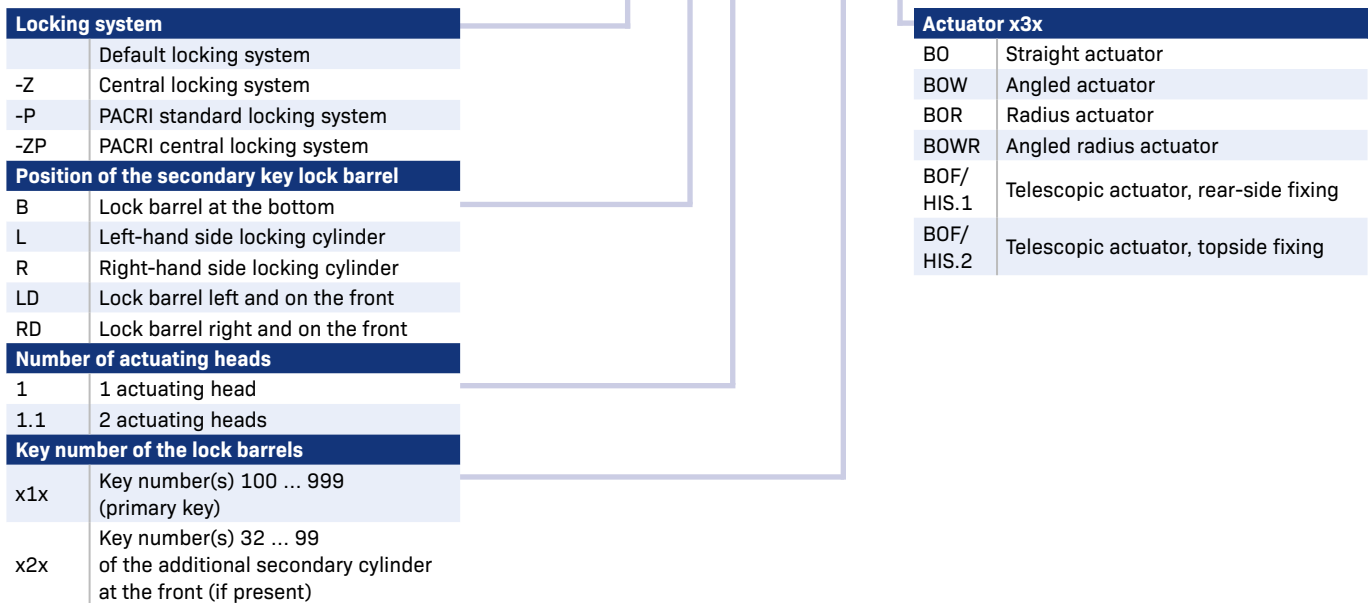

For technical reasons not all possible variations and key combinations can be delivered. The existing key type is used to translate the product type designation.

To see a wide range of other types, visit products.schmersal.com.

3. KEY TRAPPED SYSTEMS

GUARD LOCKING DEVICE SHGV – ACTUATOR



BO	101014460	BOW	101014462	BOR	101014461
 <ul style="list-style-type: none"> ■ Straight actuator ■ Actuating radius R_{min}: 400 mm 	 <ul style="list-style-type: none"> ■ Straight actuator ■ Angled ■ To front mounting ■ Actuating radius R_{min}: 400 mm 	 <ul style="list-style-type: none"> ■ Radius actuator ■ Actuating radius R_{min}: 350 mm 			
BOWR	101014463	BOF/HIS.1	101025450	BOF/HIS.2	101025451
 <ul style="list-style-type: none"> ■ Radius actuator ■ Angled ■ To front mounting ■ Actuating radius R_{min}: 350 mm 	 <ul style="list-style-type: none"> ■ Telescopic actuator ■ Flexible ■ Rear-side fixing ■ Actuating radius R_{min}: 400 mm 	 <ul style="list-style-type: none"> ■ Telescopic actuator ■ Flexible ■ Topside fixing ■ Actuating radius R_{min}: 400 mm 			

The actuator is included in the delivery of the SHGV interlocking system.

Detailed information regarding the actuator selection and other actuators can be found at products.schmersal.com.

3. KEY TRAPPED SYSTEMS

KEY DISTRIBUTION STATION SVM – SERIES SUMMARY



■ SVM1/...-6/.../A



■ SVM1/...-10/.../A

Key Features

- Enclosure for surface mounting
- A primary lock barrel
- For 6 keys

- Enclosure for surface mounting
- A primary lock barrel
- For 10 keys

Other versions

ATEX



Technical features

Mechanical data

Housing material / mounting plate

Aluminium

Aluminium

Dimensions (H x W x D)

120 x 113.5 x 180 mm

120 x 113.5 x 240 mm

Ambient conditions

Ambient temperature

-25 °C ... +50 °C

-25 °C ... +50 °C

Degree of protection

IP65

IP65

Safety classification

Standards

EN ISO 13849-1

EN ISO 13849-1

B₁₀₀ NC contact

100,000

100,000

Certificates

-

-



To get detailed information about the products and certificates, visit products.schmersal.com.



■ SVM1/...-6/.../E

■ SVM1/...-10/.../E

- Mounting plate pre-mounted
- A primary lock barrel
- For 6 keys

- Mounting plate pre-mounted
- A primary lock barrel
- For 10 keys



Stainless steel	Stainless steel
120 x 52.5 x 180 mm	120 x 54.5 x 240 mm
-25 °C ... +50 °C	-25 °C ... +50 °C
IP65	IP65

EN ISO 13849-1	EN ISO 13849-1
100,000	100,000
-	-

3. KEY TRAPPED SYSTEMS

KEY DISTRIBUTION STATION SVM – PREFERRED TYPES



Range	Assembly housing	Assembly plate	Primary lock barrel	Number of lock barrels	Coloured key-shaft	Type designation
SVM1/...-6/.../A	■		1	6		SVM1/x1x-6/x2x/A
SVM1/...-10/.../A	■		1	10		SVM1/x1x-10/x2x/A
SVM1/...-6/.../E		■	1	6		SVM1/x1x-6/x2x/E
SVM1/...-10/.../E		■	1	10		SVM1/x1x-10/x2x/E

Ordering example:

SVM1-Z/35-6/115/A



For technical reasons not all possible variations and key combinations can be delivered. The existing key type is used to translate the product type designation.

To see a wide range of other types, visit products.schmersal.com.

**UP-TO-DATE WITHOUT FAIL
ONLINE ON THE WORLD WIDE WEB**



**FOR DETAILED INFORMATION, CHECK OUT
WWW.SCHMERSAL.COM**

3. KEY TRAPPED SYSTEMS

KEY-SELECTOR-SWITCH SHGV/ESS21 – SERIES SUMMARY



■ SHGV/ESS21S2/.../103

Key Features

- Variable key numbers
- Removal position in position 1
- 1 NC contact / 1 NO contact

Other versions

ATEX



Technical features

Electrical data

Max. switching capacity U/I 230 VAC / 8 A;
24 VDC / 5 A

Termination Screw connection

Cable section

Solid wire 2x 0.5 ... 2.5 mm²

Stranded wire with conductor ferrules 2x 0.5 ... 1.5 mm²

Mechanical data

Material of the front-ring Aluminium

Material of the lock barrel Steel

Mounting hole 22.3 mm

Front ring diameter 29.5 mm

Installation height with key 62 mm

Front plate thickness 1 ... 6 mm

Switch position 2

Ambient conditions

Ambient temperature 0 °C ... +75 °C

Degree of protection IP65 (key-operated switch)

Safety classification

Standards EN ISO 13849-1

B_{10D} NC contact 100,000

Certificates cULus



To get detailed information about the products and certificates, visit products.schmersal.com.

3. KEY TRAPPED SYSTEMS

SHGV/ESS21 – PREFERRED TYPES



Series	NC contacts	NO contacts	Removal position	Number of keys	Coloured key-shaft	Type designation
SHGV/ESS21S2/.../103	1	1	1	2		SHGV/ESS21S2/xxx/103

Ordering example:

SHGV-Z/ESS21S2/101/103



For technical reasons not all possible variations and key combinations can be delivered. The existing key type is used to translate the product type designation.

To see a wide range of other types, visit products.schmersal.com.

3. KEY TRAPPED SYSTEMS

SOLENOID INTERLOCK WITH KEY-OPERATED SELECTOR SWITCH SVE



■ SVE1/...

■ SVE2/...

Key Features

- Installation housing
- One lock barrel
- Manual release
- Up to 5 contacts

- Installation housing
- Two lock barrels
- Manual release
- Screw terminals
- Up to 6 contacts

Other versions

ATEX



Technical features

Electrical data		
Operating voltage	230 VAC / 115 VAC / 24 VDC	230 VAC / 115 VAC / 24 VDC
Operating current	0.35 A	0.35 A
Max. switching capacity U/I	230 VAC / 4 A; 24 VDC / 4 A	230 VAC / 4 A; 24 VDC / 4 A
Termination	Screw terminals	Screw connection
Cable section		
Solid wire	2x 0.25 ... 2.5 mm ²	2x 0.25 ... 2.5 mm ²
Stranded wire with conductor ferrules	2x 0.25 ... 2.5 mm ²	2x 0.25 ... 2.5 mm ²
Mechanical data		
Material of the enclosure	Plastic	Plastic
Material of the mounting plate	Aluminium	Aluminium
Material of the lock barrel	Steel	Steel
Dimensions (H x W x D)	96 x 169 x 144 mm	96 x 169 x 144 mm
Ambient conditions		
Ambient temperature	0 °C ... +50 °C	0 °C ... +50 °C
Degree of protection	IP65	IP65

Safety classification

Standards	EN ISO 13849-1	EN ISO 13849-1
B ₁₀₀ NC contact	100,000	100,000
Certificates	-	-



To get detailed information about the products and certificates, visit products.schmersal.com.



■ SVE3/...

- Installation housing
- Three lock barrels
- Manual release
- Up to 8 contacts



230 VAC / 115 VAC / 24 VDC

0.35 A

230 VAC / 4 A;
24 VDC / 4 A

Screw terminals

2x 0.25 ... 2.5 mm²

2x 0.25 ... 2.5 mm²

Plastic

Aluminium

Steel

96 x 169 x 144 mm

0 °C ... +50 °C

IP65

EN ISO 13849-1

100,000

-

3. KEY TRAPPED SYSTEMS

SVE – PREFERRED TYPES



Range	Lock barrel	Lock barrel position			Coloured key-shaft	Safety contacts			Auxiliary contacts	Operating voltage	Type designation
		Left	Centered	Right		Included in standard version	-3NC	- W			
SVE1/...	1		■			2	3	2	2	24 VDC	SVE1/xxx-24VDC
										24 VAC	SVE1/xxx-24VAC
										115 VAC	SVE1/xxx-115VAC
										230 VAC	SVE1/xxx-230VAC
SVE2/...	2	■		■		2	3	3	3	24 VDC	SVE2/xxx-24VDC
										24 VAC	SVE2/xxx-24VAC
										115 VAC	SVE2/xxx-115VAC
										230 VAC	SVE2/xxx-230VAC
SVE3/...	3	■	■	■		2	3	4	4	24 VDC	SVE3/xxx-24VDC
										24 VAC	SVE3/xxx-24VAC
										115 VAC	SVE3/xxx-115VAC
										230 VAC	SVE3/xxx-230VAC

Standard safety contacts	Safety contacts -3Ö	Safety contacts -W
<p> ■ Safety contacts: Magnet: 1 NC/1 NO contact; Key-operated selector switch: 1 NC /1 NO contact; NC contacts in series </p>	<p> ■ Safety contacts: Magnet: 1 NC/1 NO contact; Key-operated selector switch: 2 NC /1 NO contact; NC contacts in series </p>	<p> ■ Safety contacts: Magnet: 1 NC/1 NO contact; Key-operated selector switch: 1 NC /1 NO contact; NC contacts separately </p>

To see a wide range of other types, visit products.schmersal.com.

3. KEY TRAPPED SYSTEMS

SVE – ORDERING CODE



Ordering example:

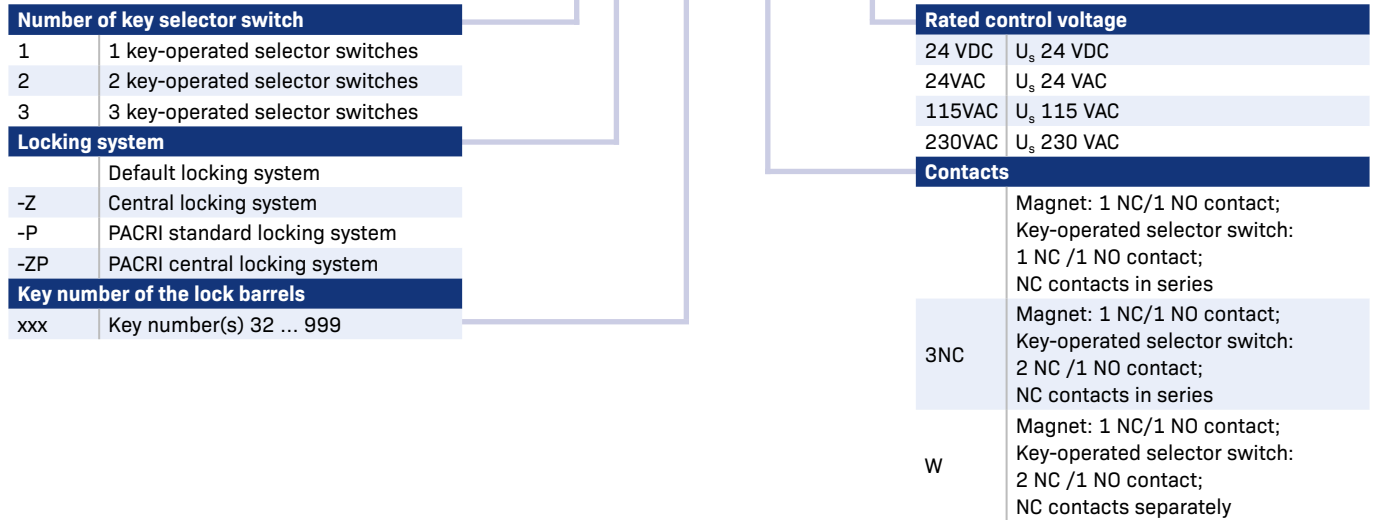

SVE1-Z/101-3Ö-24VAC



For technical reasons not all possible variations and key combinations can be delivered. The existing key type is used to translate the product type designation.

To see a wide range of other types, visit products.schmersal.com.

3. KEY TRAPPED SYSTEMS ACCESSORIES

Contact element EF 103.2	101006548	Contact element EF 103.3	101006549	SHGV-SK	101183035
 <ul style="list-style-type: none"> ■ 1 NC contact / 1 NO contact ■ Screw terminals ■ Assembly flange position 2 ■ Contact labelling: 31-32; 43-44 		 <ul style="list-style-type: none"> ■ 1 NC contact / 1 NO contact ■ Screw terminals ■ Assembly flange position 3 ■ Contact labelling: 51-52; 63-64 		 <ul style="list-style-type: none"> ■ Dust shield cap 	

Coloured key-shaft	Color	Colour code	Type	Material number
 <ul style="list-style-type: none"> ■ Both key head parts can be glued to the key by means of a commercially available cyanide-acrylate adhesive for technical plastics. ■ Quantity 5 pieces ■ Not in connection with a central locking system! 	blue	BL	SHGV-SR/BL	101160194
	brown	BR	SHGV-SR/BR	101181721
	yellow	GE	SHGV-SR/GE	101160199
	green	GN	SHGV-SR/GN	101160197
	grey	GR	SHGV-SR/GR	101181719
	red	RT	SHGV-SR/RT	101160196
	black	BK	SHGV-SR/SW	101160193
	white	WS	SHGV-SR/WS	101160200

UP-TO-DATE WITHOUT FAIL THE SCHMERSAL WEBSHOP

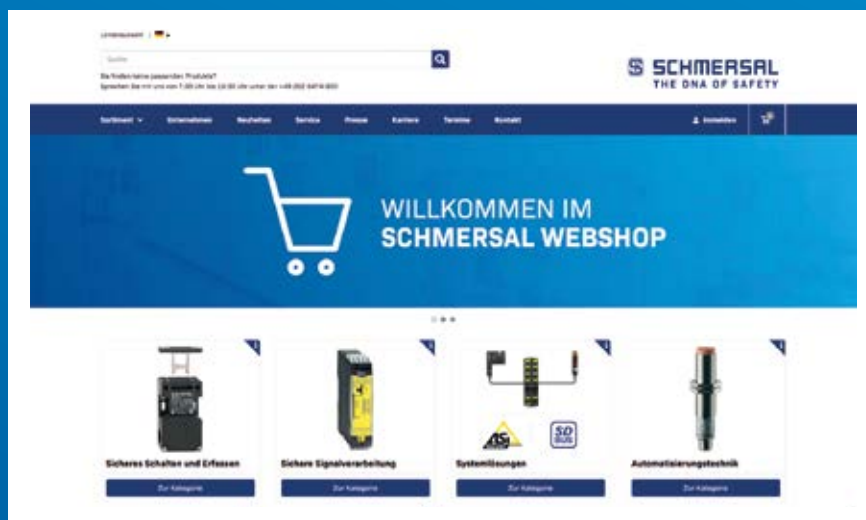

FOR DETAILED INFORMATION, CHECK OUT
[PRODUCTS.SCHMERSAL.COM](https://products.schmersal.com)

4. POSITION SWITCHES DESCRIPTION

SYSTEM UNIVERSALLY DEPLOYABLE SERIES

Recording and monitoring, from extraordinarily compact to very robust.

With these properties, the new position switches are aimed at a wide variety of applications across all disciplines of mechanical engineering and plant manufacturing as well as elevator technology.

The advantages of the new position switch series at a glance:

- Reliable position detection
- Highly versatile
- Robust and reliable
- Can be combined in numerous ways thanks to modular design

AREA OF APPLICATION

Type 1 position switches according to EN ISO 14119 are for determining the position and monitoring of movable components on machines and for protective equipment that can be moved laterally or is rotatable. This allows them to be used in all industrial environments.

The protection classes IP66 an IP67 form the requirements for the use of position switches in adverse ambient conditions.

DESIGN AND WAY OF FUNCTIONING

All position switches are equipped with positive break NC contacts in accordance with EN 60947-5-1 and are available with snap action and also slow action. In conjunction with an appropriate safety controller, a single position switch can be used up to PL d. Using two position switches PL e can be achieved according to EN ISO 13849-1.

FLEXIBLE SOLUTIONS

Switching elements with up to three contacts

Switching elements with three contacts ensures a redundant switch-off with additional signalling contact. All switching elements of the diverse contact combinations are equipped with galvanically separated contacts with positive break NC contacts.

Latching function

To save the switching state, versions are available with snap action and an optional latching function where the mounting element must be manually reset to the starting condition.

Modular diversity

The modular design with consistent components across all series reduces the number of different versions, lowers the effort required for storage and increases availability.



ACTUATOR ELEMENTS AND LEVER

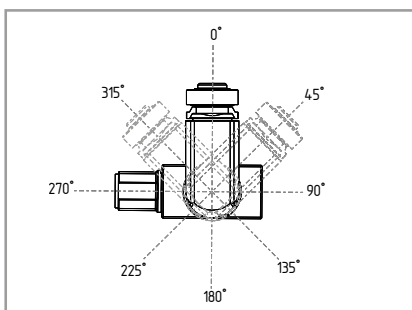

Adjustable actuator elements
All actuating elements can be rotated in 45° increments and can be quickly replaced and implemented due to the simple mounting design.

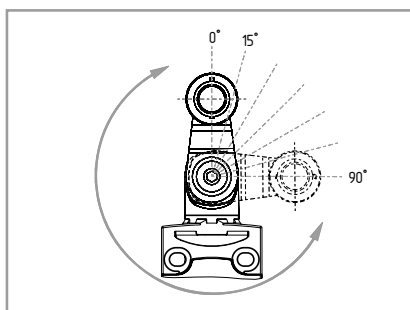

Adjustable lever
Roller lever can be set in 15° steps.

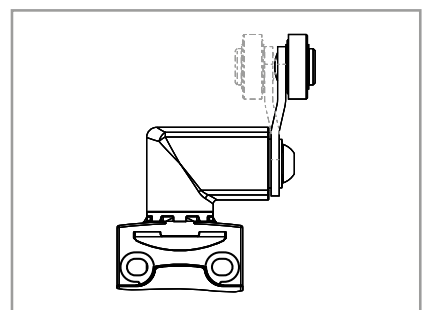

Rotatable lever
For versions with a rotatable roller lever, the lever can be fitted so that the roller is on the inside.

4. POSITION SWITCHES

ORDER INFORMATION COMPLETE DEVICE OR MODULAR CONSTRUCTION KIT

All position switches of the PS116, PS2xx and PS3xx series can be obtained either as a complete device or a modular construction kit. The complete device with actuating element S200 serves as a basic switch in the construction kit system. The following ordering example can therefore be transferred to all of the series listed.

ORDER EXAMPLE

Position switch PS116, snap action 1 NO contact / 1 NC contact, roller lever, M12 connector on right



Complete device



PS116-Z11-STR-H200

Modular selection (construction kit) to be ordered separately



Basic switch:
PS116-Z11-STR-S200



Actuator head:



PS-H200



PS-K240



PS-K250

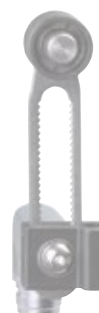

PS-N200



PS-J200

For assembly of the modular selection, the enclosure of the thrust pin included in the basic switch must be removed and replaced by the roller lever PS-H200.

ORDERING CODE

PSXXX-Z11A2-L200-S200

Switching elements (others on request)

T02	Slow action 2 NC contacts
T02H	Slow action 2 NC contacts with staggered contacts
T03	Slow action 3 NC contacts
T10	Slow action 1 NO contact
T11	Slow action 1 NO contact / 1 NC contact
T11UE	Slow action 1 NO contact / 1 NC contact with overlapping contacts
T12	Slow action 1 NO contact / 2 NC contacts
T20	Slow action 2 NO contacts
T21	Slow action 2 NO contacts / 1 NC contact
Z02	Snap action 2 NC contacts
Z11	Snap action 1 NO contact / 1 NC contact
Z11R	Snap action 1 NO contact / 1 NC contact with latching (not for PS3xx)
Z12	Snap action 1 NO contact / 2 NC contacts

Contact design

	Silver contacts (Standard)
A1	Gold-plated contacts 0.3 µm
A2	Gold-plated contacts 1.0 µm
A3	Gold-plated contacts 3.0 µm

Roller/lever variants

00 ... 99 | Material and dimension variants

Actuator elements (more on request)

PS116 and PS2xx series

S2	Plunger
R2	Roller plunger
K2	Roller/angle roller lever
H2	Roller lever
N2	Length-adjustable roller lever
J2	Rod lever
F2	Spring rod
A2	Tappet for using safety press

PS3xx series

S2	Plunger, tappet width Ø 6 mm
S3	Plunger, tappet width Ø 9 mm
R3	Roller plunger
K3	Angle roller lever
H3	Roller lever
N3	Length-adjustable roller lever
J3	Rod lever
F2	Spring rod

Termination

	Cable entry M20, screw connection
M16	Cable entry M16, screw connection
ST	Connector plug M12, bottom
STR	Connector plug M12, right
L200	Pre-wired cable bottom, 2 m (PS116 only)
LR200	Pre-wired cable right, 2 m (PS116 only)

For technical reasons, not all possible variations and/or combinations can be delivered.

The existing key type is used to translate the product type designation.

4. PS2XX / PS3XX STANDARDISED CONSTRUCTION FORMS, EXTRAORDINARY FEATURES

FOLDING LATCHING COVER



All plastic versions are fitted with a folding and captive latching cover. The cover can be opened with the aid of a flat-head screwdriver and needs no tools to be closed.

REDUCED ASSEMBLY TIMES

The 45° rotated connection terminals of all switch elements reduce the assembly time considerably.



ACTUATING ELEMENT REPLACE AND TURN

All actuating elements can be rotated in 45° increments and can be quickly replaced and implemented due to the simple mounting design. This means that adaptation to the prescribed actuating direction is possible at any time.

PS116



1. Release locking plate
(flat-head screwdriver or
accessory tool ACC-PS116-1)

2. Remove or turn existing
actuating element

3. Position of new
actuating element

4. Secure locking plate

The symmetrical layout of the enclosure means that it can be used for left-hand and right-hand versions of the same switch. This applies to both the cable and the connector design.

PS2XX / PS3XX



1. Release locking plate
(flat-head screwdriver)

2. Remove or turn existing
actuating element

3. Position of new
actuating element

4. Secure locking plate

4. POSITION SWITCHES

OVERVIEW OF THE SERIES



■ PS116



■ PS215

Key Features

- Symmetrical casing
- Compact design
- Fitted (cable / M12 connector)
- Complete device or modular construction kit
- Design to EN 50047

- Simplified connection (connection terminals rotated by 45°)
- Robust design
- Complete device or modular construction kit
- Design to EN 50047

Technical features

Electrical characteristics		
Switching system	Snap-/slow action	Snap-/slow action
Latching variant	■	■
Max. number of contacts	3	3
Max. switching capacity U/I	240 VAC / 3 A; 24 VDC / 1.5 A	240 VAC / 3 A; 24 VDC / 3 A
Max. switching capacity U/I (M12 connector, 4-pole)	240 VAC / 1.5 A; 24 VDC / 1.5 A	50 VAC / 3 A; 24 VDC / 3 A
Max. switching capacity U/I (M12 connector, 6-pole)	1.5 A / 24 VDC	-
Max. switching capacity U/I (M12 connector, 8-pole)	-	30 VAC / 2 A; 24 VDC / 2 A
Mechanical data		
Housing material	Metal / thermoplastic enclosure	Metal enclosure, painted
Connector	Cable 4/6 pole M12 connector 4/6 pole	1 x M20 M12 connector 5/8 pole
Cable section ³⁾	4/6 x 0.5 mm ²	max. 1.5 mm ² (incl. conductor ferrules)
Dimensions (W x H x D)	31 x 52 x 16.6 mm	31 x 66 x 33 mm
Ambient conditions		
Ambient temperature	-30 °C ... +80 °C	-30 °C ... +80 °C
Degree of protection	IP66, IP67	IP66, IP67
Actuator heads	see page 92	see page 92

Safety classification

Standards	EN ISO 13849-1	EN ISO 13849-1
B _{10D} NC contact	20,000,000	20,000,000
Certificates	cULus, CCC, EAC	cULus, CCC, EAC



To get detailed information about the products and certificates, visit products.schmersal.com.



■ PS216



■ PS226



■ PS315



■ PS316

- Simplified connection (connection terminals rotated by 45°)
- Folding latching cover
- Complete device or modular construction kit
- Design to EN 50047

- Simplified connection (connection terminals rotated by 45°)
- Folding latching cover
- Complete device or modular construction kit
- Design to EN 50047

- Simplified connection (connection terminals rotated by 45°)
- Robust design
- Complete device or modular construction kit
- Design to EN 50041

- Simplified connection (connection terminals rotated by 45°)
- Folding latching cover
- Complete device or modular construction kit
- Design to EN 50041

Snap-/slow action	Snap-/slow action	Snap-/slow action	Snap-/slow action
■	■	–	–
3	3	3	3
240 VAC / 3 A; 24 VDC / 3 A	240 VAC / 3 A; 24 VDC / 3 A	240 VAC / 3 A; 24 VDC / 3 A	240 VAC / 3 A; 24 VDC / 3 A
240 VAC / 3 A; 24 VDC / 3 A	240 VAC / 3 A; 24 VDC / 3 A	50 VAC / 3 A; 24 VDC / 3 A	240 VAC / 3 A; 24 VDC / 3 A
–	–	–	–
30 VAC / 2 A; 24 VDC / 2 A	30 VAC / 2 A; 24 VDC / 2 A	30 VAC / 2 A; 24 VDC / 2 A	30 VAC / 2 A; 24 VDC / 2 A
Plastic housing	Plastic housing	Metal enclosure, painted	Plastic housing
1 x M20 M12 connector 4/8 pole max. 1.5 mm ² (incl. conductor ferrules)	2 x M20 M12 connector 4/8 pole max. 1.5 mm ² (incl. conductor ferrules)	1 x M20 M12 connector 5/8 pole max. 1.5 mm ² (incl. conductor ferrules)	1 x M20 M12 connector 4/8 pole max. 1.5 mm ² (incl. conductor ferrules)
31 x 66 x 33 mm	31 x 59.2 x 33 mm	40 x 77.7 x 37.2 mm	40 x 77.7 x 37.2 mm
–30 °C ... +80 °C IP66, IP67 see page 92	–30 °C ... +80 °C IP66, IP67 see page 92	–30 °C ... +80 °C IP66, IP67 see page 96	–30 °C ... +80 °C IP66, IP67 see page 96
EN ISO 13849-1 20,000,000 cULus, CCC, EAC	EN ISO 13849-1 20,000,000 cULus, CCC, EAC	EN ISO 13849-1 20,000,000 cULus, CCC, EAC	EN ISO 13849-1 20,000,000 cULus, CCC, EAC

4. POSITION SWITCHES

PS116 / PS2XX – ACTUATOR HEADS



Plunger S200



Roller plunger R200

Actuator heads

Actuator description	Thermoplastic plunger Actuator type B according to EN 50047	Thermoplastic roller plunger Actuator type C according to EN 50047
Positive break force	> 40 N	> 40 N
Actuating speed	min. 10 mm/min, max. 0.5 m/s	min. 10 mm/min, max. 0.5 m/s
Snap action		
Slow action	min. 60 mm/min, max. 0.5 m/s	min. 60 mm/min, max. 0.5 m/s
Positioning the lever	–	–

Ordering data modular construction kit

Product type description	PS-S200	PS-R200
Material number	103010968	103010967

Switch travel diagrams

Snap action	Per NO contact / per NC contact		
Slow action	Per NO contact / per NC contact		
	1 NO / 1 NC with overlapping		
	2 NC with staggered contacts		

■ Contact closed

□ Contact open

Ⓟ Positive break travel / angle



Offset roller lever K200



Offset roller lever K210



Angle roller lever K230

Thermoplastic offset roller lever
Actuator type E according to EN 50047
> 40 N
min. 10 mm/min,
max. 1 m/s
min. 60 mm/min,
max. 1 m/s
-

Thermoplastic offset roller lever
> 40 N
min. 10 mm/min,
max. 1 m/s
min. 60 mm/min,
max. 1 m/s
-

Thermoplastic angle roller lever
> 40 N
min. 10 mm/min,
max. 1 m/s
min. 60 mm/min,
max. 1 m/s
-

PS-K200
103010961

PS-K210
103010962

PS-K230
103010963

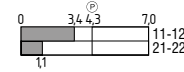
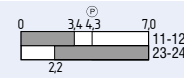
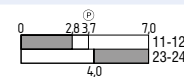
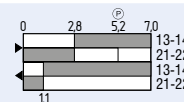
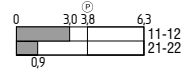
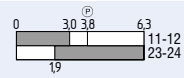
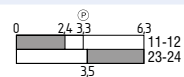
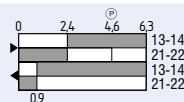
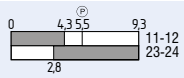
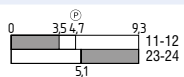
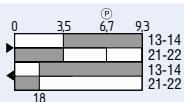

4. POSITION SWITCHES

PS116 / PS2XX – ACTUATOR HEADS



Angle roller lever K240

Angle roller lever K250

Actuator heads

Actuator description	Thermoplastic angle roller lever	Thermoplastic angle roller lever
Positive break force	> 40 N	> 40 N
Actuating speed	min. 10 mm/min, max. 1 m/s	min. 10 mm/min, max. 1 m/s
Snap action		
Slow action	min. 60 mm/min, max. 1 m/s	min. 60 mm/min, max. 1 m/s
Positioning the lever	-	-

Ordering data modular construction kit

Product type description	PS-K240	PS-K250
Material number	103010964	103010965

Switch travel diagrams

Snap action	Per NO contact / per NC contact		
Slow action	Per NO contact / per NC contact		
	1 NO / 1 NC with overlapping		
	2 NC with staggered contacts		

■ Contact closed

□ Contact open

Ⓟ Positive break travel / angle



Roller lever H200



Roller lever N200



Roller lever J200

Metal lever with plastic roller
Actuator type A according to EN 50047

Length adjustable metal lever
with plastic roller
adjustable in 2 mm increments

Plastic rod, 200 mm
Can only be used for positioning tasks

> 40 N

min. 10 mm/min,
max. 1 m/s

min 60 mm/min,
max. 1 m/s

adjustable in 15° steps

> 40 N

min. 10 mm/min,
max. 1 m/s

min. 60 mm/min,
max. 1 m/s

adjustable in 15° steps

–

min. 10 mm/min,
max. 1 m/s

min 60 mm/min,
max. 1 m/s

adjustable in 15° steps

PS-H200
103010948

PS-N200
103010966

PS-J200
103010951

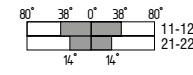
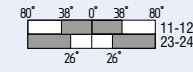
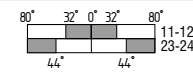
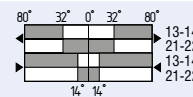
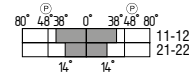
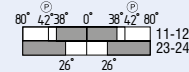
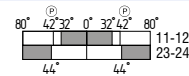
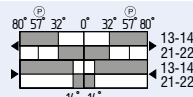
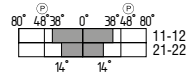
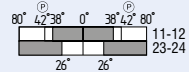
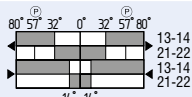

4. POSITION SWITCHES

PS3XX – ACTUATOR HEADS



Plunger S300



Roller plunger R300

Actuator heads

Actuator description	Thermoplastic plunger Actuator type B according to EN 50041	Thermoplastic roller plunger Actuator type C according to EN 50041
Positive break force	> 50 N	> 50 N
Actuating speed	min. 10 mm/min, max. 0.5 m/s	min. 10 mm/min, max. 0.5 m/s
Snap action		
Slow action	min. 60 mm/min, max. 0.5 m/s	min. 60 mm/min, max. 0.5 m/s
Positioning the lever	-	-

Ordering data modular construction kit

Product type description	PS-S300	PS-R300
Material number	103015397	103015398

Switch travel diagrams

Snap action	Per NO contact / per NC contact		
Slow action	Per NO contact / per NC contact		
	1 NO / 1 NC with overlapping		
	2 NC with staggered contacts		

Contact closed

Contact open

Positive break travel / angle



Angle roller lever K360



Offset roller lever K370



Roller lever H300

Thermoplastic angle roller lever	Thermoplastic offset roller lever	Metal lever with plastic roller Actuator type A according to EN 50041
> 50 N min. 10 mm/min, max. 1 m/s min. 60 mm/min, max. 1 m/s -	> 50 N min. 10 mm/min, max. 1 m/s min. 60 mm/min, max. 1 m/s -	> 50 N min. 10 mm/min, max. 1 m/s min. 60 mm/min, max. 1 m/s adjustable in 15° steps
PS-K360 103015399	PS-K370 103015400	PS-H300 103015401

4. POSITION SWITCHES

PS3XX – ACTUATOR HEADS



Roller lever N300 | **Roller lever J300**

Actuator heads

Actuator description	Length adjustable metal lever with plastic roller adjustable in 2 mm increments	Plastic rod, 200 mm Can only be used for positioning tasks Actuator type A according to EN 50041
Positive break force	> 50 N	–
Actuating speed	min. 10 mm/min, max. 1 m/s	min. 10 mm/min, max. 1 m/s
Snap action		
Slow action	min. 60 mm/min, max. 1 m/s	min. 60 mm/min, max. 1 m/s
Positioning the lever	adjustable in 15° steps	adjustable in 15° steps

Ordering data modular construction kit

Product type description	PS-N300	PS-J300
Material number	103015402	103015403

Switch travel diagrams

Snap action	Per NO contact / per NC contact		
Slow action	Per NO contact / per NC contact		
	1 NO / 1 NC with overlapping		
	2 NC with staggered contacts		

■ Contact closed

□ Contact open

Ⓟ Positive break travel / angle

UP-TO-DATE WITHOUT FAIL THE SCHMERSAL WEBSHOP

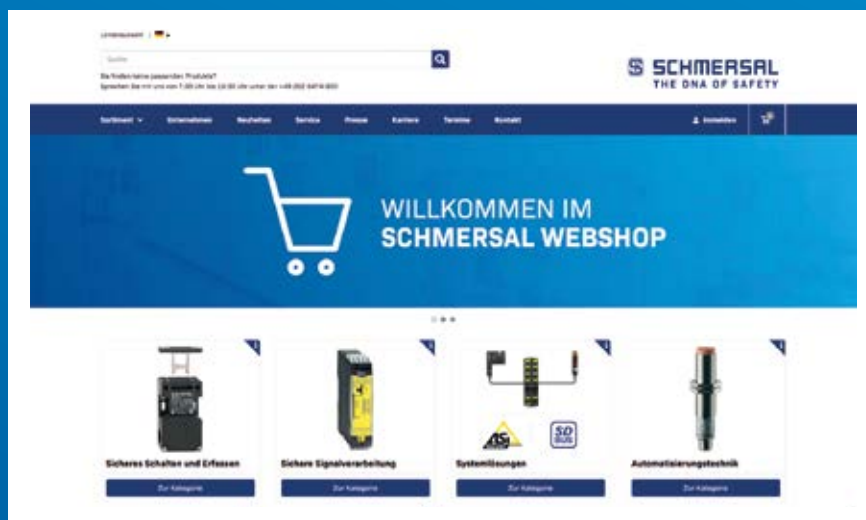

FOR DETAILED INFORMATION, CHECK OUT
[PRODUCTS.SCHMERSAL.COM](https://products.schmersal.com)

4. POSITION SWITCHES

PS116 – PREFERRED TYPES AND ORDERING DETAILS



Position switch with actuating element	Termination	Switching system	NO contacts	NC contacts	Type	Material number		
S200 Basic switch	Connector plug	Snap action	1	1	PS116-Z11-ST-S200	103006651		
			1	2	PS116-Z12-ST-S200	103006662		
		Slow action	1	1	PS116-T11-ST-S200	103006652		
	Pre-wired cable	Snap action	1	1	PS116-Z11-L200-S200	103006633		
			1	2	PS116-Z12-L200-S200	103006647		
		Snap action with latch	1	1	PS116-Z11R-L200-S200	103009907		
			0	2	PS116-Z02R-L200-S200	103012043		
		Slow action	1	1	PS116-T11-L200-S200	103006634		
		R200	Connector plug	Snap action	1	1	PS116-Z11-ST-R200	103006653
0	2				PS116-Z02-ST-R200	103008391		
1	2				PS116-Z12-ST-R200	103006663		
Snap action with latch	1			2	PS116-Z12R-ST-R200	103009897		
	1			1	PS116-T11-ST-R200	103006654		
2	1			PS116-T21-ST-R200	103009215			
Pre-wired cable	Snap action		1	1	PS116-Z11-L200-R200	103006635		
			1	1	PS116-T11-L200-R200	103006636		
	Slow action		1	2	PS116-T12-L200-R200	103006648		
			1	1	PS116-T11-L200-R200	103006636		
	K200		Connector plug	Snap action	1	1	PS116-Z11-ST-K200	103006655
					1	2	PS116-Z12-ST-K200	103006664
Pre-wired cable		1		1	PS116-Z11-L200-K200	103006637		
K210		Connector plug	Snap action	1	1	PS116-Z11-ST-K210	103006656	
				1	2	PS116-Z12-ST-K210	103009491	
			Slow action	1	1	PS116-T11-ST-K210	103006657	
	2			1	PS116-T21-ST-K210	103013834		
	Pre-wired cable	Snap action	1	1	PS116-Z11-L200-K210	103006638		
		Snap action with latch	1	2	PS116-Z12R-L200-K210	103009906		
Slow action		1	1	PS116-T11-L200-K210	103006639			
K230	Connector plug	Snap action	1	1	PS116-Z11-ST-K230	103006658		
		Slow action	0	2	PS116-T02-ST-K230	103014690		
	Pre-wired cable	Snap action	1	1	PS116-Z11-L200-K230	103006640		
			0	2	PS116-Z02-L200-K230	103011608		
		Slow action	1	1	PS116-T11-L200-K230	103006641		
K240	Connector plug	Snap action	1	2	PS116-Z12-ST-K240	103006665		
	Pre-wired cable		1	1	PS116-Z11-L200-K240	103006641		
K250	Connector plug	Snap action	1	2	PS116-Z12-ST-K250	103006666		
		Slow action	1	2	PS116-T12-ST-K250	103006667		
	Pre-wired cable	Snap action	1	1	PS116-Z11-L200-K250	103006642		
			1	1	PS116-T11-L200-K250	103006643		
		Slow action	1	2	PS116-T12-L200-K250	103015281		
			1	2	PS116-T12-L200-K250	103015281		

To see a wide range of other types, visit products.schmersal.com.

4. POSITION SWITCHES

PS116 – PREFERRED TYPES AND ORDERING DETAILS



Position switch with actuating element	Termination	Switching system	NO contacts	NC contacts	Type	Material number
H200	Connector plug	Snap action	1	1	PS116-Z11-ST-H200	103006659
			1	2	PS116-Z12-ST-H200	103009490
		Slow action	1	1	PS116-T11-ST-H200	103006660
			1	2	PS116-T12-ST-H200	103006668
			0	3	PS116-T03-ST-H200	103012315
	Pre-wired cable	Snap action	1	1	PS116-Z11-L200-H200	103006644
		Slow action	1	1	PS116-T11-L200-H200	103006645
			1	2	PS116-T12-L200-H200	103006649
	N200	Connector plug	Snap action	1	1	PS116-Z11-ST-N200
1				2	PS116-Z12-ST-N200	103010921
Slow action			1	1	PS116-T11-ST-N200	103011367
			2	0	PS116-T20-ST-N200	103010065
			1	2	PS116-T12-ST-N200	103011553
			2	1	PS116-T21-ST-N200	103010067
Pre-wired cable		Snap action	1	1	PS116-Z11-L200-N200	103006646
			1	2	PS116-Z12-L200-N200	103008748
		Slow action	1	2	PS116-T12-L200-N200	103006650
J200	Connector plug	Slow action with staggered contacts	0	2	PS116-T02H-ST-J200	103014413

4. POSITION SWITCHES

PS2XX – PREFERRED TYPES AND ORDERING DETAILS



Position switch with actuating element	Switching system	NO contacts	NC contacts	Type	Material number		
S200 Basic switch	PS215 Metal	Snap action	1	1	PS215-Z11-S200	103014952	
			0	2	PS215-Z02-S200	103014953	
			1	2	PS215-Z12-S200	103014954	
		Slow action	1	1	PS215-T11-S200	103014977	
			0	2	PS215-T02-S200	103014978	
			1	2	PS215-T12-S200	103014979	
	PS216 Thermoplastic	Snap action	1	1	PS216-Z11-S200	103013713	
			0	2	PS216-Z02-S200	103015001	
			1	2	PS216-Z12-S200	103015002	
		Slow action	1	1	PS216-T11-S200	103015022	
			0	2	PS216-T02-S200	103015023	
			1	2	PS216-T12-S200	103015024	
	PS226 Thermoplastic	Snap action	1	1	PS226-Z11-S200	103015048	
			0	2	PS226-Z02-S200	103015049	
			1	2	PS226-Z12-S200	103015050	
		Slow action	1	1	PS226-T11-S200	103015073	
			0	2	PS226-T02-S200	103015074	
			1	2	PS226-T12-S200	103015075	
	R200	PS215 Metal	Snap action	1	1	PS215-Z11-R200	103014955
			Slow action	1	1	PS215-T11-R200	103014981
		PS216 Plastic	Snap action	1	1	PS216-Z11-R200	103015003
0				2	PS216-Z02-R200	103015004	
1				2	PS216-Z12-R200	103015005	
Slow action			1	1	PS216-T11-R200	103015028	
			0	2	PS216-T02-R200	103015029	
			1	2	PS216-T12-R200	103015030	
PS226 Thermoplastic		Snap action	1	1	PS226-Z11-R200	103015051	
		Slow action	1	1	PS226-T11-R200	103015076	

To see a wide range of other types, visit products.schmersal.com.

4. POSITION SWITCHES

PS2XX – PREFERRED TYPES AND ORDERING DETAILS



Position switch with actuating element		Switching system	NO contacts	NC contacts	Type	Material number	
K200	PS216 Plastic	Snap action	1	1	PS216-Z11-K200	103015006	
		Slow action	1	1	PS216-T11-K200	103015031	
K210	PS215 Metal	Snap action	1	1	PS215-Z11-K210	103014960	
		Slow action	1	1	PS215-T11-K210	103014963	
	PS216 Thermoplastic	Snap action	1	1	PS216-Z11-K210	103015008	
		Slow action	1	1	PS216-T11-K210	103015033	
K230	PS215 Metal	Snap action	1	1	PS215-Z11-K230	103014963	
		Slow action	1	1	PS215-T11-K230	103014988	
	PS216 Thermoplastic	Snap action	1	1	PS216-Z11-K230	103015010	
		Slow action	1	1	PS216-T11-K230	103015035	
	K240	PS215 Metal	Slow action	1	1	PS215-T11-K240	103014991
			Snap action	1	1	PS216-Z11-K240	103015013
PS216 Thermoplastic		Slow action	1	1	PS216-T11-K240	103015038	
		Snap action	1	1	PS226-Z11-K240	103015061	
K250	PS216 Thermoplastic	Snap action	1	1	PS216-Z11-K250	103015015	
		Slow action	1	1	PS216-T11-K250	103015040	
H200	PS215 Metal	Slow action	1	1	PS215-T11-H200	103014995	
		Snap action	1	1	PS216-Z11-H200	103013857	
	PS216 Thermoplastic	Slow action	1	1	PS216-T11-H200	103015042	
		Slow action	1	2	PS216-T12-H200	103015043	
		Snap action	1	2	PS216-Z12-H200	103015017	
		Snap action	1	2	PS216-Z12-H200	103015017	
N200	PS215 Metal	Snap action	1	1	PS215-Z11-N200	103014972	
		Slow action	1	1	PS215-T11-N200	103014997	
	PS216 Thermoplastic	Snap action	1	1	PS216-Z11-N200	103015018	
		Snap action	1	2	PS216-Z12-N200	103015019	
		Slow action	1	1	PS216-T11-N200	103015044	
		Slow action	1	2	PS216-T12-N200	103015045	
		Snap action	1	1	PS216-Z11-N200	103015018	
		Snap action	1	2	PS216-Z12-N200	103015019	
J200	PS215 Metal	Snap action	1	1	PS215-Z11-J200	103014974	
	PS216 Thermoplastic	Snap action	1	1	PS216-Z11-J200	103015020	

4. POSITION SWITCHES

PS3XX – PREFERRED TYPES AND ORDERING DETAILS



Position switch with actuating element	Switching system	NO contacts	NC contacts	Type	Material number		
S200 Basic switch	PS315 Metal	Snap action	1	1	PS315-Z11-S200	103015406	
			0	2	PS315-Z02-S200	103015407	
			1	2	PS315-Z12-S200	103015408	
		Slow action	1	1	PS315-T11-S200	103015412	
			0	2	PS315-T02-S200	103015414	
			1	2	PS315-T12-S200	103015415	
	PS316 Thermoplastic	Snap action	1	1	PS316-Z11-S200	103015409	
			0	2	PS316-Z02-S200	103015410	
			1	2	PS316-Z12-S200	103015411	
		Slow action	1	1	PS316-T11-S200	103015417	
			0	2	PS316-T02-S200	103015418	
			1	2	PS316-T12-S200	103015419	
	S300	PS315 Metal	Snap action	1	1	PS315-Z11-S300	103015096
				0	2	PS315-Z02-S300	103015097
				1	2	PS315-Z12-S300	103015098
Slow action			1	1	PS315-T11-S300	103015112	
			0	2	PS315-T02-S300	103015113	
			1	2	PS315-T12-S300	103015114	
PS316 Thermoplastic		Snap action	1	1	PS316-Z11-S300	103015129	
			0	2	PS316-Z02-S300	103015130	
			1	2	PS316-Z12-S300	103015131	
		Slow action	1	1	PS316-T11-S300	103015146	
			0	2	PS316-T02-S300	103015147	
			1	2	PS316-T12-S300	103015148	
R300		PS315 Metal	Snap action	1	1	PS315-Z11-R300	103015099
				0	2	PS315-Z02-R300	103015100
			Slow action	1	1	PS315-T11-R300	103015116
	0			2	PS315-T02-R300	103015117	
	PS316 Thermoplastic	Snap action	1	1	PS316-Z11-R300	103015132	
			0	2	PS316-Z02-R300	103015133	
		Slow action	1	1	PS316-T11-R300	103015152	
			0	2	PS316-T02-R300	103015153	

To see a wide range of other types, visit products.schmersal.com.

4. POSITION SWITCHES

PS3XX – PREFERRED TYPES AND ORDERING DETAILS



Position switch with actuating element		Switching system	NO contacts	NC contacts	Type	Material number
K360	PS315 Metal	Snap action	1	1	PS315-Z11-K360	103015102
		Slow action	1	1	PS315-T11-K360	103015119
	PS316 Thermoplastic	Snap action	1	1	PS316-Z11-K360	103015135
		Slow action	1	1	PS316-T11-K360	103015155
K370	PS315 Metal	Snap action	1	1	PS315-Z11-K370	103015104
		Slow action	1	1	PS315-T11-K370	103015121
	PS316 Thermoplastic	Snap action	1	1	PS316-Z11-K370	103015137
		Slow action	1	1	PS316-T11-K370	103015157
H300	PS315 Metal	Snap action	1	1	PS315-Z11-H300	103015106
		Slow action	1	1	PS315-T11-H300	103015123
	PS316 Thermoplastic	Snap action	1	1	PS316-Z11-H300	103015139
		Slow action	1	1	PS316-T11-H300	103015159
			1	2	PS316-T12-H300	103015160
N300	PS315 Metal	Snap action	1	1	PS315-Z11-N300	103015108
		Slow action	1	1	PS315-T11-N300	103015125
	PS316 Thermoplastic	Snap action	1	1	PS316-Z11-N300	103015141
		Slow action	1	1	PS316-T11-N300	103015161
			1	2	PS316-T12-N300	103015162
J300	PS315 Metal	Snap action	1	1	PS315-Z11-J300	103015110
		Slow action	1	1	PS315-T11-J300	103015127
	PS316 Thermoplastic	Snap action	1	1	PS316-Z11-J300	103015143
		Slow action	1	1	PS316-T11-J300	103015163

5. SAFETY SWITCHES FOR HINGED GUARDS

DESCRIPTION

AREA OF APPLICATION

When considering the position monitoring of rotating protection equipment, the designer has different choices. For instance standard safety switches with separate actuator (page 10), position switches with safety function (page 84) and safety sensors with different working principles (page 116); the designer can also decide on hinged safety switches.

Both small rotating doors and service flaps as well as heavy doors of machines and equipment can be constructed using this special type of safety switches, which are easy to assemble and are manipulation protected. A further benefit is the very compact construction and the attractive, unobtrusive design. Therefore safety hinged switches are frequently used in design-oriented machines and equipment.

DESIGN AND WAY OF FUNCTIONING

A cam is integrated in the safety switches that triggers the safety function at a specific angle. Thus, the requirement in the EN ISO 14119 for positive linkage between cam and actuator is fulfilled. Depending on the design, the designer can eliminate one construction element, because the safety switch also acts as a hinge. This ensures a high degree of protection against manipulation, as the safety function is hidden in the hinge cover. In addition, the requirement for a compact design and a convenient access to the working area of the machine is established. No switching element is required on the opening side of the safety door.

Information for the selection of suitable safety relay modules can be found in the chapter "Safety relay modules" (refer to page 220).



SERIES

The Schmersal Group offers three different series of safety hinged switches.

The Series T.C. 235 / 236, based on the well-proven position switches with safety function and is suitable for the position monitoring of maintenance flaps and smaller rotating doors (see from page 108).

With the Series TV.S, the safety hinged switches are mounted on a door hinge using a shaft or a hinged shaft on the door hinge (see page 110). This is mainly used with heavy doors.

The TESK and TESZ Series were designed for general use on safety doors of machinery and equipment (see page 112). The central properties of these safety hinged switches is the adaptation of the hinging function, such as with the TESK, along with the freely adjustable switching angle across the entire working range and a minimal installation effort in particular with common aluminium profile systems. A fixture on the door ensures rapid alignment on the door and post.

The user can select between different contact variants with up to four contacts, as well as between wire and plug connectors. For use on transparent safety doors made from plastic there is a version with an extended hinge available.

5. SAFETY SWITCHES FOR HINGED GUARDS

HINGE SAFETY SWITCH – SERIES SUMMARY



■ 235



■ 236

Key Features

- Metal enclosure
- Max. 2 contacts
- Design EN 50047

- Thermoplastic enclosure
- Max. 2 contacts
- Design EN 50047

Other versions

ATEX / IECEx

–

–

AS-i SaW (see page 258)

■

■

Technical features

Electrical characteristics

Max. switching capacity U/I

230 VAC / 4 A;
24 VDC / 1 A

230 VAC / 4 A;
24 VDC / 1 A

Mechanical data

Housing material

Zinc die-cast, paint finish

Glass-fibre reinforced
thermoplastic

Termination

Screw terminal or
M12 connector

Screw terminal or
M12 connector

Cable section

0.75 ... 2.5 mm²

0.75 ... 2.5 mm²

Dimensions (W x H x D)

30 x 63.5 x 30 mm

30 x 61.5 x 30 mm

Ambient conditions

Ambient temperature

–30 °C ... +80 °C

–30 °C ... +80 °C

Degree of protection

IP67

IP67

Safety classification

Standards

EN ISO 13849-1

EN ISO 13849-1

B_{10D} NC contact

20,000,000

20,000,000

Certificates

BG, cULus, CCC, EAC

BG, cULus, CCC, EAC



To get detailed information about the products and certificates, visit products.schmersal.com.

5. SAFETY SWITCHES FOR HINGED GUARDS

FLAP SAFETY SWITCHES – PREFERRED TYPES

Series	Enclosure	Lever	Termination	Contacts	Type	Material number	
235	Metal film	Left-hand model	Cable entry M20	1 NC	T3C 235-01Z	101103648	
				2 NC	T3C 235-02Z-M20	101171209	
				1 NO / 1 NC	T3C 235-11Z-M20	101154218	
			M12 connector, 8 pole	1 NO / 1 NC	T3C 235-11Z-ST	101181433	
		Swing-door model	Cable entry M20	1 NC	T4C 235-01Z	101103651	
				2 NC	T4C 235-02Z-M20	101154990	
				1 NO / 1 NC	T4C 235-11Z-M20	101154291	
		Right-hand model	Cable entry M20	1 NC	T5C 235-01Z	101104201	
				2 NC	T5C 235-02Z-M20	101157475	
				1 NO / 1 NC	T5C 235-11Z-M20	101154219	
			M12 connector, 8 pole	1 NO / 1 NC	T5C 235-11Z-ST	101181431	
		236	Thermoplastic	Left-hand model	Cable entry M20	1 NC	T3C 236-01Z
2 NC	T3C 236-02Z-M20					101164466	
1 NO / 1 NC	T3C 236-11Z-M20					101162012	
Cable entry M16	1 NO / 1 NC				T3C 236-11Z-M16	101122970	
	M12 connector, 8 pole				2 NC	T3C 236-02Z-ST	101199528
					1 NO / 1 NC	T3C 236-11Z-ST	101212224
Swing-door model	Cable entry M20			1 NC	T4C 236-01Z	101108151	
				2 NC	T4C 236-02Z-M20	101162635	
				1 NO / 1 NC	T4C 236-11Z-M20	101164465	
	Cable entry M16			1 NO / 1 NC	T4C 236-11Z-M16	101122397	
				M12 connector, 8 pole	2 NC	T4C 236-02Z-ST	103000113
					1 NO / 1 NC	T4C 236-11Z-ST	101108153
Right-hand model	Cable entry M20			1 NC	T5C 236-01Z	101108153	
				2 NC	T5C 236-02Z-M20	101164467	
				1 NO / 1 NC	T5C 236-11Z-M20	101153304	
	Cable entry M16			1 NO / 1 NC	T5C 236-11Z-M16	101123244	
				M12 connector, 8 pole	2 NC	T5C 236-02Z-ST	101196348
					1 NO / 1 NC	T5C 236-11Z-ST	101212124

5. SAFETY SWITCHES FOR HINGED GUARDS

HINGE SWITCH WITH ACTUATOR SHAFT – SERIES SUMMARY



■ 335



■ 355

Key Features

- Metal enclosure
- Max. 3 contacts
- Design EN 50041

- Metal enclosure
- Max. 3 contacts
- Design EN 50041

Other versions

ATEX / IECEx

-

-

AS-i SaW (see page 258)

■

-

Technical features

Electrical characteristics

Max. switching capacity U/I

230 VAC / 4 A;
24 VDC / 4 A

230 VAC / 4 A;
24 VDC / 4 A

Mechanical data

Housing material

Aluminium die-cast, paint finish

Aluminium die-cast, paint finish

Termination

Screw terminal or M12 connector

Screw terminal or M12 connector

Cable section

0.75 ... 2.5 mm²

0.75 ... 2.5 mm²

Dimensions (W x H x D)

40.5 x 76 x 38 mm

66.7 x 76 x 38 mm

Ambient conditions

Ambient temperature

-25 °C ... +70 °C

-25 °C ... +70 °C

Degree of protection

IP67

IP67

Safety classification

Standards

EN ISO 13849-1

EN ISO 13849-1

B₁₀₀ NC contact

20,000,000

20,000,000

Certificates

BG, cULus, CCC

BG, cULus, CCC

¹⁾ There is the possibility to feed the connection line through



To get detailed information about the products and certificates, visit products.schmersal.com.

5. SAFETY SWITCHES FOR HINGED GUARDS

HINGE SWITCH WITH ACTUATOR SHAFT – PREFERRED TYPES

Range	Design	Shaft Ø	Termination	Contacts	Type	Material number
335	Slim design	8 mm	M12 x 1 connector	2 NC	TV8S 335-02Z-ST	101210086
			Cable entry M20	2 NC	TV8S 335-02Z-M20	101168631
				3 NC	TV8S 335-03Z	101179251
				1 NO / 1 NC	TV8S 335-11Z-G24	101117213
				1 NO / 1 NC	TV8S 335-11Z-M20	101155141
				1 NO / 2 NC	TV8S 335-12Z	101179250
		M12 x 1 connector		2 NC	TV10S 335-02Z-ST	101157472
		10 mm	Cable entry M20	2 NC	TV10S 335-02Z-M20	101157473
				3 NC	TV10S 335-03Z	101179253
				1 NO / 1 NC	TV10S 335-11Z-G24	101117215
				1 NO / 1 NC	TV10S 335-11Z-M20	101160104
				1 NO / 2 NC	TV10S 335-12Z	101179252
				M12 x 1 connector	2 NC	TV8S 355-02Z-ST
		355	Large design	8 mm	Cable entry 3 x M20	2 NC
3 NC	TV8S 355-03Z					101179255
1 NO / 1 NC	TV8S 355-11Z					101117209
1 NO / 2 NC	TV8S 355-12Z					101179254
2 NC	TV10S 355-02Z					101117212
3 NC	TV10S 355-03Z					101179258
10 mm	Cable entry 3 x M20			1 NO / 1 NC	TV10S 355-11Z	101117211
				1 NO / 2 NC	TV10S 355-12Z	101179256

5. SAFETY SWITCHES FOR HINGED GUARDS

HINGE SWITCH AS SWITCH HINGE – SERIES SUMMARY



■ TESZ



■ TESK

Key Features

- | | |
|---|---|
| <ul style="list-style-type: none"> ▪ Available as stainless steel hinge ▪ Versions for profile systems in 30, 35, 40 and 45 mm ▪ Max. 3 contacts ▪ Restart Interlock (manual reset) | <ul style="list-style-type: none"> ▪ Optimised for profile system ▪ Freely adjustable switching angle ▪ Large swivel angle of 270° ▪ Suitable for use with shuttle valves ▪ For external and internal use ▪ Max. 4 contacts |
|---|---|

Technical features

Electrical characteristics		
Max. switching capacity U/I	230 VAC / 2 A (only screw terminal); 24 VDC / 1 A	230 VAC / 2 A (only cable) 24 VDC / 1 A
Switching of low voltages	1 mA / 5VDC	1 mA / 3VDC
Mechanical data		
Housing material	Glass-fibre reinforced thermoplastic and aluminium	Zinc die-cast
Termination	M12 connector plug, 8-pole / screw terminal	M12 connector plug, 5-pole / 8-pole / cable
Opening angle	135°	270°
Positive break angle	10°	10°
Switching frequency	120/h	120/h
Ambient conditions		
Ambient temperature	-25 °C ... +65 °C	-25 °C ... +65 °C
Degree of protection	IP65	IP65

Safety classification

Standards	EN ISO 13849-1	EN ISO 13849-1
B_{10D} NC contact	2,000,000	2,000,000
Certificates	BG, cULus, BG, cULus, EAC	BG, cULus, EAC



To get detailed information about the products and certificates, visit products.schmersal.com.

5. SAFETY SWITCHES FOR HINGED GUARDS

TESZ – PREFERRED TYPES

Range	Hinge	Profile system	Contacts	Type	Material number	
TESZ	Aluminium	30 mm	2 NC/1 NO	TESZ1102/S/30	101030509	
			3 NC	TESZ1110/S/30	101030510	
		35 mm	2 NC/1 NO	TESZ1102/S/35	101030520	
			3 NC	TESZ1110/S/35	103014568	
		40 mm	2 NC/1 NO	TESZ1102/S	101029153	
			3 NC	TESZ1110/S	101029152	
		45 mm	2 NC/1 NO	TESZ1102/S/45	101030531	
			3 NC	TESZ1110/S/45	103014569	
		Stainless steel	40 mm	2 NC/1 NO	TESZX1102/S	101031672
				3 NC	TESZX1110/S	101031673
TESZ	Additional hinge	Profile system	Type	Material number		
	Aluminium	30 mm	TESZ/S/30	101030511		
		35 mm	TESZ/S/35	101030522		
		40 mm	TES/S	101027080		
		45 mm	TES/S/45	101028411		
	Stainless steel	40 mm	TESZX/S	101031680		

5. SAFETY SWITCHES FOR HINGED GUARDS

TESK – PREFERRED TYPES

Range	Hinge	Factory setting	Contacts	Termination	Type	Material number	
TESK	Standard hinge	Mounting outside	1 NO / 1 NC	Connector plug	bottom	TESK-SA-11ST1	103005743
					above	TESK-SA-11ST2	103005744
			Cable	bottom	TESK-SA-11L1-3M	103005740	
				above	TESK-SA-11L2-3M	103005742	
			1 NO / 2 NC	Connector plug	bottom	TESK-SA-12ST1	103005747
					above	TESK-SA-12ST2	103005748
		Cable	bottom	TESK-SA-12L1-3M	103005745		
			above	TESK-SA-12L2-3M	103005746		
		Mounting inside	1 NO / 1 NC	Connector plug	bottom	TESK-SI-11ST1	103005751
					above	TESK-SI-11ST2	103005752
			Cable	bottom	TESK-SI-11L1-3M	103005749	
				above	TESK-SI-11L2-3M	103005750	
			1 NO / 2 NC	Connector plug	bottom	TESK-SI-12ST1	103005755
					above	TESK-SI-12ST2	103005756
		Cable	bottom	TESK-SI-12L1-3M	103005753		
			above	TESK-SI-12L2-3M	103005754		
		Universal	1 NO / 1 NC	Connector plug	bottom	TESK-SU-11ST1	103005759
					above	TESK-SU-11ST2	103005760
				Cable	bottom	TESK-SU-11L1-3M	103005757
					above	TESK-SU-11L2-3M	103005758
			1 NO / 2 NC	Connector plug	bottom	TESK-SU-12ST1	103005763
					above	TESK-SU-12ST2	103005764
				Cable	bottom	TESK-SU-12L1-3M	103005761
					above	TESK-SU-12L2-3M	103005762
2 NO / 2 NC	Connector plug		bottom	TESK-SU-22ST1	103007170		
			above	TESK-SU-22ST2	103007172		
Additional hinge					Type	Material number	
For standard hinge					TESK-ZS	103002968	

5. SAFETY SWITCHES FOR HINGED GUARDS

TESK – PREFERRED TYPES

Range	Hinge	Factory setting	Contacts	Termination		Type	Material number
TESK	Long hinge	Mounting outside	1 NO / 1 NC	Connector plug	bottom	TESK-LA-11ST1	103005717
					above	TESK-LA-11ST2	103005718
			Cable	bottom	TESK-LA-11L1-3M	103005712	
				above	TESK-LA-11L2-3M	103005716	
			1 NO / 2 NC	Connector plug	bottom	TESK-LA-12ST1	103005721
					above	TESK-LA-12ST2	103005722
		Cable	bottom	TESK-LA-12L1-3M	103005719		
			above	TESK-LA-12L2-3M	103005720		
		Mounting inside	1 NO / 1 NC	Connector plug	bottom	TESK-LI-11ST1	103005727
					above	TESK-LI-11ST2	103002969
			Cable	bottom	TESK-LI-11L1-3M	103005723	
				above	TESK-LI-11L2-3M	103005724	
			1 NO / 2 NC	Connector plug	bottom	TESK-LI-12ST1	103005730
					above	TESK-LI12-ST2	103005731
		Cable	bottom	TESK-LI-12L1-3M	103005728		
			above	TESK-LI-12L2-3M	103005729		
		Universal	1 NO / 1 NC	Connector plug	bottom	TESK-LU-11ST1	103005734
					above	TESK-LU-11ST2	103005735
			Cable	bottom	TESK-LU-11L1-3M	103005732	
				above	TESK-LU-11L2-3M	103005733	
			1 NO / 2 NC	Connector plug	bottom	TESK-LU-12ST1	103005737
					above	TESK-LU-12ST2	103005738
			Cable	bottom	TESK-LU-12L1-3M	103002970	
				above	TESK-LU-12L2-3M	103005736	
2 NO / 2 NC	Connector plug		bottom	TESK-LU-22ST1	103007173		
			above	TESK-LU-22ST2	103007174		
Additional hinge						Type	Material number
For long hinge						TESK-ZL	103002966

6. SAFETY SENSORS DESCRIPTION

AREA OF APPLICATION

In contrast to the electro-mechanical "type 2" - safety switches, safety sensors allow contactless position sensing of safety doors. This is for the benefit of machines, where it is likely to have a high amount of dust and contamination, and in hygiene-sensitive areas such as for machinery and equipment that are used to produce foodstuffs.

The foodstuff mechanical engineering industry was one of the first sectors to use safety solenoid switches instead of electromechanical safety switches, this was in the nineteen-eighties.

Meanwhile, the application area for safety sensors has significantly expanded. One reason for this is the wide range of products, that includes quite varied designs of safety-solenoid switches. In addition, there are series that are innovative and use the active principle for sensor target communication developed by Schmersal.

These series with the identifier CSS and RSS provide additional benefits such as increased tolerance against safety door offset, simplified safe signal evaluation and deployment of diagnostic-relevant information. Also the increased degree of protection against manipulation such as by individual coding is a motive for many mechanical engineers for the use of electronic safety sensors.

All class 2 safety sensors shown in this section correspond to at least IP65 / IP67 degree of protection and can be used in conjunction with an appropriate safety relay module that reach the performance level d and e according to EN ISO 13849-1.

Information for the selection of suitable safety relay modules can be found in the chapter "Safety relay modules" (refer to page 220).

Included in the Schmersal Group safety sensor range includes versions with integrated AS-i SaW interface (AS-Interface Safety at Work). They take advantage of the simple and proven bus system based on the open standards AS-International and can be integrated over the appropriate system modules in parent communication networks ("Safety Integrated" / "Separated Safety").



DESIGN AND WAY OF FUNCTIONING

Regardless of the mode of operation, the safety sensors each have a sensor and a target that communicate with each other without making contact. If the sensor detects the target, the safety door and safety circuit are closed, and the machine can be started. Opening the safety door interrupts the safety circuit and the machine or the hazardous movement is safely shut down.

This basic principle is always the same. The method of detection for the various sensor families is however different.

MAGNETIC SAFETY SENSORS BNS

The safety-solenoid switches of the BNS-series use the proven principle of safe magnet technology. These electro-sensitive safety switchgear operate with two channels and are failsafe, as they have two safety contact paths. The combination and arrangement of the reed-tube in the sensor has the consequence that the sensor cannot be actuated with a conventional magnet, but only with the associated target. With this type of encoding a good protection against manipulation is ensured.

The BNS-sensors are compact and achieve high reacting distances. The sensors also act through plastic and stainless steel covers allowing a hidden installation. The user is on a wide program of different designs. The special features include sensors with stainless steel housing.

The magnetic-principle of the safety-oriented detectors of actuators is now being used with the safety door monitoring in integrated systems. The BNS-B20 series is an available system where the magnetic sensor is combined with the door handle and also includes the locking mechanism.

6. SAFETY SENSORS DESCRIPTION

ELECTRONIC SAFETY SENSORS CSS

As an alternative to the BNS - series is the electronic safety sensors of the CSS-series. Instead of the magnetic principle the Schmersal developed bi-directional "Coded Safety Sensor Technology (CSS) is used; this is based on the pulse-echo technique.

This principle makes very fast reactions possible. The CSS safety sensors are characterised by exact switching points and high noise immunity. The microprocessor technology enables the serial connection of up to 31 sensors on a common signal line in the "daisy chain" principle and their evaluation over a single safety relay component.

The integrated electronics allow intelligent diagnostics, as well as simple and fast fault determination, such as with a cross-connection or a wiring fault. These non-safety-related signals can also be interfaced with the help of a SD interface with up to 31 integrated sensors and can be used with all common field bus protocols to transfer to a central control system.

Safety sensors of the CSS-series are available in cylindrical and rectangular form. The program also includes the CSS 34 F with integrated feedback circuit monitoring, which can be used without any additional safety relay module.



ELECTRONIC SAFETY SENSORS RSS

The safety sensors of the RSS-series are the most recent enlargement in the range of the electronic safety sensors for the Schmersal Group. The Schmersal developers successfully created a product using the RFID technology for safety oriented applications, which is frequently used in the industry.

The RFID-technology offers the advantage that the user can select from different types of coding. The basic version accepts any suitable target. A second version only accepts the actuator for which the teach-in process was run during initial activation (I1 variant). A third version is now also available which responds to an individually-assigned actuator only. This kind of teach-in process can be repeated any number of times (I2-variant).

This means that for individually-coded variants I1 and I2 the coding level "high" is fulfilled in accordance with EN ISO 14119, thereby ensuring a high level of manipulation protection for doors which are at particular risk of interference.

6. SAFETY SENSORS

BNS – RECTANGULAR DESIGN – OVERVIEW OF THE SERIES



Key Features

<ul style="list-style-type: none"> Extremely compact design Max. 3 contacts Thermoplastic enclosure 	<ul style="list-style-type: none"> Extremely compact design Max. 3 contacts Thermoplastic enclosure 	<ul style="list-style-type: none"> Suitable for food processing industry Max. 3 contacts Stainless steel enclosure
--	--	---

Other versions

ATEX / IECEx	■	-	■
AS-i SaW (see page 258)	-	■	-

Technical features

Electrical characteristics			
Assured switching distance s_{ao}	4 mm	5 mm	8 mm
Assured switch-off distance s_{ar}	14 mm	15 mm	18 mm
Switching voltage	without LED	max. 24 VDC	max. 75 VDC
	with LED	max. 24 VDC	max. 24 VDC
Switching current	without LED	max. 100 mA	max. 400 mA
	with LED	max. 10 mA	max. 10 mA
Switching capacity	without LED	max. 1 W	max. 10 VA
	with LED	max. 240 mW	max. 240 mW
Mechanical data			
Magnetic coding	■	■	■
Integr. evaluation	-	-	-
Termination	Cable	Cable or connector plug	Cable or cable connector
Cable section	4 x 0.25 mm ² ; -2187: 6 x 0.25 mm ²	4 x 0.25 mm ² ; -/01: 6 x 0.25 mm ²	6 x 0.25 mm ²
Dimensions (W x D x H)	33 x 13 x 25 mm	36 x 13 x 26 mm	88 x 14.5 x 27 mm
LED switching conditions display	-	■	■
Ambient conditions			
Ambient temperature	-25 °C ... +70 °C	-25 °C ... +70 °C	-25 °C ... +80 °C
Degree of protection	IP67	IP67	IP69K

Safety classification

Standards	EN ISO 13849-1	EN ISO 13849-1	EN ISO 13849-1
B ₁₀₀ (NC / NO contact)	25,000,000	25,000,000	25,000,000
Certificates	BG, cULus, EAC	BG, cULus, EAC	BG, cULus, EAC



To get detailed information about the products and certificates, visit products.schmersal.com.



■ BNS 36

■ BNS 16

- High switching distance and offset possible
- Max. 3 contacts
- Thermoplastic enclosure

- Different approach possibilities
- Max. 3 contacts
- Thermoplastic enclosure

–

■

–

■

7 mm;
10 mm (-2750)

17 mm;
20 mm (-2750)

max. 75 VDC

max. 24 VDC

max. 30 VDC

max. 400 mA

max. 10 mA

max. 10 VA

max. 240 mW

■

–

Cable or
connector plug
4 x 0.25 mm²;
-/01: 6 x 0.25 mm²

88 x 13 x 25 mm

■

–25 °C ... +70 °C

IP67

8 mm

18 mm

max. 100 VAC/DC

–

–

max. 400 mA

–

max. 10 W

–

■

–

Screw terminal or
connector plug
2 x 1.5 mm²

55 x 39.5 x 93 mm

–

–25 °C ... +70 °C

IP67

EN ISO 13849-1

25,000,000

BG, cULus, EAC

EN ISO 13849-1

25,000,000

BG, cULus, EAC













6. SAFETY SENSORS

BNS – RECTANGULAR DESIGN – PREFERRED TYPES

Range	Design	Housing material	Sao/Sar	Actuator	Integr. evaluation	Contacts
BNS 250		Plastic	4 / 14	BPS 250		1 NO / 1 NC
						1 NO / 2 NC
BNS 260		Plastic	5 / 15	BPS 260-1 BPS 260-2		1 NO / 1 NC
						1 NO / 1 NC + signalling contact 1 NC
						2 NC
						2 NC + signalling contact 1 NC
BNS 40S		Stainless steel	8 / 18	BPS 40S-1 BPS 40S-2 BPS 40S-1-C BPS 40S-2-C		1 NO / 2 NC
BNS 16		Plastic	8 / 18	BPS 16		1 NO / 2 NC
BNS 36		Plastic	7 / 17	BPS 36-1 BPS 36-2		2 NC
						2 NC + signalling contact 1 NC
						1 NO / 1 NC
						1 NO / 1 NC + signalling contact 1 NC

Actuators should be ordered separately. A selection can be found on page 128.

Information for the selection of suitable safety relay modules can be found in the chapter "Safety relay modules" (refer to page 220).

Termination	LED available	Description	Type	Material number	
Cable	■	---	BNS 250-11Z	101120670	
			BNS 250-11ZG	101120671	
	BNS 250-12Z		101123071		
	BNS 250-12ZG		101123072		
Cable			BNS 260-11Z-L	101184387	
			BNS 260-11Z-R	101184371	
Connector plug	■		BNS 260-11Z-ST-L	101184379	
			BNS 260-11Z-ST-R	101184363	
			BNS 260-11ZG-ST-L	101184383	
	■		BNS 260-11ZG-ST-R	101184367	
			BNS 260-11/01Z-ST-R	101184364	
			BNS 260-11/01ZG-ST-L	101184384	
Cable			BNS 260-02Z-ST-L	101184377	
			BNS 260-02ZG-ST-R	101184365	
Connector plug			BNS 260-02/01Z-L	101184386	
			BNS 260-02/01Z-ST-R	101184362	
Cable	■	Continuous threaded holes	BNS 40S-12Z	101215517	
			BNS 40S-12ZG	101215516	
	■	Hidden, rear-side threads	BNS 40S-12Z-C	101215518	
			BNS 40S-12ZG-C	101215515	
Cable connector			BNS-12ZG-C-LST 0.3M	103014357	
Screw connection			Actuating planes cover-side	BNS 16-12ZD	101172563
			Actuating planes left-hand side	BNS 16-12ZL	101172554
			Actuating planes right-hand side	BNS 16-12ZR	101172556
			Actuating planes bottom	BNS 16-12ZU	101172565
			Actuating planes front side	BNS 16-12ZV	101172553
Cable	■		BNS 36-02Z-R	101193132	
			BNS 36-02ZG-R	101190050	
Connector plug	■		BNS 36-02Z-ST-L	101193156	
			BNS 36-02ZG-ST-R	101193168	
			BNS 36-02/01Z-ST-L	101193249	
			BNS 36-02/01Z-ST-R	101190024	
Cable	■		BNS 36-11Z-L	101193125	
			BNS 36-11ZG-R	101193143	
Connector plug	■		BNS 36-11Z-ST-L	101193148	
			BNS 36-11ZG-ST-R	101193158	
Cable	■		BNS 36-11/01Z-R	101190042	
			BNS 36-11/01ZG-R	101193177	
Connector plug	■		BNS 36-11/01Z-ST-L	101193236	
			BNS 36-11/01ZG-ST-R	101193254	



Line and connector outlet on the right



Line and connector outlet on the left

6. SAFETY SENSORS

BNS – CYLINDRICAL AND MISCELLANEOUS DESIGN – OVERVIEW OF THE SERIES



Key Features

- | | | |
|--|--|--|
| <ul style="list-style-type: none"> ▪ Cylindrical design M12 ▪ Max. 3 contacts ▪ Thermoplastic enclosure | <ul style="list-style-type: none"> ▪ Cylindrical design M18 ▪ Max. 3 contacts ▪ Thermoplastic enclosure | <ul style="list-style-type: none"> ▪ Cylindrical design M30 ▪ Max. 3 contacts ▪ Thermoplastic enclosure |
|--|--|--|

Other versions

ATEX / IECEx	■	■	■
AS-i SaW (see page 258)	-	-	-

Technical features

Electrical characteristics			
Assured switching distance s_{ao}	10 mm (BP 6/BP 8); 20 mm (BP 10/15 SS)	10 mm (BP 6/BP 8); 20 mm (BP 10/15 SS)	5 mm; 8 mm (-2211)
Assured switch-off distance s_{ar}	22 mm (BP 6/BP 8); 32 mm (BP 10/15 SS)	22 mm (BP 6/BP 8); 32 mm (BP 10/15 SS)	15 mm; 18 mm (-2211)
Switching voltage	without LED	max. 100 VAC/DC	max. 100 VAC/DC
	with LED	-	max. 24 VDC
	with connector	-	max. 100 VAC/DC
Switching current	without LED	max. 250 mA	max. 400 mA
	with LED	-	max. 10 mA
	ordering suffix -03Z	-	max. 250 mA
Switching capacity	without LED	-02z: max. 3 W; -11z, -12z: max. 5 W	-02z: max. 3 W; -11z, -12z: max. 5 W
	with LED	-	max. 240 mW
Mechanical data			
Magnetic coding	-	-	■
Integr. evaluation	-	-	-
Termination	Cable	Cable	Cable or connector plug
Cable section	4 x 0.25 mm ²	4 x 0.25 mm ²	4 x 0.25 mm ²
Dimensions (W x D x H)	M12 x 38.5 mm	M18 x 36 mm	M30 x 44 mm
Mounting hole	M12	M18	M30
LED switching conditions display	-	-	■
Ambient conditions			
Ambient temperature	-25 °C ... +70 °C	-25 °C ... +70 °C	-25 °C ... +70 °C
Degree of protection	IP67	IP67	IP67

Safety classification

Standards	EN ISO 13849-1	EN ISO 13849-1	EN ISO 13849-1
B ₁₀₀ (NC / NO contact)	25,000,000	25,000,000	25,000,000
Certificates	BG, cULus, EAC	BG, cULus, EAC	BG, cULus, EAC

To get detailed information about the products and certificates, visit products.schmersal.com.





■ BNS 300



■ BNS 30



■ BNS-B20

- Cylindrical design M30
- Integrated evaluation
- 1 contact
- Thermoplastic enclosure

- Cylindrical design M30
- Integrated evaluation
- 1 contact
- Metal enclosure

- Door handle actuator
- Latching force approx. 100 N
- Max. 3 contacts
- Thermoplastic enclosure

-	-	-
-	-	-







5 mm; 8 mm (-2211)	5 mm; 8 mm (-2211, -2334)	0 mm
15 mm; 18 mm (-2211)	15 mm; 18 mm (-2211, -2334)	22 mm
max. 250 VAC	max. 250 VAC	max. 110 VAC/DC
-	max. 250 VAC	max. 24 VDC
-	-	max. 24 VDC
max. 3 A	max. 3 A	max. 250 mA
-	max. 3 A	max. 10 mA
-	-	-
max. 750 W	max. 750 W	max. 3 W
-	max. 750 W	max. 240 mW
■	■	■
■	■	-
Cable or connector plug	Cable or connector plug	Cable or connector plug
4 x 0.75 mm ²	4 x 0.75 mm ²	6 x 0.25 mm ²
M30 x 78 mm	M30 x 78 mm	119.5 x 43.3 x 140 mm
M30	M30	-
■	■	■
-25 °C ... +55 °C	-25 °C ... +55 °C	-25 °C ... +70 °C
IP67	IP67	IP67

EN ISO 13849-1 ¹⁾	EN ISO 13849-1 ¹⁾	EN ISO 13849-1
20,000,000	20,000,000	25,000,000
BG, cULus, EAC	BG, cULus	BG, cULus, EAC

¹⁾ Performance Level: PL c

6. SAFETY SENSORS

BNS – CYLINDRICAL AND MISCELLANEOUS DESIGN – PREFERRED TYPES

Range	Design	Housing material	Sao/Sar	Actuator	Integr. evaluation	Contacts
BNS 120		Plastic	10 / 22 mm	BP 6 / BP 8 BP 10/15SS		2 NC
			20 / 32 mm			1 NO / 1 NC
BNS 180		Plastic	10 / 22 mm	BP 6 / BP 8 BP 10/15SS		2 NC
			20 / 32 mm			1 NO / 1 NC
BNS 303		Plastic	5 / 15 mm	BPS 300 BPS 303 BPS 303SS		1 NO / 1 NC
			8 / 18 mm			
BNS 300		Plastic	5 / 15 mm	BPS 300 BPS 303 BPS 303SS	■	1 NC
			8 / 18 mm			
BNS 30		Metal	8 / 18 mm	BPS 300 BPS 303 BPS 303SS	■	1 NC
BNS-B20		Plastic	0 / 22 mm	BNS-B20-B01		1 NO / 2 NC

Actuators should be ordered separately. A selection can be found on page 128.

Information for the selection of suitable safety relay modules can be found in the chapter "Safety relay modules" (refer to page 220).

	Termination	LED available	Description	Type	Material number
	Cable		---	BNS 120-02Z	101144422
				BNS 120-11Z	101128296
	Cable		---	BNS 180-02Z	101133009
				BNS 180-11Z	101120933
	Cable		---	BNS 303-11Z	101115682
				BNS 303-11ZG	101138262
	Connector plug	■	---	BNS 303-11ZG-ST	101174794
				BNS 303-11ZG-ST-2211	101194346
	Cable	■	---	BNS 300-01ZG	101110514
				BNS 300-01ZG-ST	101144214
	Connector plug	■	---	BNS 300-01ZG-ST-2211	101186264
				BNS 30-01ZG-2211	101166315
	Cable	■	Higher switching distance	BNS 30-01Z-ST-2211	101181851
	Connector plug				
	Cable		Door hinge on the right-hand side	BNS-B20-12Z-R	101186267
			Door hinge on the left-hand side	BNS-B20-12Z-ST-L	101186261
	Connector plug	■	Door hinge on the right-hand side	BNS-B20-12Z-ST-R	101186260
			Door hinge on the left-hand side	BNS-B20-12ZG-ST-L	101177733
			Door hinge on the right-hand side	BNS-B20-12ZG-ST-R	101177734

6. SAFETY SENSORS

BNS – ACTUATORS AND ACCESSORIES

BPS 250	101120594	SPACER BNS 250	101131223	BPS 260-
 <ul style="list-style-type: none"> ■ Actuator for BNS 250 ■ Thermoplastic enclosure 	 <ul style="list-style-type: none"> ■ Thermoplastic enclosure ■ To mount the magnetic safety sensor and actuator on ferromagnetic material 	 <ul style="list-style-type: none"> ■ Actuator and sensor on a mounting level: BPS 260-1 101184395 ■ Actuator 90° attached to the sensor: BPS 260-2 101184396 		
SPACER BNS 260	101184643	BPS 40S-	BPS 40S--C	
 <ul style="list-style-type: none"> ■ Thermoplastic enclosure ■ To mount the magnetic safety sensor and actuator on ferromagnetic material 	 <ul style="list-style-type: none"> ■ Actuator for BNS 40S ■ Actuator and sensor on a mounting level: BPS 40S-1 101215268 ■ Actuator 90° attached to the sensor: BPS 40S-2 101215269 	 <ul style="list-style-type: none"> ■ Actuator for BNS 40S--...-C ■ Actuator and sensor on a mounting level: BPS 40S-1-C 101215266 ■ Actuator 90° attached to the sensor: BPS 40S-2-C 101215267 		
BPS 16	101172566	BPS 36-	SPACER BNS 36	101188624
 <ul style="list-style-type: none"> ■ Actuator for BNS 16 ■ Thermoplastic enclosure 	 <ul style="list-style-type: none"> ■ Actuator and sensor on a mounting level: BPS 36-1 101190052 ■ Actuator 90° attached to the sensor: BPS 36-2 101191859 	 <ul style="list-style-type: none"> ■ Thermoplastic enclosure ■ To mount the magnetic safety sensor and actuator on ferromagnetic material 		

Detailed information for the selection of actuators and accessories can be found at products.schmersal.com.

6. SAFETY SENSORS

BNS – ACTUATORS AND ACCESSORIES

<p>BP 6 101091837</p>  <ul style="list-style-type: none"> ■ Actuator, unenclosed ■ S-pole marked red ■ Not coded 	<p>BP 8 101054816</p>  <ul style="list-style-type: none"> ■ Actuator, unenclosed ■ S-pole marked red ■ Not coded 	<p>BP 10 101057531</p>  <ul style="list-style-type: none"> ■ Actuator, unenclosed ■ Colour coding of poles by labels ■ Not coded
<p>BP 15 SS 101139818</p>  <ul style="list-style-type: none"> ■ Actuator, stainless steel ■ Suitable for food processing industry ■ Not coded 	<p>BPS 300 101113734</p>  <ul style="list-style-type: none"> ■ Actuator, with plastic enclosure 	<p>BPS 300 S 103042545</p>  <ul style="list-style-type: none"> ■ Actuator, stainless steel ■ Suitable for food processing industry
<p>BPS 303 101117076</p>  <ul style="list-style-type: none"> ■ Actuator, with plastic enclosure ■ Suitable for food processing industry 	<p>BPS 303 SS 101141156</p>  <ul style="list-style-type: none"> ■ Actuator, stainless steel ■ Suitable for food processing industry 	<p>BNS-B20-B01 101177737</p>  <ul style="list-style-type: none"> ■ Actuator for BNS-B20 ■ Order the door handle actuator separately. ■ Thermoplastic enclosure

Detailed information for the selection of actuators and accessories can be found at products.schmersal.com.

6. SAFETY SENSORS

RSS/CSS – OVERVIEW OF THE SERIES



■ RSS 16



■ RSS 36



■ CSS 30

Key Features

- Three actuating directions
- Door stop with magnetic latching
- Thermoplastic enclosure

- As end stop with magnetic latching
- Thermoplastic enclosure

- High switching distance
- Cylindrical design M30
- Metal enclosure

Other versions

ATEX / IECEx	–	–	–
AS-i SaW (see page 258)	–	■	–

Technical features

Electrical characteristics			
Assured switching distance s_{ao}	12 mm, with latching: 5 mm	10 mm	CST 30-1: 12 mm; CST 34-S-3: 10 mm
Assured switch-off distance s_{ar}	30 mm	20 mm	CST 30-1: 19 mm; CST 34-S-3: 16 mm
Number of outputs	2x OSSD, 1x Diagnostic	2x OSSD, 1x Diagnostic	2x OSSD, 1x Diagnostic
Operating voltage	24 VDC (PELV)	24 VDC (PELV)	24 VDC (PELV)
Operating current	< 0.1 A without load	< 0,1 A without load	< 0,1 A without load
Max. switching capacity U/I	24 VDC / 1 A	24 VDC / 250 mA	24 VDC / 500 mA
Mechanical data			
Individual coding possible	■	■	–
Serial diagnostics	■	■	–
Termination	Connector plug, cage clamps, screw terminals	Connector plug	Cable
Cable section	–	–	0.25 mm ²
Dimensions (W x D x H)	52 x 91 x 30 mm	106 x 25 x 22.6 mm	Ø M30
LED switching conditions display	■	■	■
Ambient conditions			
Ambient temperature	–25 °C ... +70 °C	–25 °C ... +70 °C	–25 °C ... max. +70 °C
Degree of protection	IP65 / IP66 / IP67	IP65 / IP67 / IP69	IP65 / IP67

Safety classification

Standards	EN ISO 13849-1, IEC 61508, EN 62061	EN ISO 13849-1, IEC 61508, EN 62061	EN ISO 13849-1, IEC 61508
PL/SIL ¹⁾	e/3	e/3	e/3
Category ¹⁾	4	4	4
PFH	6.3 x 10 ⁻¹¹ /h	2.7 x 10 ⁻¹⁰ /h	2.5 x 10 ⁻⁹ /h
Certificates	TÜV, cULus, EAC	TÜV, cULus, EAC	BG, cULus, EAC



To get detailed information about the products and certificates, visit products.schmersal.com.



■ CSS 30S



■ CSS 300



■ CSS 34



■ CSS 180

- Functions through stainless steel
- Cylindrical design M30
- Stainless steel enclosure

- Functions through stainless steel
- Cylindrical design M30
- Thermoplastic enclosure

- CSS 34 F with integrated feedback-loop monitoring saves on safety evaluation
- Thermoplastic enclosure

- Cylindrical design M18
- Thermoplastic enclosure

-	-	-	■
-	-	-	-

8 mm	8 mm	depending on the actuator, see table page 136	7 mm
15 mm	15 mm	depending on the actuator, see table page 136	10 mm
2x OSSD, 1x Diagnostic 24 VDC (PELV) < 0,1 A without load 24 VDC / 250 mA	2x OSSD, 1x Diagnostic 24 VDC (PELV) < 0,1 A without load 24 VDC / 250 mA	2x OSSD, 1x Diagnostic 24 VDC (PELV) < 0,1 A without load 24 VDC / 250 mA	2x OSSD, 1x Diagnostic 24 VDC (PELV) < 0,1 A without load 24 VDC / 500 mA
-	-	-	-
■	■	■	-
Connector plug	Connector plug	Cable or connector plug	Cable or cable with connector plug or connector plug
-	-	0.35 mm ²	0.25 ... 0.5 mm ²
Ø M30	Ø M30	27 x 108.2 x 35 mm	Ø M18
■	■	■	■
-25 °C ... +65 °C IP65 / IP67 / IP68; IP69	-25 °C ... +60 °C IP65 / IP67	-25 °C ... max. +70 °C IP65 / IP67	-25 °C ... max. +70 °C IP65 / IP67

EN ISO 13849-1, IEC 61508	EN ISO 13849-1, IEC 61508	EN ISO 13849-1, IEC 61508	EN ISO 13849-1, IEC 61508
e/3	e/3	e/3	e/3
4	4	4	4
3.6 x 10 ⁻⁹ /h TÜV, cULus, EAC	3.6 x 10 ⁻⁹ /h TÜV, cULus, EAC	3.6 x 10 ⁻⁹ /h BG, cULus, EAC	2.5 x 10 ⁻⁹ /h BG, cULus, EAC

¹⁾ Also with series-wiring.

6. SAFETY SENSORS

RSS/CSS – PREFERRED TYPES

Range	Design	Housing material	Sao/Sar	Actuator	Actuation direction
RSS 16		Plastic	12 / 30	RST-16-1 RST 16-1-R RST-U-2	From head From top From below
RSS 36		Plastic	10 / 20	RST 36-1 RST 36-1-R RST 16-1 RST-U-2	From side
CSS 30		Metal film	12 / 19	CST 30-1 CST 34-S-3	From head
CSS 30S		Metal film	8 / 15	CST 30S-1	
CSS 300		Plastic	8 / 15	CST 30S-1	
CSS 34		Plastic	depending on the actuator, see table page 136	CST 180-1 CST 180-2 CST 34-V-1 CST 34-S-1 CST 34-S-2 CST 34-S-3	From head From side
CSS 180		Plastic	7 / 10	CST 180-1 CST 180-2	From head

Actuators should be ordered separately. A selection can be found on page 134.

Safety output	Diagnostic	Termination	Type	Material number		
2 p-type, short-circuit proof safety outputs	Conventional	Connector plug	RSS16-D-R-ST8H	103004338		
			RSS16-D-ST8H	103004370		
			RSS16-I2-D-R-ST8H	103004367		
			RSS16-SD-ST8H	103006685		
	Serial	Cage clamps	RSS16-D-CC	103004372		
			RSS16-D-R-CC	103004365		
			Screw Terminals	RSS16-D-R-SK	103004341	
2 p-type, short-circuit proof safety outputs	Conventional	Connector plug	RSS 36-D-ST	101213954		
			RSS 36-I1-D-R-ST	101216957		
			RSS 36-I1-D-ST	101216958		
			RSS 36-I2-D-R-ST	101214773		
			RSS 36-I2-D-ST	101216956		
	Serial		RSS 36-SD-ST	101214772		
	2 p-type, short-circuit proof safety outputs	Conventional	Cable ¹⁾	CSS 15-30-2P+D-M-L	101209841	
Serial		Connector plug	CSS 11-30S-D-M-ST	101204612		
			CSS 11-30S-SD-M-ST	101204613		
Conventional		Connector plug	CSS 11-300-D-M-ST	101213904		
Serial			CSS 11-300-SD-M-ST	101213905		
2 p-type, short-circuit proof safety outputs	Conventional	Cable ¹⁾	CSS 12-34-V-D-M-L	101181060		
		Connector plug	CSS 12-34-V-D-M-ST	101181065		
	Serial	Cable ¹⁾	CSS 12-34-V-SD-M-L	101181062		
			CSS 12-34-V-SD-M-ST	101181067		
	Conventional	Connector plug	CSS 12-34F0-V-D-M-ST	101189088		
			CSS 12-34F1-V-D-M-ST	101188768		
			Cable ¹⁾	CSS 14-34-S-D-M-L	101181059	
	Conventional	Connector plug	CSS 14-34-S-D-M-ST	101181063		
			Cable ¹⁾	CSS 14-34-S-SD-M-L	101181061	
	Serial		CSS 14-34-S-SD-M-ST	101181066		
			Conventional	Connector plug	CSS 14-34F0-S-D-M-ST	101188767
		CSS 14-34F1-S-D-M-ST	101189087			
	2 p-type, short-circuit proof safety outputs	Without	Cable ¹⁾	CSS 8-180-2P-E-L	101167896	
Cable ¹⁾ with connector			CSS 8-180-2P-E-LST	101167897		
Cable ¹⁾			CSS 8-180-2P-Y-L	101165294		
Cable ¹⁾ with connector			CSS 8-180-2P-Y-LST	101167898		
Conventional		Connector plug	Cable ¹⁾	CSS 8-180-2P+D-E-L	101169552	
			Cable ¹⁾ with connector	CSS 8-180-2P+D-E-LST	101169553	
			Cable ¹⁾	CSS 8-180-2P+D-M-L	101169558	
			Cable ¹⁾ with connector	CSS 8-180-2P+D-M-LST	101169560	
					CSS 8-180-2P+D-M-ST	101209595

¹⁾ Standard cable length 2 m; other lengths upon request.

6. SAFETY SENSORS

RSS/CSS – ACTUATORS AND ACCESSORIES

RST 16-1	103004336	RST16-1-R	103004337	RST 36-	
					
<ul style="list-style-type: none"> ■ Flat actuator for RSS 16, RSS 36 and RSS 260 ■ Thermoplastic enclosure 		<ul style="list-style-type: none"> ■ Actuator with latching function for RSS 16-...-R ■ Plastic and stainless steel enclosure 		<ul style="list-style-type: none"> ■ Actuator for RSS 36 RST 36-1 ■ Actuator with latching magnet: RST 36-1-R 	<p>101213820</p> <p>101213821</p>
ACC RSS 36-SK	101215048	RST 260-1	103004318	RST-U-2	103005994
					
<ul style="list-style-type: none"> ■ Sealing kit for RSS 36 ■ To seal the mounting holes and as spacer 		<ul style="list-style-type: none"> ■ Actuator for RSS 260 ■ Thermoplastic enclosure 		<ul style="list-style-type: none"> ■ Small actuator for RSS 16, RSS 36 and RSS 260 ■ Thermoplastic enclosure 	
CST 34-S-1	101181085	CST 34-S-2	101196101	CST 34-V-1	101181429
					
<ul style="list-style-type: none"> ■ Actuator for CSS 34 ■ Thermoplastic enclosure ■ Lateral active surface (type plate) 		<ul style="list-style-type: none"> ■ Actuator for CSS 34 ■ Thermoplastic enclosure ■ Actuator with double solenoid, for increased misalignment ■ Lateral active surface (type plate) 		<ul style="list-style-type: none"> ■ Actuator for CSS 34 ■ Thermoplastic enclosure ■ Frontal active surface (blue clamp) 	

Detailed information for the selection of actuators and accessories can be found at products.schmersal.com.

6. SAFETY SENSORS













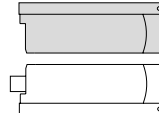
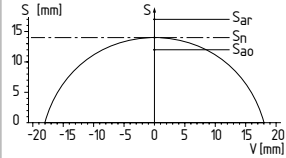

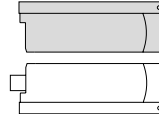
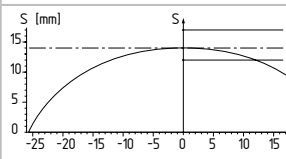

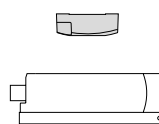
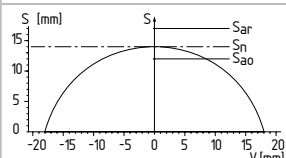
RSS/CSS – ACTUATORS AND ACCESSORIES

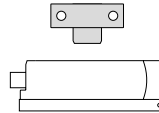
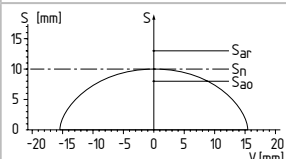
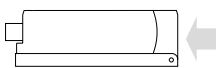
CST 34-S-3	101203434	CST 30-1	101209887	CST 30S-1	101193607
 <ul style="list-style-type: none"> ■ Small actuator for CSS 34 and CSS 30 ■ Thermoplastic enclosure 		 <ul style="list-style-type: none"> ■ Actuator for CSS 30 ■ Thermoplastic enclosure M30 		 <ul style="list-style-type: none"> ■ Actuator for CSS 30S and CSS 300 ■ Stainless steel enclosure M30 	
CST 180-1	101177198	CST 180-2	101179574		
 <ul style="list-style-type: none"> ■ Actuator for CSS 180 and CSS 34 ■ Plastic housing with cross borehole ■ Incl. H18 clamp 		 <ul style="list-style-type: none"> ■ Actuator for CSS 180 and CSS 34 ■ Thermoplastic enclosure M18 ■ Without clamp 			
CSA-M-1	101173457	H 30	101068520	H 18	101068879
 <ul style="list-style-type: none"> ■ Magnetic snap lock ■ For play-free interlocking of light guards 		 <ul style="list-style-type: none"> ■ Clamp for CSS 30, 30S and 300 ■ For a smooth fitting of the safety sensors with cylindrical shape Ø 30 		 <ul style="list-style-type: none"> ■ Clamp for CSS 180 ■ For a smooth fitting of the safety sensors with cylindrical shape Ø 18 	

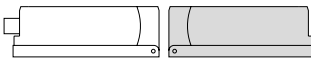
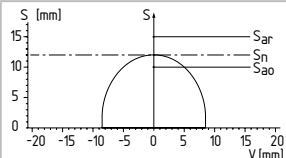
Detailed information for the selection of actuators and accessories can be found at products.schmersal.com.

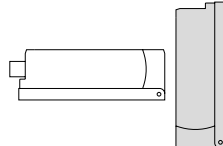
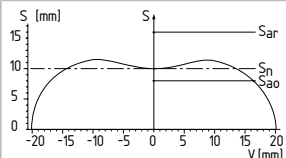
6. SAFETY SENSORS

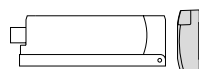
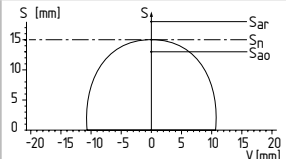
CSS 34 – ACTUATOR-OVERVIEW

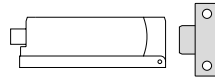
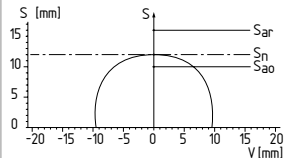
Safety sensor	Actuator	Actuation	Switching distances to EN 62061-5-3
<p>Lateral actuation</p>  <p>CSS 14-34-S ...</p>	CST 34-S-1 		S_n 14 mm S_{ao} 12 mm S_{ar} 17 mm 
	CST 34-S-2 		S_n 14 mm S_{ao} 12 mm S_{ar} 17 mm 
	CST 34-S-3 		S_n 14 mm S_{ao} 12 mm S_{ar} 17 mm 
	CST 180-1 / CST 180-2 		S_n 10 mm S_{ao} 8 mm S_{ar} 13 mm 
<p>Actuation from front</p>  <p>CSS 12-34-V ...</p>	CST 34-V-1 		S_n 12 mm S_{ao} 10 mm S_{ar} 15 mm 
	CST 34-S-2 		S_n 10 mm S_{ao} 8 mm S_{ar} 16 mm 
	CST 34-S-3 		S_n 15 mm S_{ao} 13 mm S_{ar} 18 mm 
	CST 180-1 / CST 180-2 		S_n 12 mm S_{ao} 10 mm S_{ar} 16 mm 

UP-TO-DATE WITHOUT FAIL THE SCHMERSAL WEBSHOP

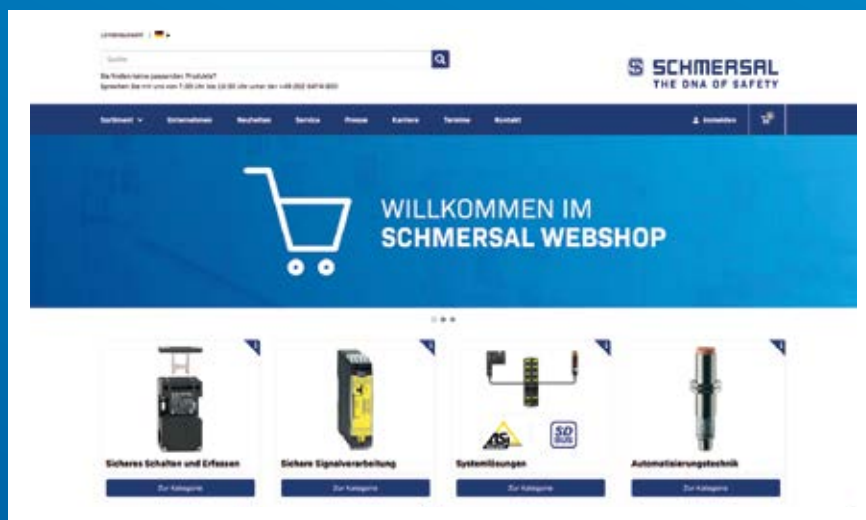

FOR DETAILED INFORMATION, CHECK OUT
[PRODUCTS.SCHMERSAL.COM](https://products.schmersal.com)

7. PULL-WIRE EMERGENCY STOP SWITCHES

DESCRIPTION

AREA OF APPLICATION

Pull-wire emergency switches are used on machinery and equipment that cannot be protected by safety covers or safety doors.

Their main area of application are transport and conveyor systems. But also for large equipment such as in the recycling industry, plastics and wood processing is this type of safety switchgear widely used.

The reason for this is: In contrast to the EMERGENCY STOP mushroom pushbutton, the pull-wire emergency switch can trigger the EMERGENCY STOP function at any point along the rope. This is an important safety feature in the event of a hazard.

In conjunction with an appropriate safety analysis, a pull-wire emergency stop switch can be used up to PL e according to EN ISO 13849-1. Information for the selection of suitable safety relay modules can be found in the chapter "Safety relay modules" (refer to page 220).

Included in the range of pull-wire switches of the Schmersal Group are variants with integrated AS-i SaW (AS-Interface Safety at Work) or DuplineSafe® interface. Both systems have the advantage of standardised and trusted bus systems.

With the right design, they can also be used in explosively hazardous areas and under extreme temperatures.

DESIGN AND WAY OF FUNCTIONING

All pull-wire emergency switches from the Schmersal Group are in accordance with the guidelines of the EN 60947-5-1, EN ISO 13850 and EN 620. A wire and wire-breakage monitoring is standard equipment.

The pull-wire emergency switch is set in the operating condition by pre-tensioning the rope. Then the NC contacts are closed and the NO contacts are open. If the rope is pulled or broken the NC contacts are opened and the NO contacts closed. Thereafter the pull-wire emergency switch can only be manually set back into an operational state.

A distinction is made between one-sided and two-sided acting pull-wire emergency switches. While one-sided series are installed on one side of the system, the assembly of the two-sided pull-wire emergency switch is centrally located. In addition to the assembly possibilities, the rope length and the number of available contacts is important with the selection.



MOUNTING INSTRUCTIONS

One-side acting pull-wire emergency switch (example ZQ 900)

The pull-wire emergency switch with one-sided action is installed at either the start or the end of the hazardous area. The rope is fastened accordingly to the opposite end.

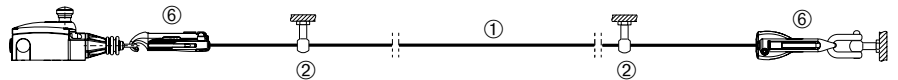

Two-side acting pull-wire emergency switch (example RS655, RS656)

The pull-wire emergency switch with two-side actuation is mounted mid-way, so that the rope can be clamped on both sides. Depending on the pulling direction, the actuating lever is swung to the left or right, thus triggering the EMERGENCY STOP command.

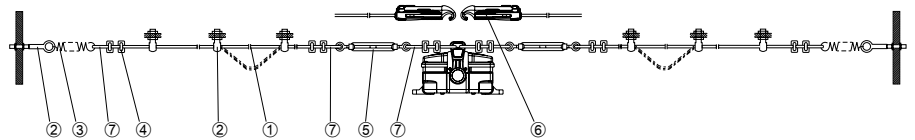

Key

- ① Wire rope
- ② Eyebolt / Anchoring hook
- ③ Tension spring
- ④ Wire clamp
- ⑤ Tensioning Jack
- ⑥ Rope tensioner
- ⑦ Wire thimble

7. PULL-WIRE EMERGENCY STOP SWITCHES OVERVIEW OF THE SERIES



RS



ZQ 700



ZQ 900

Key Features

- Maximum cable length 2 x 100 m
- Wire pull and wire breakage detection
- 2 NO contacts / 2 NC contacts
- Symmetry thanks to centrally located shaft
- Central connection terminal
- Mechanical switching position indication

- Maximum cable length 10 m
- Wire pull and wire breakage detection
- 2 contacts
- Plastic enclosure, thermoplastic

- Maximum cable length 75 m
- Wire pull and wire breakage detection
- 4 contacts
- Enclosure in zinc die-cast and thermoplastic

Other versions

	RS	ZQ 700	ZQ 900
ATEX / IECEx	■	-	■
Connector variant for safety fieldbox (SFB)	-	■	-
DuplineSafe®	■	-	-

Technical features

Electrical characteristics	RS	ZQ 700	ZQ 900
Max. switching capacity U/I	230 VAC / 3 A; 24 VDC / 3 A	230 VAC / 4 A; 24 VDC / 4 A	230 VAC / 4 A; 24 VDC / 1 A
Mechanical data			
Cable entry	2 x M25	1 x M20	3 x M20
Cable section ¹⁾	0.5 ... 2.5 mm ² (central connection terminal)	0.75 ... 2.5 mm ²	0.75 ... 2.5 mm ²
Dimensions (W x H x D)	234 x 108 x 119 mm	40.5 x 160 x 51 mm	71 x 220 x 69.7 mm
Ambient conditions			
Ambient temperature	-40 °C ... +70 °C	-25 °C ... +70 °C	-25 °C ... +70 °C
Degree of protection	IP66, IP67	IP67	IP67

Safety classification

Standards	RS	ZQ 700	ZQ 900
B ₁₀₀ NC contact	100,000	100,000	100,000
Certificates	cULus, CCC, EAC, TÜV	cULus, CCC, EAC, TÜV	cULus, CCC, EAC, TÜV



¹⁾ Including conductor ferrules.



To get detailed information about the products and certificates, visit products.schmersal.com.

7. PULL-WIRE EMERGENCY STOP SWITCHES PREFERRED TYPES



Range	Enclosure	Operating principle	Possible wire length	Emergency stop button	Unlocking	Contacts	Indicator lamp	Type designation	Material number
RS655 RS656 	Grey cast iron, painted	2-side operation	2 x 100 m		RESET button	2 NO / 2 NC	---	RS655-Z22	153031612
							red, 24 VDC	RS655-Z22-G024	153031614
							red, 115 VDC	RS655-Z22-G115	153031644
							red, 230 VDC	RS655-Z22-G230	153031616
							---	RS655-Z22-DS*	153031618
	Thermosetting resin						---	RS656-Z22	153031613
							red, 24 VDC	RS656-Z22-G024	153031615
							red, 115 VDC	RS656-Z22-G115	153031645
							red, 230 VDC	RS656-Z22-G230	153031617
---	RS656-Z22-DS*	153031619							
ZQ 700 	Plastic	1-side operation	10 m		Key button	2 NC	---	ZQ 700-02	101192478
						1 NO / 1 NC		ZQ 700-11	101192476
ZQ 900 	Metal / Plastic	1-side operation	75 m		Key button	2 NC	optionally as accessories	ZQ 900-02	101186146
						4 NC		ZQ 900-04	101184416
						1 NO / 1 NC		ZQ 900-11	101184327
						1 NO / 3 NC		ZQ 900-13	101184332
						2 NO / 2 NC		ZQ 900-22	101184329
						2 NC		ZQ 900-02N	101186147
						4 NC		ZQ 900-04N	101184477
						1 NO / 1 NC		ZQ 900-11N	101184474
						1 NO / 3 NC		ZQ 900-13N	101184476
						2 NO / 2 NC		ZQ 900-22N	101184475

*DuplineSafe

A variety of other types of pull-wire emergency stop switches can be found at products.schmersal.com.

7. PULL-WIRE EMERGENCY STOP SWITCHES ACCESSORIES



Eyebolt	Anchoring hook	Wire thimbles
 <ul style="list-style-type: none"> ■ BM 10 x 40 101084928 ■ BM 8 x 70 stainless steel 101192471 ■ Included in delivery: Eyebolt with nut 	 <ul style="list-style-type: none"> Galvanised steel ■ ACC-EBLT-M8 103031495 ■ ACC-RBLT-M10 103031498 Stainless steel ■ ACC-EBLT-M8-RVA 103031496 ■ ACC-EBLT-M10-RVA 103031499 <p>Included in delivery: anchoring hooks incl. 2 nuts and washers</p>	 <ul style="list-style-type: none"> ■ Wire thimble ■ 3 mm stainless steel 101203472 ■ 5 mm stainless steel 101203476
Wire clamp	Duplex wire clamp	Egg-shaped wire clamp
 <ul style="list-style-type: none"> ■ Wire clamp ■ 3 mm stainless steel 101203477 ■ 5 mm stainless steel 101203478 	 <ul style="list-style-type: none"> ■ Duplex wire clamp 3 mm (stainless steel) 	 <ul style="list-style-type: none"> ■ Egg-shaped wire clamp, size 3
Pulley	Pulley	Tensioning Jack
 <ul style="list-style-type: none"> Galvanised steel ■ Pulley 101192433 	 <ul style="list-style-type: none"> Stainless steel ■ ACC-PWR-PLY 103037516 	 <ul style="list-style-type: none"> Galvanised steel ■ Tensioner M6 101087930 ■ Setting range 145 ... 225 mm Stainless steel ■ ACC-TBLE-RVA 103031494 ■ Setting range 180 ... 250 mm

For detailed information on selection, visit products.schmersal.com.

7. PULL-WIRE EMERGENCY STOP SWITCHES ACCESSORIES



Tension spring	Wire rope	Wire unit complete
 <p>ZQ 700 <ul style="list-style-type: none"> ACC-700-RZ173I 103005863 ZQ 900 (with elongation limiter) <ul style="list-style-type: none"> ACC-RS900-TS 103033772 RS655 / RS656 (with elongation limiter) ACC-RS65X-TS 103032772 </p>	 <p> <ul style="list-style-type: none"> Wire rope With red PVC sheath Ø total 5 mm Ø of the steel core 3 mm </p> <p style="text-align: right;">on request</p>	 <p> <ul style="list-style-type: none"> Wire unit complete Ready-to-fit Included in delivery: 1 Wire rope; 2 Wire clamps; 1 Duplex wire clamp; 1 Wire thimble; 1 Eyebolt </p> <p style="text-align: right;">on request</p>
S 900 rope tensioner	Cable gland	Cable gland with pressure compensation element
 <p> <ul style="list-style-type: none"> S 900 rope tensioner Smooth and time-saving adjustment </p>	 <p> Plastic <ul style="list-style-type: none"> ACC-CGLD-M20-P 103006013 ACC-CGLD-M25 (2 pieces) 103032752 Nickel plated brass <ul style="list-style-type: none"> ACC-CGLD-M20-MS 103006011 ACC-CGLD-M25-MS 103006012 </p>	 <p> Plastic <ul style="list-style-type: none"> ACC-CGLD-P-M25 (2 pieces) 103031491 Nickel plated brass <ul style="list-style-type: none"> ACC-CGLD-P-M25-MS (2 pieces) 103031489 Stainless steel <ul style="list-style-type: none"> Cable gland M. Pressure compensation M20x1.5 103007570 </p>
Locking screws	Mounting plate set	ACC-PWR-ESLB 103032469
 <p> Plastic <ul style="list-style-type: none"> Locking screw M20x1.5 101141761 ACC-BPL-M25 (2 pieces) 103032753 Nickel plated brass <ul style="list-style-type: none"> ACC-BPL-M20-MS 103006009 ACC-BPL-M25-MS 103006010 </p>	 <p> <ul style="list-style-type: none"> ZQ 700 ZQ 900 </p> <p style="text-align: right;">103003510 101193805</p>	 <p> <ul style="list-style-type: none"> Emergency-stop release cord marking label 50 pieces, according to EN ISO 13850 </p>

For detailed information on selection, visit products.schmersal.com.

8. EMERGENCY STOP CONTROL DEVICES

DESCRIPTION

COMMAND AND SIGNALLING DEVICES

Command and signalling devices makes communication possible between human beings and machines. People expect high levels of reliability from them. Intuitive operation is desirable not just from an ergonomic point of view, but also with regards to safety at work.

The type of machine and the ambient conditions mean that the demands made of command and signalling devices are very different. Consequently, there is a wide range of different designs available. In addition to classic command devices and indicator lights for installation on operator panels, pull-wire switches, foot switches, cross-switches and buttons as well as two-hand controls and enabling devices, for example are in common use.





As an all-rounder in the field of HMI components and systems, the Schmersal Group offers a range of products for (virtually) all areas of application. These also include a series of command and signalling devices that have been developed for dedicated use in industrial applications (series A), hygiene-sensitive areas (series N) as well as for extremely harsh ambient conditions (series E and R).

All our series are distinguished by their very high levels of quality and their long service lives. They are of modular structure, which means you can adapt them in an optimum way to meet the exact requirements of your own individual application.

With contact systems too, users have different choices. Apart from this, assembly housings are available for all three series. If desired, command and signalling devices are supplied pre-assembled or ready-to-connect to operating systems with housings.

Information for the selection of suitable safety relay modules can be found in the chapter "Safety relay modules" (refer to page 220).

EMERGENCY STOP COMMAND DEVICE

"E" program	"N" program	"R" program	"A" program
Applications under difficult operating conditions	Food, hygiene and outdoor applications	Heavy-duty applications	Industrial applications
			

For a detailed description and technical data of all command and signalling devices order our special catalogue "Command and Signalling Devices". Precise product information can be found in our online catalogue at products.schmersal.com.



Overview "E" program

1	EMERGENCY STOP "E" program
2	EMERGENCY STOP with release by key
4	Mounting flange ELM
5	Contact element EF
6	Spring element EFR
7	Securing plate

Overview "N" program

3	EMERGENCY STOP "N" program
4	Mounting flange ELM
5	Contact element EF
6	Spring element EFR
7	Securing plate

Overview "R" program

8	EMERGENCY STOP "R" program	
9	Mounting flange	EFM
10	Contact elements RF...	

Overview "A" program

11	EMERGENCY STOP "A" program
12	Contact element AF...

Overview accessories

13	EMERGENCY STOP label
14	EMERGENCY STOP protective collar
15	EMERGENCY STOP protective collar bracket
16	EMERGENCY STOP enclosure for surface mounting
17	Stainless steel enclosure for surface mounting

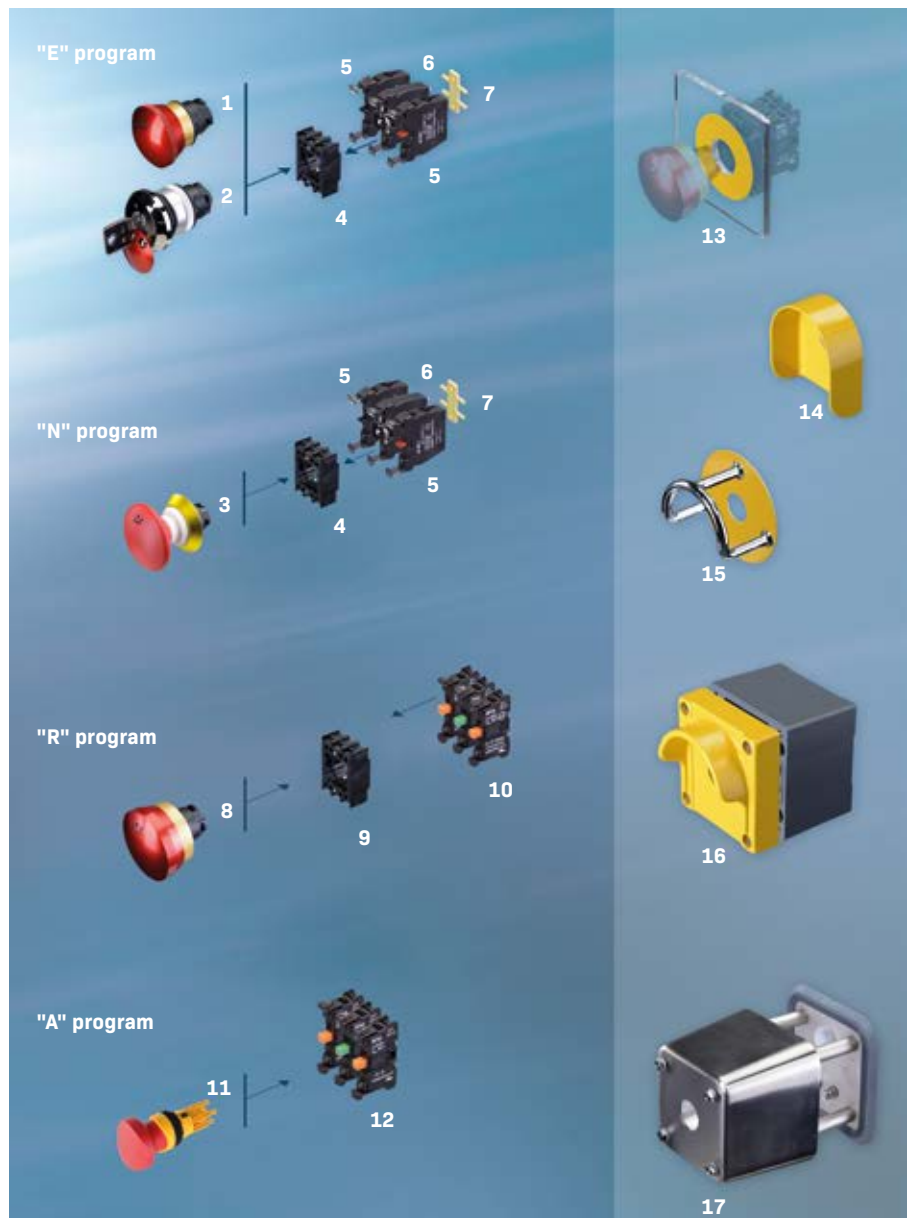

8. EMERGENCY STOP CONTROL DEVICES

"E" PROGRAM



■ EDRZ40RT



■ EDRR40RT



■ EDRRS40RT

Key Features

- | | | |
|---|---|--|
| <ul style="list-style-type: none"> ▪ EMERGENCY STOP command device to EN ISO 13850 ▪ Pull-to-unlatch mechanism ▪ Applications under difficult operating conditions ▪ Mounting-Ø 22.3 mm and 30.5 mm | <ul style="list-style-type: none"> ▪ EMERGENCY STOP command device to EN ISO 13850 ▪ Twist and pull-to-unlatch mechanism ▪ Applications under difficult operating conditions ▪ Mounting-Ø 22.3 mm and 30.5 mm | <ul style="list-style-type: none"> ▪ EMERGENCY STOP command device to EN ISO 13850 ▪ Key unlatching mechanism ▪ Applications under difficult operating conditions ▪ Mounting-Ø 22.3 mm and 30.5 mm |
|---|---|--|

Technical features

Mechanical data			
Housing material			
Material of operating element	Aluminium	Aluminium	Chrome-plated brass
Material front ring	Aluminium	Aluminium	Aluminium
Colour	■	■	■
Front panel thickness	1 ... 6 mm	1 ... 6 mm	1 ... 6 mm
Snap-action mechanism			
Integrated	■	-	-
Externally via additional module	-	■	■
Mounting			
Mounting flange included in delivery	■	■	■
Ambient conditions			
Ambient temperatures	-25 °C ... +75 °C	-25 °C ... +75 °C	-25 °C ... +75 °C
Degree of protection	IP65	IP65	IP65

Safety classification *

Standards	EN ISO 13849-1	EN ISO 13849-1	EN ISO 13849-1
B ₁₀₀ NC contact	100,000	100,000	100,000
Certificates *	cULus	cULus	cULus

* Note: In conjunction with the corresponding contact elements.



Detailed product information can be found in our online catalogue at products.schmersal.com.

8. EMERGENCY STOP CONTROL DEVICES "E" PROGRAM



Type	Unlocking	Snap-action mechanism	A	B	C	Type	Material number
Emergency stop command devices	Pull-to-unlatch mechanism	Integrated	29 mm	22.3 mm	38.5 mm	EDRZ40RT	101177107
				30.5 mm		EDRZ40VHRT	101182360
	Twist and pull-to-unlatch mechanism	External with spring element EFR *	29 mm	22.3 mm	38.5 mm	EDRR40RT	101021009
					49 mm	EDRR50RT	101021015
				30.5 mm	38.5 mm	EDRR40VHRT	101024290
					49 mm	EDRR50VHRT	101024299
	Release by key (cover red)	External with spring element EFR.EDRRS *	29 mm	22.3 mm	37.5 mm	EDRRS40RT	101025432
						30.5 mm	EDRRS40VHRT

* Spring element EFR or EFR.EDRRS must be ordered separately!

Key

- A Height Height of command device in front of the front panel
- B Mounting-Ø Installation diameter for the command device head
- C Key Ø Width of command device head

8. EMERGENCY STOP CONTROL DEVICES

"N" PROGRAM



■ NDRZ50RT











■ ND RR50RT

Key Features

- EMERGENCY STOP command device to EN ISO 13850
- Pull-to-unlatch mechanism
- Food, hygiene and outdoor applications
- Mounting-Ø 22.3 mm

- EMERGENCY STOP command device to EN ISO 13850
- Pull-to-unlatch mechanism
- Food, hygiene and outdoor applications
- Mounting-Ø 22.3 mm

Technical features

Mechanical data		
Housing material		
Material of operating element	ABS	ABS
Material front ring	ABS	ABS
Colour of the operating element		
Colour of sealing membranes		
Front panel thickness	1 ... 6 mm	1 ... 6 mm
Snap-action mechanism		
Integrated		-
Externally via additional module	-	
Mounting		
Mounting flange included in delivery		
Ambient conditions		
Ambient temperatures	-25 °C ... +80 °C	-25 °C ... +80 °C
Degree of protection	IP69K	IP69K

Safety classification *

Standards	EN ISO 13849-1	EN ISO 13849-1
B₁₀₀ NC contact	100,000	100,000
Certificates *	BG, cULus	BG, cULus

* Note: In conjunction with the corresponding contact elements.



Detailed product information can be found in our online catalogue at products.schmersal.com.

8. EMERGENCY STOP CONTROL DEVICES "N" PROGRAM



Type	Unlocking	Snap-action mechanism	Front ring	Bellows	A	B	C	Type	Material number
Emergency stop command devices	Pull-to-unlatch mechanism	Integrated	yellow	white	45 mm	22.3 mm	50 mm	NDRZ50RT-2905-1 ²⁾	103011890
				black				NDRZ50GR/RT-2905-1 ²⁾	103011811
				blue				NDRZ50BL/RT-2905-1 ²⁾	103011891
		External with spring element EFR ¹⁾	yellow	white				NDRR50RT-2905-1 ²⁾	103013775
				black				NDRR50GR/RT-2905-1 ²⁾	103013777
				blue				NDRR50BL/RT-2905-1 ²⁾	103013778

¹⁾ Spring element EFR must be ordered separately.

²⁾ Appendix 2905-1: Yellow front ring, which means that emergency stop sign can be dispensed with.

Key

A	Height	Height of command device in front of the front panel
B	Mounting-Ø	Installation diameter for the command device head
C	Key Ø	Width of command device head

8. EMERGENCY STOP CONTROL DEVICES

"R" PROGRAM



■ RDRZ45RT

Key Features

- EMERGENCY STOP command device to EN ISO 13850
- Pull-to-unlatch mechanism
- Heavy-duty applications
- Mounting-Ø 22.3 mm

Other versions are available

ATEX / IECEx



Technical features

Mechanical data

Housing material

Material of operating element

Aluminium

Material front ring

Aluminium

Colour of the operating element



Front panel thickness

1 ... 6 mm

Snap-action mechanism

Integrated



Externally via additional module

–

Mounting

Mounting flange included in delivery



Ambient conditions

Ambient temperatures

–25 °C ... +75 °C

Degree of protection

IP65

Safety classification *

Standards

EN ISO 13849-1

B_{1.00} NC contact

100,000

Certificates *

cULus

* Note: In conjunction with the corresponding contact elements.



Detailed product information can be found in our online catalogue at products.schmersal.com.

8. EMERGENCY STOP CONTROL DEVICES "R" PROGRAM



Type	Unlocking	Snap-action mechanism	A	B	C	Type	Material number
EMERGENCY STOP command device	Pull-to-unlatch mechanism	Integrated	27.5 mm	22.3 mm	45 mm	RDRZ45RT	101193576

Key

A	Height	Height of command device in front of the front panel
B	Mounting-Ø	Installation diameter for the command device head
C	Key Ø	Width of command device head

EMERGENCY STOP complete housing



8. EMERGENCY STOP CONTROL DEVICES – A PROGRAM

EMERGENCY STOP CONTROL DEVICES



■ ADRR40

Key Features

- EMERGENCY STOP command device to EN ISO 13850
- Pull-to-unlatch mechanism
- Industrial applications
- Mounting-Ø 22.3 mm

Other versions are available

Mounted in housing	MBKAC311YE-ADRR40RT-2NC
--------------------	-------------------------

Technical features

Mechanical data	
Housing material	
Material of operating element	Plastic
Material front ring	Plastic
Colour	
Design	round
Front panel thickness	1 ... 6 mm
Unlocking type	Pull-to-unlatch mechanism
Snap-action mechanism	
Integrated	■
Externally via additional module	-
Mounting	
Connection:	Knurled nut, central mounting
Mounting position	Arbitrarily
Ambient conditions	
Ambient temperatures	-25 °C ... +60 °C
IP Degree of protection	IP65

Safety classification

Standards	EN ISO 13849-1
B ₁₀₀ NC contact	100,000 operations
Certificates	cULus
Notice	cULus in conjunction with the corresponding contact elements only

8. EMERGENCY STOP CONTROL DEVICES – A PROGRAM

EMERGENCY STOP CONTROL DEVICES



Type	Unlocking	Snap-action mechanism	A	B	C	Type	Material number
EMERGENCY STOP command devices	Pull-to-unlatch mechanism	Integrated	38 mm	22.3 mm	40 mm	ADRR40RT	101030271
EMERGENCY STOP complete housing	Pull-to-unlatch mechanism	Integrated	93 mm	-	40 mm	MBKAC311YE-ADRR-40RT-2NC	103009572
EMERGENCY STOP complete housing	Pull-to-unlatch mechanism	Integrated	93 mm	-	40 mm	MBKAC311YE-ADRR-40RT-2NC-1NO	103011887

All dimensions in mm.

Key

A	Height	Height of command device in front of the front panel
B	Mounting-Ø	Installation diameter for the command device head
C	Key Ø	Width of command device head

EMERGENCY STOP complete housing



8. EMERGENCY STOP CONTROL DEVICES CONTACT ELEMENTS



■ EF



■ RF



■ AF

Key Features

▪ Contact elements for "E" and "N" program

▪ Contact elements for "R" program

▪ Contact elements for "A" program

Other versions

ATEX / IECEx

–

■

–

Technical features

Electrical characteristics

Max. switching capacity U/I

250 VAC / 8 A;
24 VDC / 5 A

250 VAC / 6 A;
24 VDC / 3 A

250 VAC / 6 A;
24 VDC / 3 A

Switching of low voltages

> 5 VDC / 3.2 mA

>5VDC / 1 mA

–

Switching frequency¹⁾

1,200/h

1,200/h

1,200/h

Mechanical data

Material

Material of the housings

Plastic,
glass-fibre-reinforced,
self-extinguishing

Plastic,
glass-fibre-reinforced,
self-extinguishing

Plastic,
self-extinguishing

Material of the contacts

Fine-silver,
phosphor bronze
or brass carrier

Fine-silver,
phosphor bronze
or brass carrier

Fine-silver,
phosphor bronze
or brass carrier

Termination

Screw connection

■

■

■

Flat plug-in connector

■

–

–

Cable section

Solid wire

2 x (0.5 ... 2.5 mm²)

2 x (0.5 ... 2.5 mm²)

2 x 1.5 mm²

stranded wire

2 x (0.5 ... 1.5 mm²)

2 x (0.5 ... 1.5 mm²)

2 x 1.5 mm²

Ambient conditions

Ambient temperature

–25 °C ... +80 °C

–25 °C ... +75 °C

–25 °C ... +60 °C

Resistance to shock

110 g / 4 ms ... 30 g /
18 ms
no bouncing

110 g / 4 ms ... 30 g /
18 ms
no bouncing

30 g / 18 ms

Resistant to vibration

> 20 g / 10 ... 200 Hz

> 20 g / 10 ... 200 Hz

20 g / 10 ... 150 Hz

Degree of protection²⁾

IP20

IP20

IP20

Safety classification

Standards

EN ISO 13849-1

EN ISO 13849-1

EN ISO 13849-1

B₁₀₀ NC contact

100,000

100,000

100,000

Certificates

cULus, CCC, EAC

cULus, EAC

cULus

¹⁾ The switching frequency of emergency stop command devices is only 600/h.

²⁾ With plug-in connectors, depends on the connector plug used.

8. EMERGENCY STOP CONTROL DEVICES

CONTACT ELEMENTS



Type EF	Function	Switch travel diagram	Position	Wiring configuration according to DIN 50005	Screw connection
Contact element	2 NC		1	11-12/21-22	EF220.1
			2	31-32/41-42	EF220.2
	1 NC / 1 NO		1	11-12/23-24	EF303.1
			2	31-32/43-44	EF303.2

Type EF	Function	Position	Description
Spring element	Snap-action mechanism with latching	3	EFR or EFR.EDRRS

Design

A command or signalling device consists of an actuator, a mounting flange and a contact or light element of type EF or EL/ELDE (in the case of EMERGENCY STOP devices, plus a spring element (if applicable).

Assembly example

This example shows an EMERGENCY STOP push button with ELM mounting flange, an EFR spring element and 2 EF... contact elements.

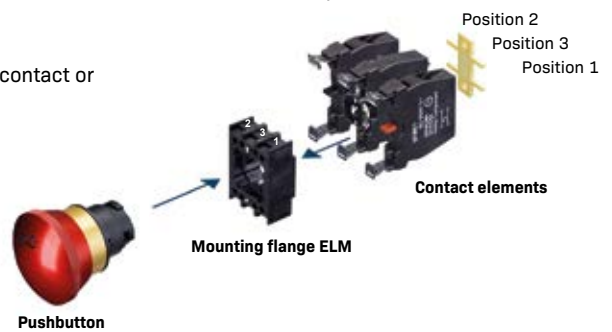

Type RF	Function	Switch travel diagram	Position	Connector	Plunger colour	Contact labelling	Type designation
Contact element	1 NC		1, 2 and 3	Screw connection	red	1, 2	RF10
	1 NO		1, 2 and 3	Screw connection	green	3, 4	RF03

Design

A command or signalling device consists of an actuator, a mounting flange and a contact or light element of type RF or RL/RLDE.

Assembly example

This example shows an EMERGENCY STOP push button with EFM mounting flange and 3 RF... contact elements.

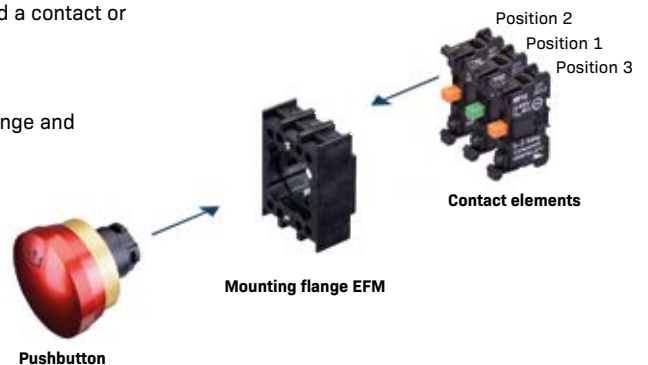



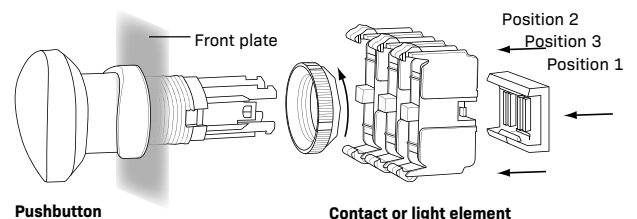

Typ AF	Function	Switch travel diagram	Position	Connector	Plunger colour	Contact labelling	Type designation
Contact element	1 NC		1, 2 and 3	Screw connection	red	1, 2	AF10
	1 NO		1, 2 and 3	Screw connection	green	3, 4	AF02



8. EMERGENCY STOP CONTROL DEVICES ASSEMBLY HOUSING

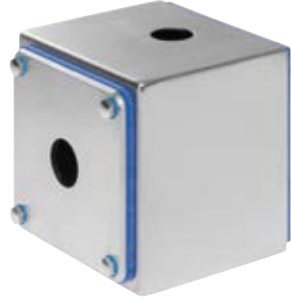

MBK	NBG	MBGAC
 <ul style="list-style-type: none"> ■ Housing material, plastic ■ For EMERGENCY STOP without protective collar 	 <ul style="list-style-type: none"> ■ Enclosure material, stainless steel 	 <ul style="list-style-type: none"> ■ Enclosure material, alloy ■ For EMERGENCY STOP without protective collar <p style="text-align: right;">MBGAC MBGHAC</p>
MBKAC	MBGAC	NBGLC11
 <ul style="list-style-type: none"> ■ EMERGENCY STOP complete housing ■ Housing material, plastic ■ With EMERGENCY STOP without protective collar 	 <ul style="list-style-type: none"> ■ EMERGENCY STOP complete housing ■ Enclosure material, alloy ■ With EMERGENCY STOP both with and without protective collar 	 <ul style="list-style-type: none"> ■ Enclosure material, stainless steel ■ For EMERGENCY STOP with and without protective collar

Type	Housing	Housing material	Number of drilled holes	Dimensions (W x H x D)	Mounting hole for cable entry	Type designation	Recommended for product portfolio			
							E	N	R	A
MBK	Empty enclosure / Complete housing	Plastic	1	85 x 84 x 85 mm	M20	MBK311GB	■		■	■
NBG		Stainless steel	1	110 x 88 x 110 mm	M20	NBG311		■		
NBGLC		Stainless steel	1	100 x 95 x 100 mm	M20	NBGLC11		■		
MBKAC		Plastic	1	80 x 55 x 80 mm	M20	MBKAC311YE				■
MBGAC		Alloy	1	100 x 80 x 100 mm	M20	MBGAC311YE	■		■	■
		Alloy	1	100 x 80 x 100 mm	M20	MBGHAC311YE	■		■	

Detailed product information can be found in our online catalogue at products.schmersal.com.

8. EMERGENCY STOP CONTROL DEVICES ACCESSORIES



Emergency stop label	Emergency stop protective collar	Emergency stop protective collar
 <ul style="list-style-type: none"> ■ NDP-70 ■ Material V4A ■ Yellow powder-coated 	 <ul style="list-style-type: none"> ■ EDRR-1 SET ■ Aluminium die-cast ■ Yellow powder-coated 	 <ul style="list-style-type: none"> ■ NSK/V4A/GB ■ Bracket material 1.4550 plate V4A powder-coated
Mounting flange	Position switch	
 <ul style="list-style-type: none"> ■ EFMH ■ Mounting flange for E and N product portfolio position switches PS116 ■ Depending on the version, with position switch included in delivery too 	 <ul style="list-style-type: none"> ■ PS116-...-S200 ■ Thermoplastic enclosure ■ Symmetrical casing ■ Degree of protection IP66, IP67 ■ Connector plug M12 or cable 	

Type	Description	Type designation	Recommended for product portfolio			
			E	N	R	A
Emergency stop label	Installation Ø for 22.3 mm, 53 mm external Ø	MDP-8	■		■	■
	Installation Ø for 22.3 mm, 100 mm external Ø	MDP-6	■		■	■
	Installation Ø for 30.5 mm, 53 mm external Ø	DPF-9	■		■	
	Installation Ø for 30.5 mm, 100 mm external Ø	DPF-7	■		■	
	Mounting-Ø for 22.3 mm, external Ø 70 mm, V4A version, colour yellow, self-adhesive, no labelling	NDP-70	■	■	■	■
	Mounting-Ø for 22.3 mm, external Ø 65 mm, plastic – as adhesive foil	NDP-65	■	■	■	■
Protective collar	EMERGENCY STOP protective collar, mounting-Ø for 22.3 mm operating element Ø 38.5 mm	EDRR-1 SET	■			
	EMERGENCY STOP protective collar, mounting-Ø for 22.3 mm operating element Ø 49 mm	EDRR-2 SET	■		■	
	EMERGENCY STOP protective collar, mounting-Ø for 30.5 mm operating element Ø 38.5 mm	EDRR-1.1 SET	■			
	EMERGENCY STOP protective collar, mounting-Ø for 30.5 mm operating element Ø 49 mm	EDRR-2.1 SET	■		■	
	EMERGENCY STOP protective collar, material 1.4550, incl. fastening screws	NSK/V4A/GB		■		
Mounting flange	Mounting flange for position switch PS116	EFMH	■	■		
Position switch	Position switch PS116 for "E" and "N" program	PS116-...-S200	■	■		

9. CONTROL PANELS DESCRIPTION

AREA OF APPLICATION

Ergonomic operation of the main machine functions at the human-machine interface is a key factor in safety. The control units should be mounted as close as possible to the safety doors so that operators have an overview of the process.

BDF Series control units meet this requirement. This series has been designed for mounting onto the commercially available aluminium profile systems of machine enclosures and you can quickly attach them and integrate them in the ambient structure.

DESIGN AND WAY OF FUNCTIONING

The range is based on a high-quality design with slim-line housing (only 40 mm) made from impact-resistant plastic. Two designs are available to accommodate one or four command devices or indicator lights.

Users can choose from a large product portfolio of illuminated control push buttons, selector switches and selector buttons, LED illuminated indicators, key-operated switches and standards-compliant EMERGENCY STOP command devices. Positioning of the pushbuttons on the control panel is also freely selectable. Labelling fields allow you to label the functions individually.

This makes it possible for machine builders to use the BDF range to represent the most common operator functions like EMERGENCY STOP, ON / OFF, Forwards / Backwards, Operating Mode Selection, display of operating status conditions or error messages, etc. All the command devices and indicator lights have been developed for industrial applications and have been tried and tested in other series of the command device product portfolio.

Information for the selection of suitable safety relay modules can be found in the chapter "Safety relay modules" (refer to page 220).

The system also includes a mounting plate to combine the control panel with a solenoid interlock and an ergonomic door handle.

In addition to the standard version for parallel wiring, versions with different communications interfaces are also available such as the AS-Interface Safety at Work (AS-i SaW), the serial diagnostic interface (SD) and for use on the secure field box SFB.

An overview of the combination options for the command and signalling devices as well as the preferred types of the AS-i, SD and FB versions can be found on page 166.

Further information on the version with the integrated AS interface can be found in the chapter on AS interface Safety at Work starting on page 258.

The version with integrated SD interface has been designed for use in the serial diagnostic interface. The serial diagnostic interface is outlined in the chapter on the SD interface starting on page 270.

Version BDF 200-FB is available for connection of the control panel to the secure field box SFB. The secure field box SFB is outlined in the chapter on secure field boxes start on page 276.



SAMPLE APPLICATION



The photo shows a combination with the BDF200 and an AZM201 solenoid interlock, including a B30 door-handle actuator with the mounting plate as an elegant safety door solution. This positive connection between the BDF200 control panel and the AZM201 solenoid interlock offers machine operators a whole new level of convenience.

9. CONTROL PANELS

OVERVIEW OF THE SERIES



■ BDF100...-NH



■ BDF100...

Key Features

- Control panel with EMERGENCY STOP
- EMERGENCY STOP function with and without protective collar
- Slim, shock-resistant thermoplastic enclosure
- For mounting on commercially available aluminium profile systems

- Control panel with one control element
- Slim, shock-resistant thermoplastic enclosure
- For mounting on commercially available aluminium profile systems
- Large product portfolio of operating and lighting elements

Other versions

AS-i SaW (see page 258)	–	–
SD interface (see page 270)	–	–

Technical features

Electrical characteristics		
Max. switching capacity U/I	24 VAC / 2 A; 24 VDC / 1 A	24 VAC / 2 A; 24 VDC / 1 A
Switching of low voltages	5 V / 1 mA	5 V / 1 mA
Circuit versions		
EMERGENCY STOP	2 NC/1 NO	–
Command devices	–	1 NO / 1 NC; 2 NO
EMERGENCY STOP with indicator lamp	2 NC/1 NO	–
Command devices with indicator lamp	–	1 NO / 1 NC; 2 NO
Mechanical data		
Housing material	Glass-fibre reinforced thermoplastic, self-extinguishing	Glass-fibre reinforced thermoplastic, self-extinguishing
Dimensions (W x H x D)		
With protective collar	40 x 99 x 69 mm	–
Without protective collar	40 x 99 x 49 mm	40 x 99 x 49 mm
Termination	Connector plug M12, 8-pole	Connector plug M12, 8-pole
Ambient conditions		
Ambient temperature	–25 °C ... +65 °C	–25 °C ... +65 °C
Degree of protection	IP65	IP65

Safety classification

Standards	EN ISO 13849-1	EN ISO 13849-1
B _{10D} NC contact	100,000	100,000
Certificates	cULus*, EAC	cULus*, EAC



To get detailed information about the products and certificates, visit products.schmersal.com.



■ BDF200-NH-...



■ BDF200...



■ BDF200-NH-...-2920



■ BDF200-...-2920

- Control panel with EMERGENCY STOP and 3 control elements
- EMERGENCY STOP function with and without protective collar
- Slim, shock-resistant thermoplastic enclosure
- For mounting on commercially available aluminium profile systems
- Large product portfolio of operating and lighting elements

- Control panel with 4 control elements
- Slim, shock-resistant thermoplastic enclosure
- For mounting on commercially available aluminium profile systems
- Large product portfolio of operating and lighting elements

- Connector plug M12, 12-pole
- Control panel with emergency stop and 3 control elements
- EMERGENCY STOP function with and without protective collar
- Slim, shock-resistant thermoplastic enclosure
- For mounting on commercially available aluminium profile systems
- Large product portfolio of operating and lighting elements

- Connector plug M12, 12-pole
- Control panel with 4 control elements
- Slim, shock-resistant thermoplastic enclosure
- For mounting on commercially available aluminium profile systems
- Large product portfolio of operating and lighting elements

■	-	-	-
■	-	-	-

24 VAC / 2 A; 24 VDC / 1 A	24 VAC / 2 A; 24 VDC / 1 A	24 VAC / 1.5 A; 24 VDC / 1 A	24 VAC / 1.5 A; 24 VDC / 1 A
5 V / 1 mA	5 V / 1 mA	5 V / 1 mA	5 V / 1 mA
2 NC/1 NO	-	2 NC	-
1 NC /1 NO; 2 NO	1 NC /1 NO; 2 NO	1 NC/1 NO	1 NC/1 NO
2 NC	-	-	-
1 NO	1 NO	-	-
Glass-fibre reinforced thermoplastic, self-extinguishing	Glass-fibre reinforced thermoplastic, self-extinguishing	Glass-fibre reinforced thermoplastic, self-extinguishing	Glass-fibre reinforced thermoplastic, self-extinguishing
40 x 220 x 69 mm	-	40 x 220 x 69 mm	-
40 x 220 x 49 mm	40 x 220 x 49 mm	40 x 220 x 49 mm	40 x 220 x 49 mm
M20 cable gland with plug-in terminals	M20 cable gland with plug-in terminals	Connector plug M12, 12-pole	Connector plug M12, 12-pole
-25 °C ... +65 °C	-25 °C ... +65 °C	-25 °C ... +65 °C	-25 °C ... +65 °C
IP65	IP65	IP65	IP65











EN ISO 13849-1	EN ISO 13849-1	EN ISO 13849-1	EN ISO 13849-1
100,000	100,000	100,000	100,000
cULus*, EAC	cULus*, EAC	cULus*, EAC	cULus*, EAC

* Approval under preparation.

9. CONTROL PANELS

CONTROL ELEMENTS



Emergency stop pushbutton NH	Emergency stop pushbutton NHK	Pushbutton DT..				
 <ul style="list-style-type: none"> ■ Mushroom-shaped plastic button, Ø 30 mm ■ Without protective collar: ordering suffix NH ■ Pull to reset ■ 1 NO contact / 2 NC contacts 	 <ul style="list-style-type: none"> ■ Mushroom-shaped plastic button, Ø 30 mm ■ With protective collar: ordering suffix NHK ■ Pull to reset ■ 1 NO contact / 2 NC contacts 	 <ul style="list-style-type: none"> ■ With concave button, button surface 19 x 19 mm ■ 2 NO contacts or 1 NO contact / 1 NC contact ■ Printing is possible on request ■ Refer to the table below for the ordering suffix 				
Indicator lights LM..	Mushroom push button PT..	Illuminated pushbutton LT..				
 <ul style="list-style-type: none"> ■ Illuminated surface 19 x 19 mm ■ Lamp replacement at the front ■ Printing is possible on request ■ Refer to the table below for the ordering suffix 	 <ul style="list-style-type: none"> ■ Button surface 25 x 25 with rounded edges ■ Without latching ■ 2 NO contacts or 1 NO contact / 1 NC contact ■ Printing is possible on request ■ Refer to the table below for the ordering suffix 	 <ul style="list-style-type: none"> ■ With concave button, button surface 19 x 19 mm ■ 2 NO contacts or 1 NO contact / 1 NC contact ■ Lamp replacement at the front ■ Printing is possible on request ■ Refer to the table below for the ordering suffix 				
Ordering suffix	yellow	red	green	blue	black	white
 Mushroom push button PT..	PTYE	PTRD	PTGN	PTBU	PTBK	PTWH
 Pushbutton DT..	DTYE	DTRD	DTGN	DTBU	DTBK	DTWH
 Illuminated pushbutton LT..	LTYE	LTRD	LTGN	LTBU	/	LTWH
 Indicator lights LM..	LMYE	LMRD	LMGN	LMBU		LMWH







For detailed information on selection, visit products.schmersal.com.

9. CONTROL PANELS

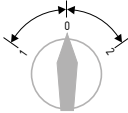
CONTROL ELEMENTS

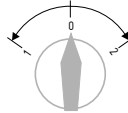
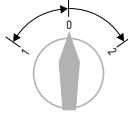

Maintained selector switches / spring-return selector switches	Maintained selector switches / spring-return selector switches	Key-operated selector switches/buttons
 <ul style="list-style-type: none"> Version with standard toggle, anthracite Refer to the table below for the ordering suffix 	 <ul style="list-style-type: none"> Version with long toggle, anthracite Refer to the table below for the ordering suffix 	 <ul style="list-style-type: none"> Version with high-quality cylinder lock; therefore, IP65 in this case too Key can be removed in all positions Refer to the table below for the ordering suffix

Ordering suffix	Selector switch	Selector switch	Selector switch	Selector switch	Selector switches
					
	1 latched position	2 latched positions to the left/right of the zero position	1 momentary position and automatic return to the zero position	2 touch positions to the left/right of the zero position and automatic return to the zero position	1 momentary position on the right and automatic return to the zero position and 1 maintained position to the left of the zero position
	2 NO or 1 NO / 1 NC	1 NO per position or 1 NC (position 1) / 1 NO (position 2)	2 NO or 1 NO / 1 NC	1 NO per position or 1 NC (position 1) / 1 NO (position 2)	1 NO per position or 1 NC (position 1) / 1 NO (position 2)
 Standard toggle	WS20	WS30*	WT20	WT30*	WTS30*
 Long toggle	WS21	WS31*	WT21	WT31*	WTS31*
 Key-operated switch	SWS20		SWT20		







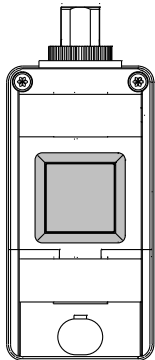

* Not for -2920 version.

For detailed information on selection, visit products.schmersal.com.

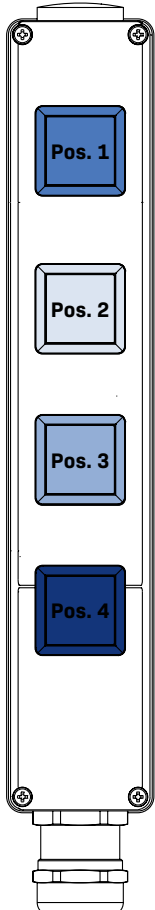
9. CONTROL PANELS

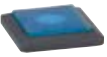
COMBINATION OPTIONS





Control elements		BDF100 with	BDF200				Control panels
			At pos. 1	At pos. 2	At pos. 3	At pos. 4	
	NH	•	•				BDF100 
	NHK	•	•				
	PT..		•	•	•	•	BDF200 
	DT..	•	•	•	•	•	
	LT..	•	•	•	•	•	
	LM..		•	•	•	•	
	SW.20	•		•	•		
	W..0	•		•	•		
	W..1	•		•	•		

9. CONTROL PANELS

PREFERRED TYPES AND ACCESSORIES



Series	Fitting Pos. 1	Pos. 2	Pos. 3	Pos. 4	Indicator lamp	Type designation	Material number
BDF100 	NH	---	---	---	red	BDF100-NH-G-ST	101215862
	NHK	---	---	---		BDF100-NHK-G-ST	101211974
	LTBU	---	---	---	---	BDF100-11-LTBU-ST	101216402
	LTGN	---	---	---		BDF100-11-LTGN-ST	101216247
	SWS20	---	---	---		BDF100-11-SWS20-ST	101217193
	WS20	---	---	---	green	BDF100-11-WS20-G/GN-ST	103001068
	LTBU	---	---	---	---	BDF100-20-LTBU-ST	101217770
	LTGN	---	---	---		BDF100-20-LTGN-ST	101217217
BDF200 	NH	LT	LT	LT	red	BDF200-NH-10-LT-LT-LT-G24-2875 ¹⁾	103007781
		LT	LT	LT	---	BDF200-NH-11-LT-LT-LT-2875 ¹⁾	103007782
		LT	LT	LT		BDF200-NH-11-LT-LT-LT-2875/2920 ¹⁾²⁾	103015461
		LT	LT	LT		BDF200-NH-20-LT-LT-LT-2875 ¹⁾	103007783
		SWS20	LT	LT		BDF200-NH-11-SWS20-LT-LT-2875 ¹⁾	103007789
		SWS20	LT	LT		BDF200-NH-20-SWS20-LT-LT-2875 ¹⁾	103007790
	NHK	LT	LT	LT		red	BDF200-NHK-10-LT-LT-LT-G24-2875 ¹⁾
		LT	LT	LT	---	BDF200-NHK-11-LT-LT-LT-2875 ¹⁾	103007785
		LT	LT	LT		BDF200-NHK-11-LT-LT-LT-2875/2920 ¹⁾²⁾	103026143
		LT	LT	LT		BDF200-NHK-20-LT-LT-LT-2875 ¹⁾	103007786
		SWS20	LT	LT		BDF200-NHK-11-SWS20-LT-LT-2875 ¹⁾	103007791
		SWS20	LT	LT		BDF200-NHK-20-SWS20-LT-LT-2875 ¹⁾	103007792
	LT	LT	LT	LT		---	BDF200-LT-11-LT-LT-LT-2875 ¹⁾
		LT	LT	LT	BDF200-LT-11-LT-LT-LT-2875/2977 ¹⁾²⁾		103025115
		LT	LT	LT	BDF200-LT-20-LT-LT-LT-2875 ¹⁾		103007788

¹⁾ Type designation -2875: the coloured button caps are included in the scope of delivery as an accessory pack for customers to mount themselves.

²⁾ With connector plug M12, 12 pole.







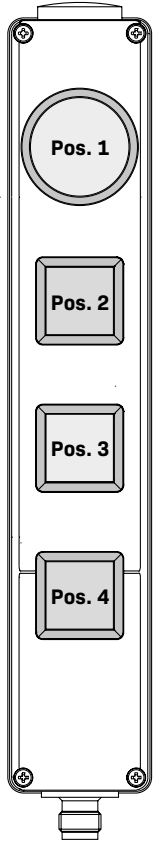

AZM201	MP BDF 200	101214126	SRB-E-402ST
 <ul style="list-style-type: none"> Can be combined with the AZM201 solenoid interlock For more information, visit products.schmersal.com 	 <ul style="list-style-type: none"> Mounting plate for combination of AZM201 solenoid interlock with -B30 actuator and BDF200 control panel 	 <ul style="list-style-type: none"> 2x function STOP 0 2x 1- or 2-channel control 2x start button / autostart 2 safety contacts 2 safety outputs For more information, visit products.schmersal.com 	

To see a wide range of other types, visit products.schmersal.com.

9. CONTROL PANELS

COMBINATION OPTIONS AS-I, SD, FB



Control elements	BDF200-AS / SD / FB				Control panels
	At pos. 1	At pos. 2	At pos. 3	At pos. 4	
 NH	•				
 NHH	•				
 PT..		•	•	•	
 DT..		•	•	•	
 LT..		•	•	•	
 LM..		•	•	•	
 SW.20		•	•		
 W..0		•	•		
 W..1		•	•		

9. CONTROL PANELS

PREFERRED TYPES AS-I, SD, FB



Series	Fitting At pos. 1	Pos. 2	Pos. 3	Pos. 4	Indicator lamp	Type designation	Material number
Variant: AS-Interface							
NH	LT	LT	LT		red/green	BDF200-ST1-AS-NH-LT-LT-LT-G24-2875 ¹⁾	103012552
	LMRD	LTWH	LTBU		---	BDF200-ST1-AS-NH-LMRD-LTWH-LTBU	101214617
	LTRD	LTGN	LTBU		---	BDF200-ST1-AS-NH-LTRD-LTGN-LTBU	103003704
	WS20	LTWH	LTGN		---	BDF200-ST1-AS-NH-WS20-LTWH-LTGN	103013250
	LTGN	LYE	LTWH		red/green	BDF200-ST1-AS-NH-LTGN-LTYE-LTWH-G24	103005880
NHK	LMRD	LTWH	LTBU		---	BDF200-ST1-AS-NHK-LMRD-LTWH-LTBU	101215387
	LTRD	LTWH	LTBU		---	BDF200-ST1-AS-NHK-LTRD-LTWH-LTBU	103000961
	LTBU	LYE	LTGN		red/green	BDF200-ST1-AS-NHK-LTBU-LTYE-LTGN-G24	103013865
	WS20	LTWH	LTGN		---	BDF200-ST1-AS-NHK-WS20-LTWH-LTGN	103013250
	SWS20	LTWH	LTBU		red/green	BDF200-ST1-AS-NHK-SWS20-LTWH-LT-BU-G24	101214618
Variant: SD interface							
NH	LT	LT	LT		---	BDF200-SD-NH-LT-LT-LT-2875 ¹⁾	103015446
NHK	LT	LT	LT		---	BDF200-SD-NHK-LT-LT-LT-2875 ¹⁾	103025848
	SWS20	WS30	LTWH		red/green	BDF200-SD-NHK-SWS20-WS30-LTWH-G24	103015448
Variant: FB interface							
NH	LT	LT	LT		---	BDF200-FB-NH-LT-LT-LT-2875 ¹⁾	103015447
NHK	WS20	LTBU	LTBU		red/green	BDF200-FB-NHK-WS20-LTBU-LTBU-G24	103025654
	SWS20	WS30	LTBU		red/green	BDF200-FB-NHK-SWS20-WS30-LTBU-G24	103015449

¹⁾ Type designation -2875: the coloured button caps are included in the scope of delivery as an accessory pack for customers to mount themselves.

10. ENABLING SWITCHES

DESCRIPTION

AREA OF APPLICATION

When carrying out set-up, refitting or service work on plant or machinery, it can be beneficial to partially or completely deactivate guard systems. Typically, this includes setting up a machine (set-up mode) and monitoring machining procedures (process monitoring).

One example: The operator of a machine tool is able to check format settings better and program movements more exactly if the safety door is open. The better view of the process makes operation more convenient and reduces set-up and refitting times.

Special safety measures are needed for this case and similar ones; these measures are referred to as special operating modes and are specified in the machine directive and in some type C standards.

The measures that are required in this case include enabling devices that operators must actuate to start up the respective machine functions. In many cases, this is a slowed-down machine movement. The effect of the guard system is only partially or entirely suspended for the time in which the operator presses the enabling device.

DESIGN AND WAY OF FUNCTIONING

Operators must put the enabling switch into the centre position and hold it in this position. As soon as they release the button or press it all the way down, the system interrupts the control command on a safety-related basis.

Series ZSD5 and ZSD6 enabling devices are of ergonomic design; with series ZSD6, an additional pushbutton is integrated in the device head. Operators can select the optimum position to the machine or the process; the connection to the machine controller is guaranteed by a signal line.

Both series are suitable for robot applications in accordance with ANSI standards. There are of course suitable safety relay modules available for signal evaluation.



PERMISSIBLE SPEEDS IN ENABLING MODE

It is controversial and standards deal differently with the question of what "reduced" speeds are justifiable in enabling mode to comply with the further condition of the machine directive (see Machine Directive Appendix I, Clause 1.2.5) that the operation of dangerous functions is only possible under minor risk conditions (= reduced speed, reduced power, step mode, etc.)

A man who has a C standard that offers concrete information that can be used for his individual application is a happy man.

Otherwise, it is advisable to differentiate between crushing and shearing hazards on the one hand and "just" collision hazards on the other. In this connection, people frequently quote values of 33 mm/sec. (2 m/min.) max. in the case of crushing and shearing hazards and 250 mm/sec. (15 m/min.) max. in the case of collision hazards ^A. MRL 2006/42/EG, however, "permits" higher values if absolutely technically necessary and execution is integrated into a considered and coherent safety concept ^{B/C}.

On the question as to whether the reduced speed (power, movement etc.) can be controlled via the operational controller or whether a safety-related controller or monitoring system is required – e.g. S(afety)L(imited)S(peed) and the like as per EN/IEC 61800-5-2 – refer first to the applicable standards (in some cases enabling devices are sufficient for low risks and a safe controller or monitoring system is only required in addition for greater risks, in some case there is also the general requirement "enabling device + e.g. SLS").

You must equally consider that the state of the art is tending towards "SLS for example" (i.e. "safe controllers or monitoring systems"), since more and more drives and drive controllers with integrated safety functions are on the market. However, it is not possible to use these new options in every situation whether due to compelling technical reasons and/or for reasons of cost.

It can help to consider whether pressing the enabling device through from stage 2 to stage 3, taking into account the machine's reaction time (delay time after signalling to standstill or non-critical speed) PLUS an additional human response time of 1 second, for example, results in an operating status that is acceptable to the machine operator from a safety point of view or not.

^A You can find an overview of the maximum speeds that there are for manual intervention on running machines in the IFA Manual (loose leaf collection – Lfg. 2/11 – XII/2011 – Clause 330 216).

^B See Machine Directive Appendix I, Clause 1.2.5: If it is not possible to comply with these requirements at the same time, the (mode selector switch) must trigger other protective measures ..., such that a safe working area is guaranteed.

^C See also specialist committee information sheet 002 of specialist committee MFS of DGUV Wood and Metal Professional Association, Mainz, Process Monitoring on the Shopfloor.

10. ENABLING SWITCHES

OVERVIEW OF THE SERIES



■ ZSD5



■ ZSD6

Key Features

- | | |
|---|---|
| <ul style="list-style-type: none"> ▪ 3-stage grip switch OFF-ON-OFF ▪ Contacts do not close on resetting from stage 3 → stage 1 | <ul style="list-style-type: none"> ▪ 3-stage grip switch OFF-ON-OFF ▪ Contacts do not close on resetting from stage 3 → stage 1 ▪ With additional pushbutton |
|---|---|

Technical features

Electrical characteristics		
Max. switching capacity U/I NO contacts	125 VAC / 1.5 A, 250 VAC / 0.75 A; 30 VDC / 1.0 A, 125 VDC / 0.22 A, 250 VDC / 0.1 A	125 VAC / 1.5 A, 250 VAC / 0.75 A; 30 VDC / 1.0 A, 125 VDC / 0.22 A, 250 VDC / 0.1 A
Auxiliary contacts	125 VAC / 1.5 A; 250 VAC / 0.75 A; 30 VDC / 2.3 A; 125 VDC / 0.22 A; 250 VDC / 0.1 A	125 VAC / 1.5 A; 250 VAC / 0.75 A; 30 VDC / 2.3 A; 125 VDC / 0.22 A; 250 VDC / 0.1 A
Additional push-button	-	125 VAC / 0.3 A; 30 VDC / 0.7 A; 125 VDC / 0.1 A
Mechanical data		
Housing material	Plastic	Plastic
Contacts	3	4
Switching frequency	max. 1200/h	max. 1200/h
Termination	Screw connection (under preparation: WAGO terminals)	Screw connection (under preparation: WAGO terminals)
Cable section	0.14 ... 1.5 mm ²	0.14 ... 1.5 mm ²
Ambient conditions		
Ambient temperature	-10 °C ... +60 °C	-10 °C ... +60 °C
Degree of protection	IP65	IP65

Safety classification

Standards	EN ISO 13849-1	EN ISO 13849-1
B₁₀₀ NC contact	100,000	100,000
Certificates	TÜV, cULus	TÜV, cULus



To get detailed information about the products and certificates, visit products.schmersal.com.

10. ENABLING SWITCHES

ORDERING DETAILS AND RECOMMENDED EVALUATIONS



Type	Description	Pre-wired Cable	Type	Material number
Enabling switch	3-stage grip switch	Without	ZSD5/0.LTG	101199467
		5 m	ZSD5/5M	101199469
	3-stage grip switch with additional pushbutton	Without	ZSD6/0.LTG	101199480
		5 m	ZSD6/5M	101210087
Accessories	Mounting angle made of metal		ZSD-H	101163725

RECOMMENDED EVALUATIONS

PROTECT SELECT	SRB-E-301ST	SRB-E-201LC
 <ul style="list-style-type: none"> ■ Evaluation of enabling devices ■ STOP 0 or STOP 1, depending on the setting values in the application program ■ For more information, visit products.schmersal.com 	 <ul style="list-style-type: none"> ■ Function STOP 0 ■ 1- or 2-channel control ■ Start button / autostart ■ 3 safe relay outputs 6 A ■ 1 signalling output ■ For more information, visit products.schmersal.com 	 <ul style="list-style-type: none"> ■ Function STOP 0 ■ 1- or 2-channel control ■ Start button / autostart ■ 2 safety outputs 2 A ■ 1 signalling output ■ For more information, visit products.schmersal.com

11. SAFETY FOOT SWITCHES

DESCRIPTION

AREA OF APPLICATION

Safety foot switches are used as enabling devices for machines and systems where, for example, a manual enabling operation is not possible.

Typical applications include metal forming machinery, woodworking machinery and equipment and machinery for the packaging technology industry.

DESIGN AND WAY OF FUNCTIONING

When the foot pedal is actuated as far as the pressure point, the NO contact is closed and the machine function is started. If the machine operator actuates the pedal beyond the pressure point, then the automatic NC contact is opened and the machine function is stopped.

With a mechanical bolting device, an uncontrolled restart or new start of the machine is prevented. The reset is manual by a push button on the enclosure.

All safety foot switches are mounted with a shield to protect against unintentional operation. Either one pedal or two pedal versions are available. On the two pedal version, one pedal can be used for the safety function, for example, while the other pedal can be used for a process function. The operator has the choice between different switch and contact variants, whereby there is a maximum of four contacts per pedal.

Information for the selection of suitable safety relay modules can be found in the chapter "Safety relay modules" (refer to page 220).



SWITCHING CONDITIONS

Description of the switching conditions

1. Idle state
2. Initiate the workflow by actuating to the pressure point
3. Actuating through pressure point in hazardous situations
4. Return to the idle state after mechanical unlocking

Overlapping contacts with pressure point and latching (UEDR)

Representation	Condition	Function
	Not actuated	No authorised operation
	Actuated up to pressure point	Safety release
	Pushed-through	No authorised operation
	Unlock	No authorised operation *

* Switch-on impulse during the unlocking operation must be suppressed by means of measures at control technology level.

11. SAFETY FOOT SWITCHES

OVERVIEW OF THE SERIES



TFH 232



T2FH 232

Key Features

- | | |
|---|---|
| <ul style="list-style-type: none"> ▪ With 1 foot pedal ▪ 2 or 4 contacts ▪ Enclosure in Aluminium die-cast | <ul style="list-style-type: none"> ▪ With 2 foot pedals ▪ 4, 6 or 8 contacts ▪ Enclosure in Aluminium die-cast |
|---|---|

Technical features

Electrical characteristics

Max. switching capacity U/I

230 VAC / 4 A;
24 VDC / 1 A

230 VAC / 4 A;
24 VDC / 1 A

Mechanical data

Cable entry

1 x M20

2 x M25

Cable section ¹⁾

0.75 ... 2.5 mm²

0.75 ... 2.5 mm²

Dimensions (H x W x D)

170 x 189 x 274 mm

295 x 189 x 274 mm

Ambient conditions

Ambient temperature

-25 °C ... +60 °C

-25 °C ... +60 °C

Degree of protection

IP65

IP65

Safety classification

Standards

EN ISO 13849-1

EN ISO 13849-1

B₁₀₀ NC contact

100,000

100,000

Certificates

cULus, CCC

cULus, CCC



¹⁾ Including conductor ferrules.



To get detailed information about the products and certificates, visit products.schmersal.com.

11. SAFETY FOOT SWITCHES PREFERRED TYPES



Range	Pedals	Pin assignment	Type	Material number
TFH 232 	with 1 foot pedal	1 NO / 1 NC	TFH 232-11UEDR	151181536
		2 NO / 2 NC	TFH 232-22UEDR	151192630
T2FH 232 	with 2 foot pedals	Left pedal: 1 NO / 1 NC; right pedal: 2 NO / 2 NC	T2FH 232-11/22UEDR ¹⁾	151217887
		Left pedal: 2 NO / 2 NC; right pedal: 1 NO / 1 NC	T2FH 232-22UEDR/11 ¹⁾	151217033
		Left pedal: 1 NO / 1 NC; right pedal: 1 NO / 1 NC	T2FH 232-11UEDR/11UEDR	151216987
		Left pedal: 2 NO / 2 NC; right pedal: 2 NO / 2 NC	T2FH 232-22UEDR/22UEDR	151217044

¹⁾ With the two-pedal variant, the non-safety related pedal does **not have** the functions "Overlapping" (UED) or "Latching" (R)!

Other special variants on request

12. TWO-HAND CONTROL PANELS

DESCRIPTION

AREA OF APPLICATION

The job of two-hand controls or two-hand control panels is to ensure that machine operators hands are located on the control panel when they issue the control signal for a hazardous movement. This prevents operators from reaching into the danger area on starting or shortly after starting the machine or process.

The main areas of application for two-hand controls are presses and stamping units in the metal processing or powder metallurgy industries as well as similar machines and systems that involve manual insertion and removal operations. These include printing and paper processing machines, rubber and plastics processing machines, machines involved in the chemical industry and assembly plants.

DESIGN AND WAY OF FUNCTIONING

The two-hand control panels of the Schmersal Group are mounted as standard with an EMERGENCY STOP push button to EN ISO 13850. Apart from this, there are guard hoods over the operating elements, which prevent people from circumventing the protection function using their hands, elbows, stomach, hips, thighs or knees, for example. It is also not possible to operate from the back of the control panels.

The devices comply with the requirements of EN ISO 13850, which, amongst other things, specifies the spacing of the controls. Users can choose between different versions that differ, amongst other things, by virtue of the material of the enclosure (plastic and die-cast aluminium). In the central part of the folding enclosure, it is possible to mount up to eight additional command and signalling devices.



Accessories include, amongst other things, various stand versions. Combined with the SRB-E-201ST safety relay module, it is possible to integrate two-hand control panels into the machine controller.

WIDE SELECTION OF MOUNTING POSTS

You can find appropriate mounting posts and other accessories on page 182 and in our online catalogue at products.schmersal.com.



12. TWO-HAND CONTROL PANELS OVERVIEW OF THE SERIES



SEPK02



SEPG05

Key Features

- Two-hand control panel
- Plastic enclosure
- Control panel with 8 additional drilled holes that you can knock out if required
- 2-piece enclosure for simple and favourable assembly

- Two-hand control panel
- Aluminium die cast enclosure
- Control panel suitable for mounting a minimum of 8 additional command and signalling devices
- Easy assembly thanks to 2-piece folding enclosure
- Ergonomic operation due to wrist support
- Terminal strips and relay assembly possible in the interior

Technical features

Electrical characteristics	Depends on the mounted command device	Depends on the mounted command device
Mechanical data		
Housing material	Plastic	Die-cast aluminium
Color	RAL 7035 (tinted)	RAL 7035 (powder-coated)
Dimensions (LxWxH)	469 x 137 x 185 mm	494 x 160 x 184 mm
Possible fastening		
On mounting post	■	■
Directly on the machine or wall	■	■
Command positions		
Number of drilled holes	3	3
Optional possible command positions	8	8
Ø of drilled hole	22.3 mm	22.3 mm
Ambient conditions		
Degree of protection	IP54	IP54

Safety classification

Standards	EN ISO 13850	EN ISO 13850
Certificates	–	–



You can also find appropriate mounting posts, command devices and other accessories in our online catalogue at products.schmersal.com.



SEP09

- Two-hand control
- Aluminium enclosure
- For separate assembly of the controls for two-hand control
- Specify on user side spacing according to EN ISO 13850

Depends on the mounted command device

Aluminium

RAL 7035 (powder-coated)

155 x 150 x 160 mm
(per operating element)

-

■

1 per operating element

-

22.3 mm

IP54

EN ISO 13850





-

12. TWO-HAND CONTROL PANELS PREFERRED TYPES

Range	Enclosure	Description	Controls	Head Ø	Contacts	
SEPK02 	Plastic	2-piece enclosure with 8 additional drilled holes that you can knock out if required	ADP55.3SW		55 mm	1 NO / 1 NC
			ADP55.3SW/O.F			
			Empty enclosure			
SEPG05 	Metal film	2-part enclosure suitable for mounting a minimum of 8 additional command and signalling devices	EDP42SW		42 mm	1 NO / 1 NC
			EDP55SW		55 mm	1 NO / 1 NC
			ADP55.3SW		55 mm	1 NO / 1 NC
			Empty enclosure			
SEP09 	Metal film	For separate assembly of the controls for two-hand control with detachable aluminium cover on the bottom	EDP55SW		55 mm	1 NO / 1 NC
			EDP42SW		42 mm	1 NO / 1 NC
			Empty enclosure			

For the technical data of the command devices, visit products.schmersal.com.



Emergency stop		Head Ø	Contacts	Type	Material number
ADRR40RT		40 mm	1 NO / 1 NC	SEPK02.0.4.0.22/95	101027371
				SEPK02.0.4.0.22/95.E2	101211126
				SEPK02.0.L.22	101027369
EDRR40RT		40 mm	1 NO / 1 NC	SEPG05.3.3.0.22/95	101172764
EDRR50RT		50 mm	1 NO / 1 NC	SEPG05.3.2.0.22/95	101172762
EDRR40RT		40 mm	1 NO / 1 NC	SEPG05.3.4.0.22/95	101172765
EDRR50RT		50 mm	1 NO / 1 NC	SEPG05.3.1.0.22/95	101172760
EDRR40RT		40 mm	1 NO / 1 NC	SEPG05.3.4.0.22/95.E1	101210845
				SEPG05.3.L.22	101172767
				SEP09.0.1.0.22/95	101022849
				SEP09.0.3.0.22/95	101022851
				SEP09.0.L.22	101022856

12. TWO-HAND CONTROL PANELS MOUNTING POST



STPLC1	101024774	STP02.1.1	101022865	STP02.4.1	101022867
 <ul style="list-style-type: none"> ■ Welded structure with base-fastening tapped holes ■ Without height adjustment, without distance ring ■ Can be combined with SEP ... control panel for use as a two-hand foot operating station 	 <ul style="list-style-type: none"> ■ Welded structure with base-fastening tapped holes ■ With height adjustment, without distance ring 	 <ul style="list-style-type: none"> ■ Welded structure with base-fastening tapped holes ■ With height adjustment, with distance ring 			

12. TWO-HAND CONTROL PANELS RECOMMENDED EVALUATIONS



SRB-E-201ST



- Monitoring two-hand control panels to EN ISO 13850
- Function STOP 0
- 1- or 2-channel control
- Start button / autostart
- 2 safety outputs 5.5 A
- 1 signalling output
- For more information, visit products.schmersal.com

SRB-E-402ST



- Monitoring two-hand control panels to EN ISO 13850
- 2x function STOP 0
- 2x 1- or 2-channel control
- 2x start button / autostart
- 2 safety contacts
- 2 safety outputs
- For more information, visit products.schmersal.com

PROTECT PSC1



- Safety controller
- For more information, visit www.psc1.de

13. SAFETY EDGES DESCRIPTION

AREA OF APPLICATION

Tactile monitoring systems stop the hazardous movement in case of contact or when touched. The variety of application fields require different safety devices.

Everywhere, where the risk of injury from crushing and sheering needs to be safe-guarded against, be it on safety doors, table lifts, lifting platforms, portable rack storage, work benches, warehouse lifts, elevator doors, access ramps, lifting and tilting devices or even industrial doors. The SE-safety edge stops the hazardous movement safely and reliably and prevents injury to persons and damage to machinery.

The systems described, each with an appropriate downstream evaluation device reach the safety requirements of the EN ISO 13849-1 to the Performance Level PL c, PL d or PL e.

DESIGN AND WAY OF FUNCTIONING

By design, the SE-safety edge is made of only three components; the aluminium profile rail, the rubber profile and the pluggable sensors.

The deformation of the rubber profile safety edge is evaluated. The centrepiece is a fail-safe transmitter and receiver unit in both ends of the rubber profile. The deformation of the rubber profile strip weakens or interrupts the IR-signal between the transmitter and receiver units. A downstream safety relay module evaluates this weakening of the IR-signal without interference and stops the hazardous movement.

The EN ISO 13856-2 summarises the requirements for safety edges and describes their design and evaluation. Safety-related properties, such as operating temperature ranges, response times, forces, operating distances and stopping distances are defined in this Standard.

EN ISO 13849-1 describes the design principles for safety-related parts of control systems.

The risk when using a mobile machine or equipment must be determined. The requirements on the safety of the controller increases the higher the risk.

The SE-safety edge system with the safety relay module SE-400C complies with the requirements of the PL e. The safe shutdown of the switch strip system is also reliable even when several faults occur in the system.

The SE-safety edge system with the safety relay module SE-304C complies with the requirements of the PL d.

For PL c applications in accordance with EN ISO 13849-1 the SE-switch strip can be used also with the safety relay module SE-100C.



When implementing the switch strip it must be taken into account that the speed of the hazardous movement is lower than the maximum starting speed of the switch strip. The stopping distance of the potentially dangerous parts and the profile-specific data must be adapted to each another. The stopping distance must not only be sufficient to bring the machine in the worst case situation to a standstill, but the maximum allowable force for vulnerable body parts must not be exceeded. Attention must be made during the planning to the counter-edge. If the possible run-on distance of the selected switch strip is not sufficient, the stopping distance of the machine must be shortened or a different switch strip profile should be used.

The required minimum run-on distance must be designed with the safety factor of at least 1.2. The safety factor must be even greater as soon as the run-on distance is influenced by other machine elements. (See also EN ISO 13856-2 Annex C.)

13. SAFETY EDGES

OVERVIEW OF THE SERIES



■ SE40



■ SE70

Key Features

- Height approx. 40 mm
- Insensitive to Ambient conditions
- Dirt and moisture in the profile are compensated to a great extent

- Height approx. 70 mm
- Insensitive to Ambient conditions
- Dirt and moisture in the profile are compensated to a great extent

Technical features

Material of the rubber profile	EPDM, 65 Shore A; NBR Perbunan®	EPDM, 65 Shore A; NBR Perbunan®
Rubber material		
- International abbreviation	EPDM, 65 Shore A	EPDM, 65 Shore A
- Chemical name	Ethylene-propylene terpolymer	Ethylene-propylene terpolymer
- Rebound resilience at 20 °C	good	good
- Resistance to permanent deformation	good	good
- General weather resistance	excellent	excellent
- Resistance against ozone	excellent	excellent
- Resistance against oil	low	low
- Resistance against fuel	low	low
- Resistance against solvents	low to satisfactory	low to satisfactory
- General resistance to acids	good	good
Mechanical data		
Mechanical life	20,000,000 operations	20,000,000 operations
Max. permanent load	500 N on the operational switching zone	500 N on the operational switching zone
Response travel	max. 9 mm	max. 9 mm
After-travel	max. 20 mm	max. 45 mm
Dimensions (W x H)	25 x 40 x ... mm	25 x 70 x ... mm
Ambient conditions		
Temperature resistance		
- Short term	-50 °C ... +120 °C	-50 °C ... +120 °C
- Long term	-40 °C ... +100 °C	-40 °C ... +100 °C
Degree of protection ¹⁾	IP67	IP67

Safety classification

Standards	EN ISO 13856-2	EN ISO 13856-2
Certificates ²⁾	TÜV	TÜV

¹⁾ The IP67 degree of protection applies to the complete signalling devices (including SE-SET).

²⁾ Certification only in conjunction with safety relay modules SE-100C, SE-304C or SE-400C. Plastic-coated and NBR-profiles are not part of the type tests.



To get detailed information about the products and certificates, visit products.schmersal.com.

13. SAFETY EDGES

PREFERRED TYPES



Type	Series	Special features	Type	Material number	
Aluminium profile	SE40	Without aluminium leg	SE-AL10-1250	101153893	
		With aluminium leg	SE-AL10-2500	101172179	
	SE70	Without aluminium leg	SE-AL12-1250	101153894	
		With aluminium leg	SE-AL12-2500	101172180	
		Without aluminium leg	SE-AL20-1250	101153895	
		With aluminium leg	SE-AL20-2500	101172186	
Rubber profile	SE40	Uncoated EPDM rubber profile	SE-P40-1250	101172155	
			SE-P40-2500	101172154	
			SE-P40-5000	101172153	
			SE-P40-10000	101172151	
		Uncoated NBR rubber profile	SE-P40-NBR-1250	101174453	
			SE-P40-NBR-2500	101174454	
	SE-P40-NBR-5000		101174455		
	SE-P40-NBR-10000		101174456		
	SE70	Uncoated EPDM rubber profile	SE-PC40-1250	101172161	
			SE-PC40-2500	101172159	
		Coated EPDM rubber profile	SE-P70-1250	101172169	
			SE-P70-2500	101172168	
			SE-P70-5000	101172167	
			SE-P70-10000	101172165	
	SE-SET	SE40/70	Set of transmitter and receiver with different cable lengths	SE-PC70-1250	101172173
				SE-PC70-2500	101172172
				SE-SET VER.2.0	101179375
			SE-SET VER.2.0 3M/10,5M	101179373	
SE-SET VER.2.0 10,5M/20M			101181969		
Safety monitoring module			SE40/70	Evaluation of 1 ... 2 switch strips PL c	SE-100C
	Evaluation of 1 ... 4 switch strips PL d	SE-304C		101165883	
	Evaluation of 1 switch strip PL e	SE-400C		101153920	

A switch strip system is assembled from individual components. The components must be ordered separately.

Ordering example

A **SE40-System** consists of:

- ① Rubber profile, SE-P40-1250
- ② Aluminium profile, SE-AL 10-1250
- ③ Transmitter / receiver SE-SET
- ④ Safety relay module, SE-304 C

Optional accessories:
End cap SE-T40; adhesive SE-G8406
or further accessories

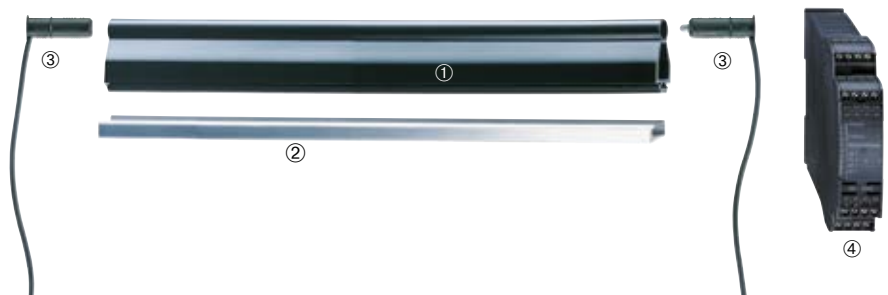

13. SAFETY EDGES

SYSTEM COMPONENTS



<p>SE-P40...</p>  <ul style="list-style-type: none"> ■ Rubber profile available either coated or uncoated ■ EPDM and NBR rubber available ■ Available lengths: 1,250, 2,500, 5,000 and 10,000 mm (other lengths on request) 	<p>SE-P70...</p>  <ul style="list-style-type: none"> ■ Rubber profile available either coated or uncoated ■ EPDM and NBR rubber available ■ Available lengths: 1,250, 2,500, 5,000 and 10,000 mm (other lengths on request) 	<p>SE-AL10-....</p>  <ul style="list-style-type: none"> ■ Aluminium profile section for rubber profile SE-P40... ■ Available lengths: 1,250 and 2,500 mm (larger lengths by joining multiple AL-profiles)
<p>SE-AL12-....</p>  <ul style="list-style-type: none"> ■ Aluminium profile with aluminium legs for rubber profile SE-P40... ■ Available lengths: 1,250 and 2,500 mm (larger lengths by joining multiple AL-profiles) 	<p>SE-AL20-....</p>  <ul style="list-style-type: none"> ■ Aluminium profile section for rubber profile SE-P70... ■ Available lengths: 1,250 and 2,500 mm (larger lengths by joining multiple AL-profiles) 	<p>SE-AL22-....</p>  <ul style="list-style-type: none"> ■ Aluminium profile with aluminium legs for rubber profile SE-P70... ■ Available lengths: 1,250 and 2,500 mm (larger lengths by joining multiple AL-profiles)
<p>SE-SET</p>  <ul style="list-style-type: none"> ■ Sensor set consisting of transmitter and receiver ■ Different cable lengths available 		

To get detailed information about the products and certificates, visit products.schmersal.com.

13. SAFETY EDGES ACCESSORIES



SE-T40 101167876	SE-T70 101167879	SE-J2 101188728
<div style="text-align: center;">  </div> <ul style="list-style-type: none"> ■ End plugs for SE40 ■ Uncoated (coating on request) 	<div style="text-align: center;">  </div> <ul style="list-style-type: none"> ■ End plugs for SE70 ■ Uncoated (coating on request) 	<div style="text-align: center;">  </div> <ul style="list-style-type: none"> ■ Connection box M16
SE-CC 130.	SE-G 8406 101175392	SE-SC 101153923
<div style="text-align: center;">  </div> <ul style="list-style-type: none"> ■ Coiled cable ■ Length 1 m extendable to 3 m ■ Cable section <ul style="list-style-type: none"> 4 x 0.25 mm²: SE-CC 1301 101158587 5 x 0.50 mm²: SE-CC 1302 101158588 	<div style="text-align: center;">  </div> <ul style="list-style-type: none"> ■ Cyanoacrylate adhesive 	<div style="text-align: center;">  </div> <ul style="list-style-type: none"> ■ Rubber scissors
SE-PR 101175381		
<div style="text-align: center;">  </div> <ul style="list-style-type: none"> ■ Primer ■ Amount: 5 ml 		

To get detailed information about the products and certificates, visit products.schmersal.com.

13. SAFETY EDGES

SAFETY MONITORING MODULES



■ SE-100C



■ SE-304C

Key Features

- | | |
|--|--|
| <ul style="list-style-type: none"> ▪ To monitor 1 ... 2 safety edges ▪ 1 safety contact, STOP 0 ▪ 1 signalling output | <ul style="list-style-type: none"> ▪ To monitor 1 ... 4 safety edges ▪ 1 safety contact, STOP 0 ▪ 1 signalling output |
|--|--|

Technical features

Electrical data	SE-100C	SE-304C
Operating voltage	24 VDC +20 % / -10 %	24 VDC +20 % / -10 %; 24 VAC +10 % / -10 %
Operating current	approx. 150 mA	approx. 500 mA (for 4 safety edges)
Electronic fuse	■	■
Power consumption	< 4 W	< 4 W
Pull-in delay with reset button	-	100 ms ... 2000 ms
Response time	16 ms	< 17 ms
Max. switching capacity of the safety contacts U/I	230 VAC / 2 A; 24 VDC / 2 A	230 VAC / 2 A; 24 VDC / 2 A
Mechanical data		
With removable terminals	-	-
Dimensions (H x W x D)	22.5 x 120 x 100 mm	22.5 x 121 x 100 mm
Ambient conditions		
Ambient temperature	-5 °C ... +55 °C	-5 °C ... +55 °C

Safety classification

Standards	SE-100C	SE-304C
PL	c	d
Control category	1	3
PFH	$2.24 \times 10^{-6}/h$	$1.01 \times 10^{-7}/h$
Certificates	TÜV, cULus	TÜV



To get detailed information about the products and certificates, visit products.schmersal.com.



■ SE-400C

- To monitor 1 safety edge
- 2 safety contacts, STOP 0
- 1 signalling output

24 VDC +20 % / -10 %

approx. 150 mA

■
< 4 W

-

32 ms

230 VAC / 2 A;
24 VDC / 2 A

-

22.5 x 120 x 100 mm

-5 °C ... +55 °C

EN ISO 13849-1

e

4

$2.47 \times 10^{-8}/h$

TÜV, cULus

14. SAFETY MATS

DESCRIPTION

AREA OF APPLICATION

Tactile protection equipment such as safety mats are used to make hazardous working areas around machinery and equipment safe. This ensures personal safety in hazardous areas.

In contrast to optoelectronic protection equipment such as safety light curtains, safety mats allow the monitoring of entire working areas and not only the access areas. Therefore we speak here of zone protection. They are also insensitive to external influences such as dust and chips.

Common uses of safety mats are, for example, the protection of hazardous areas at woodworking machines, scissor lift tables, punching machines and pipe bending machines.

DESIGN AND WAY OF FUNCTIONING

A safety mat consists of two separate conducting metal plates. Insulating layers separate the plates from each other. If someone steps onto the safety mat, an electrical short-circuit occurs between the metal plates. The connected safety relay module analyses this signal and switches the hazardous movement off.

In this way, a sheet-like protective device can be used for the detection of persons. Arranging several safety mats together allows large hazardous areas to be quickly and easily made safe. Four different standard sizes are available. In addition, special sizes and shapes can be made available upon request .

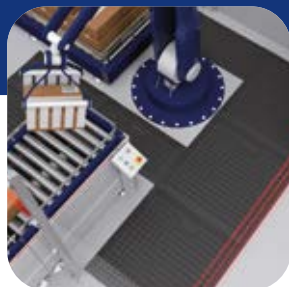
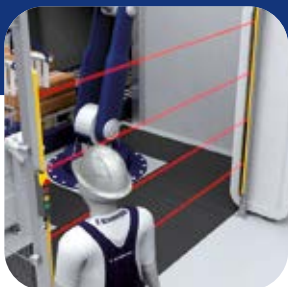

The Schmersal range of products includes two series of safety mats. The Series SMS 4, which is fixed to the ground using an aluminium profile and special corner connectors. The chamfered profile shape prevents any risk of tripping. The aluminium profile is additionally used as edge protection, if the area is used with forklifts or other vehicles. The Series SMS 5 has a moulded polyurethane approach profile.

Both series are characterised by a very robust design and high resistance to acids, alkalis, oil, and gasoline. In connection with the safety relay modules SRB301HC (page 229), SRB-E-301ST (page 229) or a PROTECT SELECT (OEM) (page 246) they meet the requirements of the Performance Level (PL) d according to EN ISO 13849-1.

SAFETY DISTANCE

The correct arrangement of the safety mat with regard to the adjacent hazardous area mainly depends on the after-travel time of the machine and the approaching speed of the operator. The standard EN ISO 13855 (Safety of Machinery, Approaching Speed of Body Members) provides a formula to calculate the safety distance.

14. SAFETY MATS

OVERVIEW OF THE SERIES



■ SMS 4



■ SMS 5

Key Features

- Surface material out of black polyurethane
- Robust design
- Special sizes are available on request
- Without border
- 4 wire line connection

- Surface material out of black polyurethane
- Robust design
- Special sizes are available on request
- With moulded ramp profile
- 2 x 2 wire line connection

Technical features

Electrical characteristics		
Execution of the electrical connection	Cable	Cable
Cable section	4 x 0.34 mm ²	2 x 2 x 0.34 mm ²
Mechanical data		
Permissible load	2,000 N/cm ² with round body Ø 80 mm	2,000 N/cm ² with round body Ø 80 mm
Actuating force	150 N with round body Ø 80 mm	150 N with round body Ø 80 mm
Inactive area	≤ 10 mm	≤ 10 mm
Chemical resistance		
Water	Resistant	Resistant
10 % Acids	Resistant	Resistant
10 % Alkalis	Resistant	Resistant
Oils	Resistant	Resistant
Petroleum	Resistant	Resistant
Ambient conditions		
Ambient temperature	0 °C ... +60 °C	0 °C ... +60 °C
Degree of protection	IP65	IP65

Safety classification ¹⁾

Standards	EN ISO 13849-1; EN ISO 13856-1	EN ISO 13849-1; EN ISO 13856-1
PL/ SIL	d/2	d/2
Control category	3	3
PFH	4.2 x 10 ⁻⁸ /h	4.2 x 10 ⁻⁸ /h
Certificates	TÜV, cULus	TÜV, cULus





¹⁾ Only in connection with safety modules SRB301HC/R and SRB301HC/T.

To get detailed information about the products and certificates, visit products.schmersal.com.

14. SAFETY MATS

PREFERRED TYPES AND ACCESSORIES



Range	Active area	Type	Material number	
SMS 4		250 x 500 mm	SMS 4-250-500	101208365
		500 x 500 mm	SMS 4-500-500	101208366
		500 x 750 mm	SMS 4-500-750	101210174
		500 x 1000 mm	SMS 4-500-1000	101208367
		750 x 1000 mm	SMS 4-750-1000	101208368
		1000 x 1000 mm	SMS 4-1000-1000	101208369
		1000 x 1500 mm	SMS 4-1000-1500	101208370
SMS 5		250 x 500 mm	SMS 5-250-500	101208371
		500 x 500 mm	SMS 5-500-500	101208372
		500 x 1000 mm	SMS 5-500-1000	101208373
		700 x 800 mm	SMS 5-700-800	101211564
		750 x 1000 mm	SMS 5-750-1000	101208374
		1000 x 1000 mm	SMS 5-1000-1000	101208375
		1000 x 1500 mm	SMS 5-1000-1500	101208376

SMS 4-BS-3000	101208378	SMS 4-RS-3000	101209478	SMS 4-EV	101208379
					
<ul style="list-style-type: none"> ■ Mounting rail ■ Length 3000 mm 		<ul style="list-style-type: none"> ■ Ramp rail ■ Length 3000 mm 		<ul style="list-style-type: none"> ■ Corner section ■ Included in delivery 1 unit 	

15. OPTOELECTRONIC SAFETY DEVICES

DESCRIPTION

USAGE / SELECTION OF AOPD

In order to choose the appropriate active optoelectronic protective device (AOPD) such as light barriers or light curtains/grids to use them correctly, both the requirements of the standards (EN ISO 13849-1, EN ISO 13855, C standards etc.) and product-specific features (detection sensitivity, range, etc.) must be taken into account.

AOPD's can be used, provided that:

- The dangerous movement can be stopped at all times and that it is ensured that the dangerous area can only be reached after the movement has come to standstill.
- The stopping times of the machine and all safety components used are known.
- No objects (work pieces, liquids, etc.) can be ejected.
- The AOPD meet the requirements of Type 2 or Type 4 acc. to EN 61496.
- The dangerous area can only be reached by passing through the protected field of the AOPD.
- Reaching over, under or through the protected field is impossible.
- The start or restart command devices are fitted in such a way that the entire hazardous area is completely visible from the outside and it cannot be activated from within the hazardous area.
- The safety distance is calculated and constructively applied in accordance with EN ISO 13855.

The effectiveness of the protection equipment is only as good as the risk analysis carried out when designing the system, which took into consideration all the marginal conditions such as surroundings, machine and functional sequences.

SAFETY LIGHT GRIDS AND CURTAINS

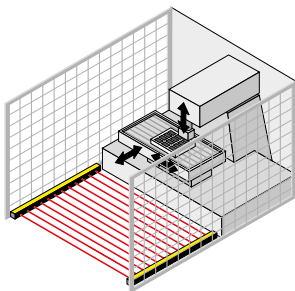

The safety light curtains and safety light grids of the SLC and SLG range meet the requirements of Category type 2 and type 4 according to EN 61496. Typical applications for safety light barriers are on robots, automatic-processing plants, transfer lines, rack storage and pallet loaders. If the light beam is interrupted by an object or a person, a stop signal is emitted to bring the machine to a standstill.

The protection field is defined by the height and width of the protection field. The protected height is the range between the first and last infrared light beam of a light curtain. The protected width or operating range is the distance between the emitter and receiver unit. If the light beam is interrupted, a signal is emitted to bring the dangerous movement of the machine to a standstill.

For the detection of body parts, a distinction is made between finger, hand and body protection. EN ISO 13855 sets the biometric data for finger protection to 14 mm, for hand detection to 30 mm, for leg detection up to 70 mm and for body detection to over 70 mm. Safety light grids are generally used to detect the penetration of the entire human body.

The safety light grids and light curtains can be smoothly connected through a M12 connector; they are equipped with a diagnostic interface as well as an LED for status indication. The safety light curtains or light grids feature an integrated safety-monitoring module with start/restart interlock and contactor control. Additional functions such as blanking, muting and a synchronisation function for the light curtains are also available.

Today with Bluetooth® LE an innovative communication interface is available for the diagnosis and inspection of AOPD. The current AOPD data of the SLC440 and SLC440COM series are displayed in real time.



SAFETY LIGHT CURTAINS WITH BLUETOOTH® INTERFACE BLE

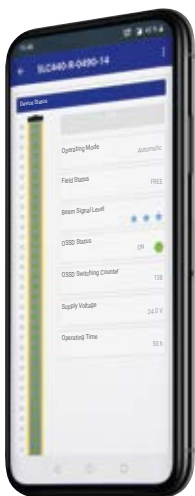

"SLC Assist" for iOS



"SLC Assist" for Android



The App "SLC Assist"

The App gives information about

- Operating mode
- Beam signal level
- OSSD status
- Status of the protective field
- Number of OSSD switches
- Supply voltage
- Operating time

Beam signal level:

★★★ = perfect alignment

☆☆☆ = optimisation required

You will define the service cycles for the safety relay module via the OSSD switching counter. The information of the total operating time is the basis for planning the periodic inspection.

Innovative Technology

The light curtain with Bluetooth® interface and the Schmersal App gives optimal support for

- Condition monitoring
- Optimal alignment
- Preventive maintenance
- Documentation according to industrial safety regulations

The Schmersal App "SLC Assist" is available for Android and iOS devices.

More information can be found in the product video.

Product video:



15. OPTOELECTRONIC SAFETY DEVICES

MODES OF OPERATION AND FUNCTIONS

SAFETY LIGHT BARRIERS

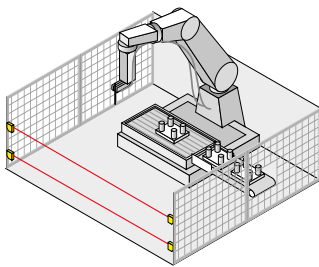

All SLB photoelectric barriers have fail-safe integrated semi-conductor outputs (2 x PNP) and can be incorporated directly in the safety circuit without external safety monitoring. The new product family meets the requirements of all type 2 or type 4 applications in accordance with EN 61496. The safety photoelectric barriers are distinguished by extremely small dimensions which means that they can be well placed in the surrounding structure and can also be mounted easily and quickly even in tight spaces. Both models have a range of 15 metres. The SLB 440...-H model features a range of up to 75 metres and, as an option, has integrated heating for use in minus temperatures.

Single beam photoelectric barriers are particularly suitable for safeguarding smaller hazardous areas – such as machines with small openings or slots.

With this set of features, the new photoelectric barriers can be deployed in numerous ways – for example in work areas where assembly and material handling technology is used as well as in the wood, paper and print industry. Other areas of application are (semi) automated shelving and commissioning systems, high shelf warehouses and packaging machines as well as for confining work areas of man and machine. It can also be used in outside areas, for example in the wood and cement industry, in gravel pits or in harbours/ports.

OPERATING MODES



Double reset

The operating modes of an AOPD must be defined according to the risk analysis of a machine.

Automatic / Protective mode

The protective mode switches the AOPD outputs to an ON state (protection field not interrupted), without external release of a switching device. This mode of operation creates an automatic machine restart if the protection field is not interrupted and should only be selected with the restart interlock of the machine.

Restart interlock (manual reset)

The restart interlock (manual reset) prevents an automatic enabling of the outputs (OSSD's ON state) after switch-on of the operating voltage or an interruption of the protection field. The system switches the outputs only to an ON state, when an external command device generates an enabling signal at the restart input (receiver).

Restart interlock with double acknowledgement/reset

In applications with access monitoring, a complete overview of the hazardous areas is often not possible; despite that, a reset of the command device for the restart interlock outside of the hazardous area by third parties is enabled at all times. This hazardous situation of an unexpected start-up can be avoided by means of a double reset, i.e. integration of one command device inside and one outside the hazardous area.

Setting mode

Before commissioning an AOPD, the best possible alignment of the sensors should be determined. The set-up mode visualises the set-up quality during the installation of the sensors. Visualisation is via a 7-segment display, a status display or optionally via a smartphone with the "SLC Assist" app.

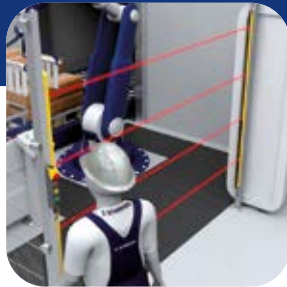

OBJECT BLANKING

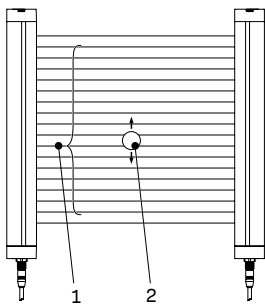

- 1 Object blanking area
- 2 Movable object

For safe production, object blanking can be used to blank just part of the protection field. This makes it possible to add objects, e.g. workpieces, or position a conveyor belt with a fixed position in the protection field.

With integrated movable object blanking (floating blanking) of the SLC440/445 light curtains, up to 2 light beams of the light curtain can be blanked flexibly. This function is required if there is a need to be able to interrupt light beams in the protection field at a position that is not specifically defined.

Different blanking functions are available. The distinguishing feature of the different modes is the number of light beams that can be interrupted by an object. In addition to that, it can be defined whether the object may be in the protection field permanently or only temporarily. The interrupted light beams can be at any position in the protection field.

MUTING

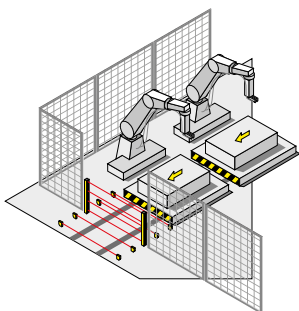

If goods or objects need to be transported in or out of the hazardous area without stopping the machine, the safety light curtain must be automatically and temporarily suspended. Two or four muting signals are used to detect whether a person is approaching the hazardous area or a transport system is entering or leaving the hazardous area. Suitable muting inputs are light barriers, proximity switches or position switches.

The integrated safety-muting controller of the safety light curtain or light grid monitors and controls the muting process. The safety outputs are not disabled. Depending on the application, different light barriers with integrated muting functions are available.

15. OPTOELECTRONIC SAFETY DEVICES

SAFETY DISTANCE

SAFETY DISTANCE

The stopping time for the complete system and the resolution capacity of the AOPD essentially determines the required safety distance of the AOPD to the dangerous area. The safety light grid or light curtain must be sized and installed so that a stop signal would be transmitted and the hazard ceased prior to a person or a body part accessing the danger zone.

The standard EN ISO 13855 provides the user with detailed information about the calculation of the minimum safety distances. These include the following important influencing factors:

- Stopping time of the entire system, taking the different reaction times of the individual systems into account (e.g. machine, safety relay module, AOPD etc.)
- Detection capability of the AOPD to detect body parts (finger, hand and whole body)
- Arrangement of each protection device in the normal position (vertical mounting), parallel orientation (horizontal mounting) or at any angle in front of the guard system
- Approach speed to the protection field

For the calculation of the minimum safety distance **S** to the hazardous area, EN ISO 13855 presents the following general formula:

$$S = K \times T + C$$

Key:

S the safety distance to the hazardous area (mm)

K the approach speed of the body or the body part (mm/s)

T total reaction time of the system (s)
(inc. machine run-on time, reaction time of the safety guard and the safety relay module, etc.)

C additional distance (mm) before the safety guard

If access to the hazardous area (by passing across the protection field) cannot be excluded by using vertically mounted contactless protective equipment such as a light grid, an additional minimum distance CRO should be considered.

This distance is dependent on the protection field height above the ground and the position of the hazardous area (EN ISO 13855).

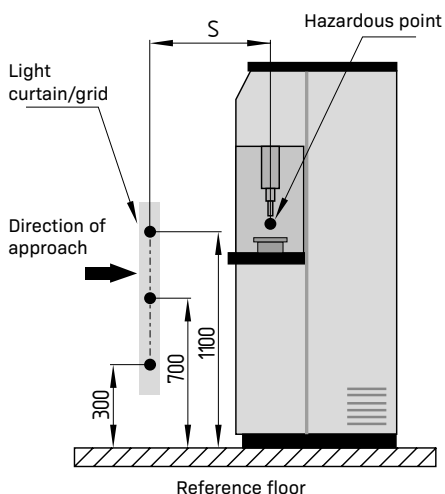

15. OPTOELECTRONIC SAFETY DEVICES OVERVIEW

Selection	Type to EN 61496	Special features	Series	refer to
Safety light barriers SLB	Type 2	Range to 15 m	SLB240	Page 202
	Type 4	Range to 15 m	SLB440	
		Range to 75 m	SLB440-H	
Safety light curtains SLC	Type 2	Compact	SLC240COM	Page 204
	Type 4	Included in standard version	SLC420	Page 206
		Master / Slave	SLC420 M/S	
		Compact	SLC440COM	Page 210
		High degree of protection	SLC440COM – PH enclosure	
		Included in standard version	SLC440	
		High degree of protection	SLC440 – SH/PH enclosure	
	Multifunctional	SLC445		
Type 2	Compact	SLG240COM	Page 204	
Safety light grids SLG	Type 4	Included in standard version	SLG420	Page 206
		Active-passive system with mirror	SLG422-P	
		Compact	SLG440COM	Page 210
		High degree of protection	SLG440COM – PH enclosure	
		Included in standard version	SLG440	
		High degree of protection	SLG440 – SH/PH enclosure	
		Multifunctional	SLG445	

15. SAFETY LIGHT BARRIERS

RANGE SLB – OVERVIEW



Key Features

- | | | |
|---|---|--|
| <ul style="list-style-type: none"> ▪ Safety light barrier type 2 ▪ 4-stage coding ▪ Integr. evaluation | <ul style="list-style-type: none"> ▪ Safety light barrier type 4 ▪ 4-stage coding ▪ Integr. evaluation | <ul style="list-style-type: none"> ▪ Safety light barrier type 4 ▪ 4-stage coding ▪ Integr. evaluation ▪ Optional heater |
|---|---|--|

Technical features

Range of the protection field	15 m	15 m	75 m
Min. object size	Ø 10 mm	Ø 10 mm	Ø 70 mm
Wave length of the sensors	880 nm	880 nm	880 nm
Electrical characteristics			
Response time	7 ... 22 ms	7 ... 22 ms	7 ... 22 ms
Automatic/restart interlock	■	■	■
Rated operating voltage U_e	24 VDC ± 10 %	24 VDC ± 10 %	24 VDC ± 10 %
Safety outputs	2 x OSSD	2 x OSSD	2 x OSSD
Mechanical data			
Material of the housings	Aluminium	Aluminium	Aluminium
Termination	ST: Connector plug M12 LST: 20 cm Cable with connector M12	ST: Connector plug M12 LST: 20 cm Cable with connector M12	ST: Connector plug M12 LST: 20 cm Cable with connector M12
Connector plug (transmitter/receiver)	4-pole / 5-pole	4-pole / 5-pole	4-pole / 5-pole
Cable length	Max. 100 m	Max. 100 m	Max. 100 m
Dimensions (H x W x L)	ST: 28 x 91 x 33 mm LST: 28 x 72 x 33 mm	ST: 28 x 91 x 33 mm LST: 28 x 72 x 33 mm	ST: 28 x 131 x 33 mm LST: 28 x 111 x 33 mm
Ambient conditions			
Ambient temperature	-30 °C ... +50 °C	-30 °C ... +50 °C	-30 °C ... +50 °C
Degree of protection	IP67	IP67	IP67
Recommended safety-monitoring module for the series wiring	SRB-E-204ST	SRB-E-204ST	SRB-E-204ST

Safety classification



Standards	EN ISO 13849-1 EN 62061	EN ISO 13849-1 EN 62061	EN ISO 13849-1 EN 62061
PL/SIL	c/2	e/3	e/3
Control category	2	4	4
PFH	1.5 x 10 ⁻⁹ /h	1.5 x 10 ⁻⁸ /h	1.5 x 10 ⁻⁸ /h
Certificates	TÜV, UL	TÜV, UL	TÜV, UL





To get detailed information about the products and certificates, visit products.schmersal.com.

15. SAFETY LIGHT BARRIERS

RANGE SLB – PREFERRED TYPES AND ACCESSORIES

Type	Range	Type	Termination	Type	Material number	
Safety light barriers	SLB240		Coding 1*	Connector plug	SLB240-ER-1-ST	103013801
				Cable with connector	SLB240-ER-1-LST	103013529
	SLB440		Coding 1*	Connector plug	SLB440-ER-1-ST	103019521
				Cable with connector	SLB440-ER-1-LST	103013525
	SLB440-H		Coding 1*	Connector plug	SLB440-ER-1-ST-H	103015483
				Cable with connector	SLB440-ER-1-LST-H	103015487
				Connector plug	SLB440-ER-1-ST-H-EH	103015491
				Cable with connector	SLB440-ER-1-LST-H-EH	103015497

*Other coding available.

Connector	KA-0977	103013625	MS-...
 <ul style="list-style-type: none"> ■ Connector M12, straight, 4 pole <ul style="list-style-type: none"> 5 m KA-0804 10 m KA-0805 20 m KA-0808 ■ Connector M12, straight, 5 pole <ul style="list-style-type: none"> 5 m A-K5P-M12-S-G-5M-BK-2-X-A-1 10 m A-K5P-M12-S-G-15M-BK-2-X-A-1 	 <ul style="list-style-type: none"> ■ Parametrisation cable for SLB series ■ Y-splitter, M12, 5-pole with P-button 	 <ul style="list-style-type: none"> ■ Assembly sets for SLB series <ul style="list-style-type: none"> ■ For SLB240 / SLB440 (qty. 2 brackets, qty. 4 screws) MS-1101 ■ For SLB440-H (qty. 4 brackets, qty. 8 screws) MS-1100 	

SMA-80	101150262	BF-SMA-80-1	101150263	BF-SMA-80-2	101150264
 <ul style="list-style-type: none"> ■ Tilted mirror for SLB series <ul style="list-style-type: none"> ■ Height: 80 mm ■ Width: 120 mm 	 <ul style="list-style-type: none"> ■ Mounting bracket for attachment of tilted mirror SMA-80 (horizontal tilt) 	 <ul style="list-style-type: none"> ■ Mounting bracket for attachment of tilted mirror SMA-80 (vertical tilt) 			

Detailed information for the selection of accessories can be found at products.schmersal.com.

16. SAFETY LIGHT GRIDS AND CURTAINS

TYPE 2 – RANGE 240COM – OVERVIEW



■ SLC240COM



■ SLG240COM

Key Features

- Safety light curtain
- Compact

- Safety light grid
- Compact

Technical features

Resolution	14, 30, 35 mm	300, 400 or 500 mm
Protection heights	330 mm ... 1930 mm	500, 800 or 900 mm
Number of beams	11 ... 192	2, 3 or 4 beams
Range of the protection field	0.3 ... 12 m	0.3 ... 12 m
Operating modes		
- Protective mode / Automatic	■	■
- Restart interlock (manual reset)	■	■
- Parameter setting	KA-0896	KA-0896
Functions integrated		
- Contactor control	-	-
- Blanking of objects	■	■
- Muting	-	-
- Cyclic function	-	-
- Further functions (see key)	DM, RS	DM, RS
Electrical characteristics		
Operating voltage	24 VDC ± 10 %	24 VDC ± 10 %
Safety output OSSD, 24 VDC	2 x PNP (timing)	2 x PNP (timing)
Response time OSSD	10 ... 28 ms	10 ms
Switching capacity OSSD	500 mA	500 mA
LED status display, 7-segment display	Status display	Status display
Mechanical data		
Execution of the electrical connection	Connector	Connector
Connector plug (transmitter/receiver)	4-pole / 5-pole	4-pole / 5-pole
Dimensions ¹⁾	27.8 x 33 mm	27.8 x 33 mm
Ambient conditions		
Ambient temperature	-10 °C ... +50 °C	-10 °C ... +50 °C
Degree of protection	IP67	IP67

Safety classification

Standards	EN ISO 13849-1, EN 62061	EN ISO 13849-1, EN 62061
PL/SIL	c/1	c/1
Control category	2	2
PFH	8.05 x 10 ⁻⁹ /h	8.05 x 10 ⁻⁹ /h
Certificates	TÜV, UL, EAC	TÜV, UL, EAC



Type to EN 61496	Type	Range	Resolution	Protection heights	Range	Type	Material number
Type 2	Safety light curtain SLC	SLC240COM	14 mm	330 ... 1930 mm	0,3 ... 7 m	SLC240COM-ER-xxxx-14	---
			30 mm	330 ... 1930 mm	0.3 ... 12 m	SLC240COM-ER-xxxx-30	---
			35 mm	330 ... 1930 mm	0,3 ... 7 m	SLC240COM-ER-xxxx-35	---
	Safety light grids SLG	SLG240COM	2 beams	500 mm	0.3 ... 12 m	SLG240COM-ER-0500-02	103016120
			3 beams	800 mm	0.3 ... 12 m	SLG240COM-ER-0800-03	103016122
			4 beams	900 mm	0.3 ... 12 m	SLG240COM-ER-0900-04	103016127

xxxx = For different heights and other combinations, see products.schmersal.com.

--- = The material number is dependent on the protective field heights.

¹⁾ The height depends on the protection field height.

Key

BC = Beam coding
DQ = Double acknowledgement/reset
MS = Multiple scan
DM = Setting mode
SI = Start interlock
RS = Series-wiring

To get detailed information about the products and certificates, visit products.schmersal.com.

16. SAFETY LIGHT GRIDS AND CURTAINS

TYPE 4 – RANGE 420/422 – OVERVIEW



■ SLC420



■ SLC420 M/S

Key Features

- Safety light curtain
- Standard

- Safety light curtain
- Master/Slave

Technical features

Resolution	14, 30, 50 mm	14, 30, 50 mm
Protection heights	170 mm ... 1770 mm	170 mm ... 2420 mm
Number of beams	2 ... 144	4 ... 208
Range of the protection field	0.3 ... 18 m	0.3 ... 18 m
Operating modes		
- Protective mode / Automatic	■	■
- Restart interlock (manual reset)	■	■
- Parameter setting	NSR-0801 (adapter)	NSR-0801 (adapter)
Functions integrated		
- Contactor control	■	■
- Blanking of objects	■	■
- Muting	-	-
- Cyclic function	-	-
- Further functions (see key)	BC, SI	BC, SI
Electrical characteristics		
Operating voltage	24 VDC ± 10 %	24 VDC ± 10 %
Safety output OSSD, 24 VDC	2 x PNP	2 x PNP
Response time OSSD	10 ... 27 ms	10 ... 37 ms
Switching capacity OSSD	500 mA	500 mA
LED status display, 7-segment display	LED	LED
Mechanical data		
Execution of the electrical connection	Connector	Connector
Connector plug (transmitter/receiver)	4-pole / 8-pole	4-pole / 8-pole
Dimensions ¹⁾	Ø 49 mm	Ø 49 mm
Ambient conditions		
Ambient temperature	-25 °C ... +50 °C	-10 °C ... +50 °C
Degree of protection	IP67	IP67

Safety classification

Standards	EN ISO 13849-1, EN 62061	EN ISO 13849-1, EN 62061
PL/SIL	e/3	e/3
Control category	4	4
PFH	7.42 x 10 ⁻⁹ /h	7.42 x 10 ⁻⁹ /h
Certificates	TÜV, UL, EAC	TÜV, UL, EAC



To get detailed information about the products and certificates, visit products.schmersal.com.



■ SLG420



■ SLG422-P

- Safety light grid
- Standard

- Safety light grid
- Active-passive with deflecting mirror ULS

300, 400 or 500 mm	300 mm
500, 800 or 900 mm	500 mm
2, 3 or 4 beams	2 beams
0.3 ... 50 m	0.3 ... 7 m
■	■
■	■
NSR-0801 (adapter)	NSR-0801 (adapter)
■	■
■	-
-	-
-	-
BC, SI	SI
24 VDC ± 10 %	24 VDC ± 10 %
2 x PNP	2 x PNP
10 ... 15 ms	10 ms
500 mA	500 mA
LED	LED
Connector	Connector
4-pole / 8-pole	8-pole
Ø 49 mm	Ø 49 mm
-25 °C ... +50 °C	-10 °C ... +50 °C
IP67	IP67

EN ISO 13849-1, EN 62061	EN ISO 13849-1, EN 62061
e/3	e/3
4	4
7.42 x 10 ⁻⁹ /h	7.42 x 10 ⁻⁹ /h
TÜV, UL, EAC	TÜV, UL

¹⁾ The height depends on the protection field height.

Key

- BC = Beam coding
- DQ = Double acknowledgement/reset
- MS = Multiple scan
- DM = Setting mode
- SI = Start interlock

16. SAFETY LIGHT GRIDS AND CURTAINS

TYPE 4 – RANGE 420/422 – PREFERRED TYPES

Type to EN 61496	Type	Feature	Series	Special features
Type 4	Safety light curtain SLC	Included in standard version	SLC420	Included in standard version
				High range
		Master / Slave	SLC420 M/S	Master
				Master + High range
	Safety light grids SLG	Included in standard version	SLG420	Slave
				Slave + High range
Active-passive with deflecting mirror ULS	Active-passive with deflecting mirror ULS	SLG422-P	Included in standard version	
			High range	
				Active-passive system

xxx = For different heights and other combinations, see products.schmersal.com.

--- = The material number is dependent on the protective field heights

	Resolution	Protection heights	Range	Type	Material number
	14 mm	170 ... 1450 mm	0.3 ... 7 m	SLC420-ER-xxxx-14-RFB	---
	30 mm	170 ... 1770 mm	0.3 ... 10 m	SLC420-ER-xxxx-30-RFB	---
	50 mm	170 ... 1770 mm	0.3 ... 10 m	SLC420-ER-xxxx-50-RFB	---
	30 mm	170 ... 1770 mm	0.3 ... 18 m	SLC420-ER-xxxx-30-RFBH	---
	14 mm	170 ... 2100 mm	0.3 ... 7 m	SLC420-ER-xxxx-14-RFBM	---
	30 mm	170 ... 2420 mm	0.3 ... 10 m	SLC420-ER-xxxx-30-RFBM	---
	50 mm	170 ... 2420 mm	0.3 ... 10 m	SLC420-ER-xxxx-50-RFBM	---
	30 mm	170 ... 2420 mm	0.3 ... 18 m	SLC420-ER-xxxx-30-RFBMH	---
	14 mm	170 ... 2100 mm	0.3 ... 7 m	SLC420-ER-xxxx-14-RFBS	---
	30 mm	170 ... 2420 mm	0.3 ... 10 m	SLC420-ER-xxxx-30-RFBS	---
	50 mm	170 ... 2420 mm	0.3 ... 10 m	SLC420-ER-xxxx-50-RFBS	---
	30 mm	170 ... 2420 mm	0.3 ... 18 m	SLC420-ER-xxxx-30-RFBSH	---
	2 beams	500 mm	0.3 ... 18 m	SLG420-ER-0500-02-RF	101207359
	3 beams	800 mm	0.3 ... 18 m	SLG420-ER-0800-03-RF	101207360
	4 beams	900 mm	0.3 ... 18 m	SLG420-ER-0900-04-RF	101207361
	2 beams	500 mm	8 ... 50 m	SLG420-ER-0500-02-RFH	101207362
	3 beams	800 mm	8 ... 50 m	SLG420-ER-0800-03-RFH	101207363
	4 beams	900 mm	8 ... 50 m	SLG420-ER-0900-04-RFH	101207364
	2 beams	500 mm	0.3 ... 7 m	SLG422P-ER-0500-02-RF	101207547

16. SAFETY LIGHT GRIDS AND CURTAINS

TYPE 4 – RANGE 440COM/440/445 – OVERVIEW



Key Features

	<ul style="list-style-type: none"> ▪ Safety light curtain ▪ Compact ▪ Integrated Bluetooth LE interface ³⁾ 	<ul style="list-style-type: none"> ▪ Safety light curtain ▪ Standard ▪ Integrated Bluetooth LE interface ³⁾ 	<ul style="list-style-type: none"> ▪ Safety light curtain ▪ Multifunctional
--	--	---	---

Other versions

AS-i SaW (refer to page 258)	–	■ ¹⁾	–
------------------------------	---	-----------------	---

Technical features

Resolution	14, 30, 35 mm	14, 30 mm	14, 30 mm
Protection heights	330 mm ... 1930 mm	170 mm ... 1930 mm	170 mm ... 1770 mm
Number of beams	11 ... 192	8 ... 192	8 ... 144
Range of the protection field	0.3 ... 10 m	0.3 ... 20 m	0.3 ... 10 m
Operating modes			
- Protective mode / Automatic	■	■	■
- Restart interlock (manual reset)	■	■	■
- Parameter setting	Wiring	KA-0974	KA-0976
Functions integrated			
- Contactor control	–	■	■
- Blanking of objects	–	■	■
- Muting	–	–	■
- Cyclic function	–	–	■
- Further functions (see key)	DM	BC, DQ, DM	BC, DQ, MS, DM
Electrical characteristics			
Operating voltage	24 VDC ± 10 %	24 VDC ± 10 %	24 VDC ± 10 %
Safety output OSSD, 24 VDC	2 x PNP (timing)	2 x PNP (timing)	2 x PNP (timing)
Response time OSSD	10 ... 28 ms	10 ... 28 ms	10 ... 27 ms
Switching capacity OSSD	500 mA	500 mA	500 mA
LED status display, 7-segment display	Status display	7-segment display	7-segment display
Mechanical data			
Execution of the electrical connection	Connector	Connector	Connector
Connector plug (transmitter/receiver)	4-pole / 5-pole	4-pole / 8-pole	4-pole / 12-pole
Dimensions ²⁾	27.8 x 33 mm	27.8 x 33 mm	27.8 x 33 mm
Ambient conditions			
Ambient temperature	–10 °C ... +50 °C	–25 °C ... +50 °C	–25 °C ... +50 °C
Degree of protection	IP67	IP67	IP67

Safety classification

Standards	EN ISO 13849-1, EN 62061	EN ISO 13849-1, EN 62061	EN ISO 13849-1, EN 62061
PL/SIL	e/3	e/3	e/3
Control category	4	4	4
PFH	8.05 x 10 ⁻⁹ /h	5.14 x 10 ⁻⁹ /h	5.14 x 10 ⁻⁹ /h
Certificates	TÜV, UL, EAC	TÜV, UL, EAC	TÜV, UL, EAC





■ SLG440COM



■ SLG440



■ SLG445



■ 440/COM IP69

- Safety light grid
- Compact
- Integrated Bluetooth LE interface ³⁾

- Safety light grid
- Standard
- Integrated Bluetooth LE interface ³⁾

- Safety light grid
- Multifunctional

- Safety light curtain SLC/light grid SLG
- Compact
- Integrated Bluetooth LE interface ³⁾

–

■ ¹⁾

–

–

300, 400 or 500 mm	300, 400 or 500 mm	300, 400 or 500 mm	14 ... 500 mm
500, 800 or 900 mm	500, 800 or 900 mm	500, 800 or 900 mm	170 mm ... 1770 mm
2, 3 or 4 beams	2, 3 or 4 beams	2, 3 or 4 beams	8 ... 192
0.3 ... 12 m	0.3 ... 20 m	0.3 ... 20 m	0.3 ... 20 m
■	■	■	■
■	■	■	■
Wiring	KA-0974	KA-0976	Wiring
–	■	■	■
–	■	■	■
–	–	■	–
–	–	■	–
DM	BC, DQ, DM	BC, DQ, MS, DM	BC, DQ, DM
24 VDC ± 10 %	24 VDC ± 10 %	24 VDC ± 10 %	24 VDC ± 10 %
2 x PNP (timing)	2 x PNP (timing)	2 x PNP (timing)	2 x PNP (timing)
10 ms	10 ... 15 ms	10 ... 15 ms	10 ... 28 ms
500 mA	500 mA	500 mA	500 mA
Status display	7-segment display	7-segment display	7-segment display
Connector	Connector	Connector	Connector
4-pole / 5-pole	4-pole / 8-pole	4-pole / 12-pole	4-pole / 8-pole
27.8 x 33 mm	27.8 x 33 mm	27.8 x 33 mm	∅ 50 mm
–10 °C ... +50 °C	–25 °C ... +50 °C	–25 °C ... +50 °C	–10/–25 °C ... +50 °C
IP67	IP67	IP67	IP69

EN ISO 13849-1, EN 62061	EN ISO 13849-1, EN 62061	EN ISO 13849-1, EN 62061	EN ISO 13849-1, EN 62061
e/3	e/3	e/3	e/3
4	4	4	4
8.05 x 10 ⁻⁹ /h	5.14 x 10 ⁻⁹ /h	5.14 x 10 ⁻⁹ /h	5.14 x 10 ⁻⁹ /h
TÜV, UL, EAC	TÜV, UL, EAC	TÜV, UL, EAC	TÜV, UL, EAC

¹⁾ SLC/SLG440-AS versions without BLE available with AS-i SaW interface.

²⁾ The height depends on the protection field height.

³⁾ Bluetooth LE is integrated from version 3.0 onwards.

Key

- BC = Beam coding
- DQ = Double acknowledgement/reset
- MS = Multiple scan
- DM = Setting mode
- SI = Start interlock

To get detailed information about the products and certificates, visit products.schmersal.com.

16. SAFETY LIGHT GRIDS AND CURTAINS

TYPE 4 – RANGE 440COM/440/445 – PREFERRED TYPES

Type to EN 61496	Safety	Feature	Series	Special features
Type 4	Light curtain SLC	Compact	SLC440COM	Compact
				High protection class / Compact + Protective enclosure PH
		Included in standard version	SLC440	Included in standard version
				Integrated status display
				High range and integrated status display
		AS-i	SLC440AS	High protection class / SLC440 + Protective enclosure PH/SH
				Integrated AS-i SaW
	Multifunctional	SLC445	Muting cyclic operation with multiscan	
	Light grids SLG	Compact	SLG440COM	Compact
				High protection class / Compact + Protective enclosure PH
		Included in standard version	SLG440	Included in standard version
				High range
				Integrated status display
		AS-i	SLG440AS	High range and integrated status display
High protection class / SLG440 + Protective enclosure PH/SH				
Multifunctional	SLG445	Integrated AS-i SaW		
Multifunctional	SLG445	Muting cyclic operation with multiscan		

xxxx = For different heights and other combinations, see products.schmersal.com.

--- = The material number is dependent on the protective field heights.

	Resolution	Protection heights	Range	Type	Material number
	14 mm	330 ... 1930 mm	0,3 ... 7 m	SLC440COM-ER-xxxx-14	---
	30 mm	330 ... 1930 mm	0.3 ... 10 m	SLC440COM-ER-xxxx-30	---
	35 mm	330 ... 1930 mm	0,3 ... 7 m	SLC440COM-ER-xxxx-35	---
				SLC440COM-ER-xxxx-xx	---
	14 mm	170 ... 1930 mm	0,3 ... 7 m	SLC440-ER-xxxx-14	---
	30 mm	170 ... 1930 mm	0.3 ... 10 m	SLC440-ER-xxxx-30	---
	14 mm	170 ... 1930 mm	0,3 ... 7 m	SLC440-ER-xxxx-14-01	---
	30 mm	170 ... 1930 mm	0.3 ... 10 m	SLC440-ER-xxxx-30-01	---
	14 mm	170 ... 1930 mm	3 ... 10 m	SLC440-ER-xxxx-14-H1	---
	30 mm	170 ... 1930 mm	4 ... 20 m	SLC440-ER-xxxx-30-H1	---
				SLC440-ER-xxxx-xx-01	---
	14 mm	170 ... 1450 mm	0,3 ... 7 m	SLC440AS-ER-xxxx-14	---
	30 mm	170 ... 1770 mm	0.3 ... 10 m	SLC440AS-ER-xxxx-30	---
	14 mm	170 ... 1450 mm	0,3 ... 7 m	SLC445-ER-xxxx-14-01	---
	30 mm	170 ... 1770 mm	0.3 ... 10 m	SLC445-ER-xxxx-30-01	---
	2 beams	500 mm	0.3 ... 12 m	SLG440COM-ER-0500-02	103004060
	3 beams	800 mm	0.3 ... 12 m	SLG440COM-ER-0800-03	103004063
	4 beams	900 mm	0.3 ... 12 m	SLG440COM-ER-0900-04	103004064
				SLG440COM-ER-xxxx-xx	---
	2 beams	500 mm	0.3 ... 12 m	SLG440-ER-0500-02	101216818
	3 beams	800 mm	0.3 ... 12 m	SLG440-ER-0800-03	101216819
	4 beams	900 mm	0.3 ... 12 m	SLG440-ER-0900-04	101216820
	2 beams	500 mm	4 ... 20 m	SLG440-ER-0500-02-H	103009186
	3 beams	800 mm	4 ... 20 m	SLG440-ER-0800-03-H	103009187
	4 beams	900 mm	4 ... 20 m	SLG440-ER-0900-04-H	103009188
	2 beams	500 mm	0.3 ... 12 m	SLG440-ER-0500-02-01	101216821
	3 beams	800 mm	0.3 ... 12 m	SLG440-ER-0800-03-01	101216822
	4 beams	900 mm	0.3 ... 12 m	SLG440-ER-0900-04-01	101216823
	2 beams	500 mm	4 ... 20 m	SLG440-ER-0500-02-H1	103009189
	3 beams	800 mm	4 ... 20 m	SLG440-ER-0800-03-H1	103009190
	4 beams	900 mm	4 ... 20 m	SLG440-ER-0900-04-H1	103009191
				SLG440-ER-xxxx-xx-01	---
	2 beams	500 mm	0.3 ... 12 m	SLG440AS-ER-0500-02	103007551
	3 beams	800 mm	0.3 ... 12 m	SLG440AS-ER-0800-03	103007554
	4 beams	900 mm	0.3 ... 12 m	SLG440AS-ER-0900-04	103007557
	2 beams	500 mm	0.3 ... 12 m	SLG445-ER-0500-02-01	103005424
	3 beams	800 mm	0.3 ... 12 m	SLG445-ER-0800-03-01	103005425
	4 beams	900 mm	0.3 ... 12 m	SLG445-ER-0900-04-01	103005426
	2 beams	500 mm	3 ... 20 m	SLG445-ER-0500-02-H1	103006524
	3 beams	800 mm	3 ... 20 m	SLG445-ER-0800-03-H1	103006527
	4 beams	900 mm	3 ... 20 m	SLG445-ER-0900-04-H1	103006530

16. SAFETY LIGHT GRIDS AND CURTAINS

SAFETY MONITORING MODULES



■ SRB-E-301MC



■ SRB-E-301ST

Key Features

- Function STOP 0
- 1- or 2-channel control
- Start button / autostart
- 3 safety contacts
- 1 auxiliary contact

- Function STOP 0
- 1- or 2-channel control
- Monitored start button / autostart
- 3 safety contacts
- 1 auxiliary contact

Technical features

Electrical characteristics		
Operating voltage	24 VAC / VDC -20 % / +20 %	24 VAC / VDC -20 % / +20 %
Operating current	0.1 A	0.1 A
Max. switching capacity of the safety contacts	3 x 230 V / 6 A	3 x 230 V / 6 A
of the safe semi-conductor outputs	-	-
of the auxiliary contacts	1 x 24 VDC / 1 A	1 x 24 VDC / 1 A
of the signalling outputs	-	-
Drop-out delay STOP 0	< 10 ms	< 10 ms
STOP 1	-	-
Mechanical data		
With removable terminals	■	■
Dimensions (H x W x D)	22.5 x 98 x 115 mm	22.5 x 98 x 115 mm
Ambient conditions		
Ambient temperature	-25 °C ... +60 °C	-25 °C ... +60 °C

Safety classification

Standards	EN ISO 13849-1, IEC 61508	EN ISO 13849-1, IEC 61508
PL/SIL	e/3	e/3
Control category	4	4
PFH	< 6 x 10 ⁻⁹ /h	< 1.25 x 10 ⁻⁸ /h
Certificates	TÜV, cULus, CCC, EAC	TÜV, cULus, CCC, EAC



To get detailed information about the products and certificates, visit products.schmersal.com.



■ SRB-E-204ST



■ SRB202MSL

- Input expander module
- Monitoring of 4 sensors
- Start button / autostart
- 2 safety outputs
- 4 signalling outputs

- Muting function
- 2 or 4 muting sensors
- Lamp current monitoring
- 2 safety contacts
- 2 signalling outputs

24 VDC -20 % / +20 % 0.125 A	24 VDC -15% / +20% 0.24 A
-	2 x 24 VDC / 4 A
2 x 24 V / 2 A	-
-	-
4 x 24 V / 100 mA < 10 ms	24 VDC / 0.05 A < 20 ms
-	-
■	■
22.5 x 98 x 115 mm	45 x 100 x 121 mm
-25 °C ... +60 °C	-25 °C ... +45 °C

EN ISO 13849-1, IEC 61508 e/3 4 < 2.66 x 10 ⁻⁹ /h TÜV, cULus, CCC, EAC	EN ISO 13849-1, IEC 61508 e/3 4 < 2.0 x 10 ⁻⁸ /h cULus, EAC
---	--

16. SAFETY LIGHT GRIDS AND CURTAINS ACCESSORIES

<p>Protective enclosure SG5/SG6</p>  <ul style="list-style-type: none"> Protective enclosure for SLC/SLG Protection field heights to 970 mm: SG5 to 1930 mm: SG6 <p>103001594 103001596</p>	<p>Protective cover SGS5/SGS6</p>  <ul style="list-style-type: none"> Protective Cover for SG5 and SG6 Protection field heights to 970 mm: SGS5 to 1930 mm: SGS6 <p>103001595 103001597</p>	<p>Tilted mirror for SG5/SG6</p>  <ul style="list-style-type: none"> Tilted mirror for SG5 and SG6 1000 mm: ULS-SG-1000 1870 mm: ULS-SG-1870 <p>103002489 103016046</p>
<p>Mounting post MST</p>  <ul style="list-style-type: none"> Mounting stands Base L/W 135x135 mm Height 500 ... 2000 mm 	<p>Deflecting mirror ULS-M</p>  <ul style="list-style-type: none"> Deflecting mirror series M Mirror height 350 ... 1870 mm Included in delivery: tilted mirror and qty. 2 mounting brackets 	<p>Aligning aid EA5</p>  <ul style="list-style-type: none"> Alignment kit, laser beam 30 m Alignment kit for all SLC/SLG series <p>EA5 101211456</p>
<p>Parametrisation cable KA-0974</p>  <ul style="list-style-type: none"> Parametrisation cable for SLC/SLG 440 Y-splitter, M12, 8-pole with P-button <p>KA-0974 101217615</p>	<p>Parametrisation cable KA-0896</p>  <ul style="list-style-type: none"> Parametrisation cable for SLC/SLG 440COM + SLC/SLG 240COM Y-splitter M12, 5-pole with command device <p>KA-0896 101030161</p>	<p>Parametrisation cable KA-0975</p>  <ul style="list-style-type: none"> Parametrisation cable for SLC/SLG 440-AS Y-splitter M12, 8-pole with command device <p>KA-0896 103005659</p>

Detailed information can be found at products.schmersal.com.







16. SAFETY LIGHT GRIDS AND CURTAINS ACCESSORIES

Connector	Connector	Connector
 <ul style="list-style-type: none"> ■ Connector M12, straight ■ Cable length 4-pole 5 m KA-0804 10 m KA-0805 20 m KA-0808 	 <ul style="list-style-type: none"> ■ Connector M12, straight, 5 pole ■ Cable length 5 m A-K5P-M12-S-G-5M-BK-2-X-A-4-69 10 m A-K5P-M12-S-G-10M-BK-2-X-A-4-69 15 m A-K5P-M12-S-G-15M-BK-2-X-A-4-69 	 <ul style="list-style-type: none"> ■ Connector M12, straight, 12 pole ■ Cable length 5 m KA-0980 101213352 10 m KA-0981 101213353
Protective enclosure SH – stainless steel (440)  <ul style="list-style-type: none"> ■ Protective enclosure IP69 to 490 mm: SH-440-ER-01 103026832 to 890 mm: SH-440-ER-02 103026833 to 1290 mm: SH-440-ER-03 103026834 to 1770 mm: SH-440-ER-04 103026835 	Protective enclosure PH – polyamide (440)  <ul style="list-style-type: none"> ■ Protective enclosure IP69 to 490 mm: PH-440-ER-01 103026836 to 890 mm: PH-440-ER-02 103026837 to 1290 mm: PH-440-ER-03 103026838 to 1770 mm: PH-440-ER-04 103026839 	Protective enclosure PH – polyamide (440COM)  <ul style="list-style-type: none"> ■ Protective enclosure IP69 to 490 mm: PH-COM4-ER-01 103026840 to 890 mm: PH-COM4-ER-02 103026841 to 1290 mm: PH-COM4-ER-03 103026843 to 1770 mm: PH-COM4-ER-04 103026844
Protective enclosure PT with IP67 protection  <ul style="list-style-type: none"> ■ Protective enclosure PT with IP67 protection for SLC440 170 ... 1770 mm: PT-440-ER-xxxx ■ Protective enclosure without IP69 protection for SLC440COM 330 ... 1770 mm: PT-COM4-ER-xxxx 	Test rod PLS-01/-02  <ul style="list-style-type: none"> ■ Test rod 30 mm diameter: PLS-01 101207768 14 mm diameter: PLS-02 101207769 	Vibration damper MSD4  <ul style="list-style-type: none"> ■ Vibration damper ■ Included in delivery: Set with 8 pieces SLC/SLG Type 4: MSD4 101207754

Detailed information can be found at products.schmersal.com.

16. SAFETY LIGHT GRIDS AND CURTAINS

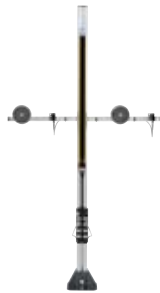
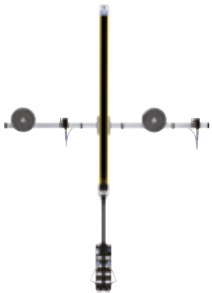
ACCESSORIES – MUTING

<p>MCU-02 103005572</p>  <ul style="list-style-type: none"> ■ Muting connection unit ■ Release/override, transmitter unit (E), up to 4 muting sensors, muting lamp 	<p>S100-PR 103040805</p>  <ul style="list-style-type: none"> ■ Muting sensor M8, 4-pole ■ Reflection light barrier ■ Range 0.1 ... 6.0 m ■ Mounting brackets not included in the delivery 	<p>KA-0976 103005575</p>  <ul style="list-style-type: none"> ■ Programming cable for SLC/SLG445 ■ P-button with connector M12, 12-pole
<p>MUT-SET-L-01 103006073</p>  <ul style="list-style-type: none"> ■ Muting set T-version for mounting to the assembly stand MST ■ Set complete with 2 muting sensors, MCU-02, attachment and cable ■ Set without SLC/SLG445 and MST 	<p>MUT-SET-L-02 103006074</p>  <ul style="list-style-type: none"> ■ Muting set L-version for mounting to the sensor profile ■ Set complete with 2 muting sensors, MCU-02, attachment and cable ■ Set without SLC/SLG445 and MST 	<p>MUT-SET-T-01 103006075</p>  <ul style="list-style-type: none"> ■ Muting set T-version for mounting to the assembly stand MST ■ Set complete with 4 muting sensors, MCU-02, attachment and cable ■ Set without SLC/SLG445 and MST
<p>MUT-SET-T-02 103006076</p>  <ul style="list-style-type: none"> ■ Muting set T-version for mounting to the sensor profile ■ Set complete with 4 muting sensors, MCU-02, attachment and cable ■ Set without SLC/SLG445 and MST 	<p>MUT-SET-T-03 103009195</p>  <ul style="list-style-type: none"> ■ Muting set T-version for mounting to the sensor profile ■ Set complete with 2 muting sensors, MCU-02, attachment and cable ■ Set without SLC/SLG445 and MST 	<p>MUT-SET-T-04 103012263</p>  <ul style="list-style-type: none"> ■ Muting set T-version for mounting to the assembly stand MST ■ Set complete with 2 muting sensors, MCU-02, attachment and cable ■ Set without SLC/SLG445 and MST

Detailed information can be found at products.schmersal.com.

16. SAFETY LIGHT GRIDS AND CURTAINS ACCESSORIES – MOUNTING KITS

MS-1030	101207756	MS-1038	101207757	MS-1051	101207758
 <ul style="list-style-type: none"> ■ Mounting kit for SLC/SLG420 ■ Included in delivery: Angle with screws ■ Set with 4 pieces 		 <ul style="list-style-type: none"> ■ Mounting kit for SLC/SLG420 IP69 and SLC/SLG425I IP69 in V4A ■ Included in delivery: Angle with screws ■ Set with 4 pieces 		 <ul style="list-style-type: none"> ■ Mounting kit lateral fixation for SLC/SLG420 ■ Included in delivery: qty. 2 steel brackets, qty. 4 screws and qty. 4 T-slot nuts 	
 <ul style="list-style-type: none"> ■ Mounting kit for deflecting mirror ULS-A4 ■ Included in delivery: Angle with screws ■ Set with 2 pieces 		 <ul style="list-style-type: none"> ■ Mounting kit for deflecting mirror ULS-M ■ Set with 2 pieces 		 <ul style="list-style-type: none"> ■ Mounting kit for SLC/SLG440COM, SLC/SLG440 and SLC/SLG445 ■ Included in delivery: Angle with screws ■ Set with 4 pieces 	
 <ul style="list-style-type: none"> ■ Mounting kit - Centre fixing for SLC/SLG440COM, SLC/SLG440 and SLC/SLG445 ■ Set with 2 pieces 					

Detailed information can be found at products.schmersal.com.

17. SAFETY-MONITORING MODULES

DESCRIPTION

SAFETY IN SYSTEM

Safety in system: According to this principle the Schmersal Group has been developing and manufacturing safety switchgear for decades, and such a system basically consists of a piece of safety switchgear and the associated safety-oriented signal evaluation.

For the safe signal evaluation the designer has a wide product range available. Next to universal safety relay modules e.g. for the instantaneous separation of the energy supply to potentially dangerous movement (Stop-0-category according to EN 60204-1), special safety components such as double acknowledgment, with differentiated shutdown behaviour and for potentially explosive atmospheres are included. In addition, the program includes safe standstill monitor and safe timing relays.

Also for individual series of safety switchgear, which require a specific type of safe signal evaluation, there are dedicated safety relay modules available, e.g. for the monitoring of optoelectronic protective devices (AODPs) and tactile protection equipment (safety mats and bumpers).

Depending on the external wiring, it is possible to make safe the protective equipment up to Performance Level e according to EN ISO 13849-1.

All the modules that meet the requirements of categories 3 and 4 acc. to EN ISO 13849-1, are set up redundantly. Also, there are many safety relay modules with pluggable screw or spring terminals already available.



The series-connected relay NO contacts of the two positively driven relays implement the safe output contacts. Some modules have an Integrated System Diagnostics (ISD). The LED informs the user about the switching status of the evaluation circuit. In addition, the ISD detects and displays fault conditions. For the user, this means time and cost savings for troubleshooting and rectification.

Short-circuit proof auxiliary transistor outputs or auxiliary relay contacts can be used for messages, control lines and for visualisation purposes.

The program on the following pages presented in compact form, is divided into the product Series PROTECT SRB-E, SRB, AES, and SSW.

17. SAFETY-MONITORING MODULES DESCRIPTION

MULTI-FUNCTIONAL SAFETY RELAY MODULES SRB-E

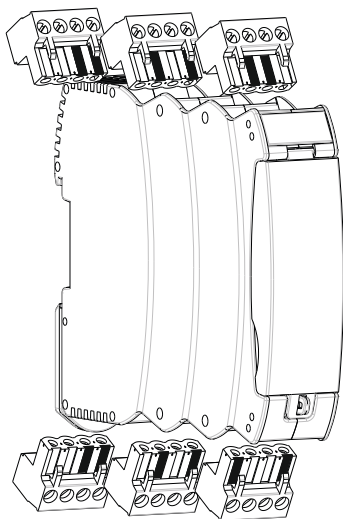

Area of application

The safety relay modules of the new PROTECT SRB-E series are used in safety circuits and are designed for installation in control cabinets. They serve as a means of safely evaluating signals from positive break position switches or safety sensors for safety functions on side sliding, hinged and removable safety guards as well as evaluating EMERGENCY STOP control devices, safety solenoid switches and optoelectronic safety equipment (AOPDs).

All versions of the new family of safety relay modules can be used in applications up to Cat. 4 / PL e in accordance with EN ISO 13849-1 and up to SIL 3 in accordance with EN 62061 / IEC 61508.

A major advantage of the new SRB-E range is that, with each version, several dozen existing SRB modules can be used thanks to the multi-functionality. Each module can be configured for up to eleven different applications via a simple control element. All conventional safety sensors and electromechanical safety equipment can be monitored.

The drastic reduction in the number of variants and the clear display of the relevant functions makes it considerably easier for the machine manufacturer to select the right module for their particular application.

Design and operating principle

Functions such as start / reset monitoring or cross circuit monitoring, for example, can be set via a rotary switch. A second rotary switch is used to set the required drop-out delay time for the safety outputs.

Once the rotary switch has been used to set the configuration required and commissioning is complete, the transparent front panel cover can be secured using a conventional seal.

All PROTECT SRB-E versions are distinguished by very short response times in the requirements profile and signalise detailed diagnostic and status reports via LED displays.

Design Execution

Another bonus feature of the new SRB-E range are the housings which have been optimised by Schmersal according to customer requirements. They are small, compact and feature a range of new, practical functions and properties such as plug-in termination with coding (see illustration on left).



SAFETY-MONITORING MODULES AES

Area of application

The safety modules of the AES series were developed for safe signal processing of non-contact safety-solenoid switches, such as the BNS series developed by Schmersal.

The use of safety-solenoid switches offers, compared to electromechanical safety switches, the advantage that the switchgear can be hidden when mounted (e.g. behind plastic covers). In addition, safety-solenoid switches because of their smooth surfaces are easy to clean. Depending on the design, they achieved very high degrees of protection, and a regular cleaning with steam, or with a high-pressure water jet as used in the food industry is possible, and this does not affect the service life of the safety sensors.

Design and operating principle

The AES-modules monitor the status of the safety-solenoid switches. More precisely they monitor the reed-contact, that serves as the mechanical contacts, which are opened or closed by an external magnetic field.

At the same time the control unit functions also as a current limiter for the reed-contact. This is necessary, because a too high current can lead to the welding of the reed-contacts and therefore to a malfunction of the safety sensors. In addition, the evaluation units take into account the bounce of the reed-contacts and the possible residual vibration of the protection device, which can lead to a premature shutdown of the safety circuit.

Because of these additional functions, more AES module evaluation units are used in connection with safety-solenoid switches, which are designed specifically for these electro-sensitive safety switching devices.

17. SAFETY-MONITORING MODULES

DESCRIPTION

STANDSTILL MONITOR / FAIL-SAFE DELAY TIMER SRB-E / SSW

Area of application

The standstill monitors/fail-safe delay timers are for the reliable detection of the machine standstill or for reliable switch-on delay and activation of the connected solenoid interlocks. Depending on the external wiring in connection with a safety module it is possible to build protective equipment up to category 4, PL e in accordance with EN ISO 13849-1.

Design and operating principle

The standstill monitor and fail-safe delay timer are internally set up redundantly. They contain two safety relays with monitored positively driven contacts or fail-safe semiconductor outputs. The relay series-connected contacts are the output contacts. Only after machine standstill or a switch-on delay time can solenoid interlocks be actuated via the output contacts and the protective equipment be opened.

Series SSW303HV

The sensorless standstill monitor SSW303HV is connected directly to a three-phase AC motor and measures the frequency of the induced voltage.

Once the three-phase motor is at a standstill ($f = 0$) the enabling paths are closed.

















The standstill monitor is equipped with LEDs for displaying the operating conditions.

SRB-E-FWS-TS series

The SRB-E-FWS-TS versions include reliable standstill monitoring and fail-safe delay time functions in a single component. The SRB-E-402FWS-TS module version also offers the option of safety door monitoring contact or output monitoring. In the event of hazardous movements, this module version allows safety door opening to be blocked and, with the second safety function – safety door monitoring – movement to be reliably deactivated. In addition, fail-safe outputs prevent machine startup when a door is open.



OVERVIEW

Series	Area of application	Page	
SRB-E	Emergency stop monitoring		226
	Guard door monitoring		
	Pull-wire emergency stop switch, position switch		
	Safety sensors		
	AOPD monitoring		
	Input expander module		
	Two-hand control panels		
	Safe standstill monitoring		
	Fail-safe delay timer		
	Output expander module		
	Switch mat monitoring		
SRB	Output expander module		
	Muting		
	Double reset		
AES	Magnetic safety sensors BNS		238
SSW303HV	Safe standstill monitoring		242

17. SAFETY-MONITORING MODULES

SRB-E – FUNCTION OVERVIEW AND ORDERING DETAILS

PROTECT SRB-E Included in standard version	Applications								Input signals				Start conditions		
														Start button / autostart	Start button with edge detection
SRB-E-201ST	■	■	■	■	■		■			▲	▲	▲	▲	▲	▲
SRB-E-201LC	■	■	■	■	■					▲	▲	▲	▲	▲	▲
SRB-E-301MC	■	■	■	■	■					▲	▲		▲	■	
SRB-E-301ST	■	■	■	■	■					▲	▲	▲	▲	▲	▲
SRB-E-212ST	■	■	■	■	■					▲	▲	▲	▲	▲	▲
SRB-E-322ST	■	■	■	■	■					▲	▲	▲	▲	▲	▲
SRB-E-232ST	■	■	■	■	■					▲	▲	▲	▲	▲	▲
SRB-E-204ST	■	■	■	■	■	■				▲	▲	▲	▲	▲	▲
SRB-E-204PE	■	■	■	■	■	■				▲	▲	▲	▲	■	
Combination module for 2 protective devices															
SRB-E-402ST	■	■	■	■	■		■			▲	▲	▲	▲	▲	▲
SRB-E-302ST	■	■	■	■	■					▲	▲	▲	▲	▲	▲
Standstill monitoring – Time monitoring – Safety guard monitoring															
SRB-E-302FWS-TS							■			▲	▲	▲	▲		
SRB-E-402FWS-TS	■	■	■	■	■		■			▲	▲	▲	▲	▲	▲
Output expander module															
SRB-E-402EM							■			▲	▲			▲	

Key

- Guard door monitoring
- Magnetic safety sensors BNS
- EMERGENCY STOP monitoring
- Pull-wire emergency stop switch / position switch
- AOPD monitoring
- Two-hand control panels
- Safe standstill monitoring

- Output expander module
- Input expander module for up to 4 sensors
- Input signals: 1-channel
- Input signals: 2-channel
- Input signals: antivalent
- Short-circuit recognition
- Safety output contacts, STOP 0

- Safety output contacts, STOP 1
- Non-safe output contacts: Auxiliary contacts
- Non-safe output contacts: Semi-conductor
- Yes
- ▲ Optional



	Output contacts		Safe STOP 1		not safe		Operating voltage	Type designation	Material number
	Safe STOP 0								
		2				1	24 VDC	SRB-E-201ST	103008067
		2				1	24 VDC	SRB-E-201LC	103009970
	3				1		24 VAC/DC	SRB-E-301MC	103014374
	3				1		24 VAC/DC	SRB-E-301ST	103007672
	2			1		2	24 VDC	SRB-E-212ST	103007222
	3			2	1	1	24 VDC	SRB-E-322ST	103008184
		2	3		1	1	24 VDC	SRB-E-232ST	103014308
		2				4	24 VDC	SRB-E-204ST	103009973
		2				4	24 VDC	SRB-E-204PE	103008070
	2	2			1	1	24 VDC	SRB-E-402ST	103007221
	2	1			2		24 VDC	SRB-E-302ST	103041495
	2	1				2	24 VDC	SRB-E-302FWS-TS	103014754
	2	2			1	1	24 VDC	SRB-E-402FWS-TS	103014757
	4				2		24 VDC / 24 VAC	SRB-E-402EM	103041495

17. SAFETY-MONITORING MODULES

SRB-E – OVERVIEW OF THE SERIES



■ SRB-E-201LC



■ SRB-E-201ST

Key Features

- Function STOP 0
- 1- or 2-channel control
- Start button / autostart
- 2 safety outputs 2 A
- 1 signalling output

- Function STOP 0
- 1- or 2-channel control
- Start button / autostart
- 2 safety outputs 5.5 A
- 1 signalling output

Technical features

Electrical characteristics		
Operating voltage	24 VDC -20 % / +20 %	24 VDC -20 % / +20 %
Operating current	0.1 A	0.1 A
Max. switching capacity of the safety contacts	-	-
of the safe semi-conductor outputs	2 x 24 V / 2 A	2 x 24 V / 5.5 A
of the auxiliary contacts	-	-
of the signalling outputs	1 x 24 V / 100 mA	1 x 24 V / 100 mA
Drop-out delay STOP 0	< 10 ms	< 10 ms
STOP 1	-	-
Mechanical data		
With removable terminals	■	■
Dimensions (H x W x D)	22.5 x 98 x 115 mm	22.5 x 98 x 115 mm
Ambient conditions		
Ambient temperature	-25 °C ... +60 °C	-25 °C ... +60 °C

Safety classification

Standards	EN ISO 13849-1, IEC 61508	EN ISO 13849-1, IEC 61508
PL/SIL	e/3	e/3
Control category	4	4
PFH	< 2.66 x 10 ⁻⁹ /h	< 2.66 x 10 ⁻⁹ /h
Certificates	TÜV, cULus, CCC, EAC	TÜV, cULus, CCC, EAC



To get detailed information about the products and certificates, visit products.schmersal.com.



■ SRB-E-301MC



■ SRB-E-301ST



■ SRB-E-302ST



■ SRB-E-212ST

- Function STOP 0
- 1- or 2-channel control
- Start button / autostart
- 3 safety contacts
- 1 auxiliary contact

- Function STOP 0
- 1- or 2-channel control
- Monitored start button / autostart
- 3 safety contacts
- 1 auxiliary contact

- Function STOP 0
- Monitoring of 2 sensors
- 1- or 2-channel control
- 2 safety contacts, STOP 0
- 1 safety output STOP 0

- Function STOP 0/1
- 1- or 2-channel control
- 2 safety contacts, STOP 0
- 1 safety output STOP 1
- Drop-out delay 0 ... 30 s

24 VAC / VDC -20 % / +20 %	24 VAC / VDC -20 % / +20 %	24 VDC -20 % / +20 %	24 VDC -20 % / +20 %
0.1 A	0.1 A	0.125 A	0.125 A
3 x 230 V / 6 A	3 x 230 V / 6 A	2 x 230 V / 6 A	2 x 230 V / 6 A
-	-	1 x 24 V / 2 A	1 x 24 V / 2 A
1 x 24 V / 1 A	1 x 24 V / 1 A	-	-
-	-	2 x 24 V / 100 mA	2 x 24 V / 100 mA
< 10 ms	< 10 ms	< 10 ms	< 10 ms
-	-	-	0 ... 30 s
■	■	■	■
22.5 x 98 x 115 mm	22.5 x 98 x 115 mm	22.5 x 98 x 115 mm	22.5 x 98 x 115 mm
-25 °C ... +60 °C	-25 °C ... +60 °C	-25 °C ... +60 °C	-25 °C ... +60 °C

EN ISO 13849-1, IEC 61508	EN ISO 13849-1, IEC 61508	EN ISO 13849-1, IEC 61508	EN ISO 13849-1, IEC 61508
e/3	e/3	e/3	e/3
4	4	4	4
< 6.0 x 10 ⁻⁹ /h	< 1.25 x 10 ⁻⁸ /h	< 1.25 x 10 ⁻⁸ /h / < 2.66 x 10 ⁻⁹ /h	< 1.25 x 10 ⁻⁸ /h / < 2.66 x 10 ⁻⁹ /h
TÜV, cULus, CCC, EAC	TÜV, cULus, CCC, EAC	TÜV, cULus, CCC, EAC	TÜV, cULus, CCC, EAC

17. SAFETY-MONITORING MODULES

SRB-E – OVERVIEW OF THE SERIES



■ SRB-E-322ST



■ SRB-E-232ST

Key Features

- Function STOP 0/1
- 1- or 2-channel control
- 3 safety contacts, STOP 0
- 2 safety outputs STOP 1
- Drop-out delay 0 ... 30 s

- Function STOP 0/1
- 1- or 2-channel control
- 2 safety outputs STOP 0
- 3 safety contacts, STOP 1
- Drop-out delay 0 ... 30 s

Technical features

Electrical characteristics		
Operating voltage	24 VDC -20 % / +20 %	24 VDC -20 % / +20 %
Operating current	0.1 A	0.1 A
Max. switching capacity of the safety contacts	3 x 230 V / 5.5 A	3 x 230 V / 5.5 A
of the safe semi-conductor outputs	2 x 24 V / 2 A	2 x 24 V / 2 A
of the auxiliary contacts	1 x 24 V / 1 A	1 x 24 V / 1 A
of the signalling outputs	1 x 24 V / 100 mA	1 x 24 V / 100 mA
Drop-out delay STOP 0	< 10 ms	< 10 ms
STOP 1	0 ... 30 s	0 ... 30 s
Mechanical data		
With removable terminals	■	■
Dimensions (H x W x D)	22.5 x 98 x 115 mm	22.5 x 98 x 115 mm
Ambient conditions		
Ambient temperature	-25 °C ... +60 °C	-25 °C ... +60 °C

Safety classification

Standards	EN ISO 13849-1, IEC 61508	EN ISO 13849-1, IEC 61508
PL/SIL	e/3	e/3
Control category	4	4
PFH	< 1.25 x 10 ⁻⁸ /h / < 2.66 x 10 ⁻⁹ /h	< 1.25 x 10 ⁻⁸ /h / < 2.66 x 10 ⁻⁹ /h
Certificates	TÜV, cULus, CCC, EAC	TÜV, cULus, CCC, EAC



To get detailed information about the products and certificates, visit products.schmersal.com.



■ SRB-E-204ST



■ SRB-E-204PE



■ SRB-E-402ST



■ SRB-E-402EM

- Function STOP 0
- Monitoring of 4 sensors
- Start button / autostart
- 2 safety outputs
- 4 signalling outputs

- Input expander module
- 1- or 2-channel control
- Monitoring of 4 sensors
- 2 safety outputs
- 4 signalling outputs

- 2x function STOP 0
- 2x 1- or 2-channel control
- 2x start button / autostart
- 2 safety contacts
- 2 safety outputs

- Contact expansion
- 4 safety contacts
- 2 signalling contacts
- Feedback contacts

24 VDC -20 % / +20 % 0.125 A	24 VDC -20 % / +20 % 0.125 A	24 VDC -20 % / +20 % 0.15 A	24 VAC / VDC -15 % / +20 %
-	-	2 x 230 V / 6 A	4 x 230 V / 6 A
2 x 24 V / 2 A	2 x 24 V / 2 A	2 x 24 V / 2 A	-
-	-	1 x 24 V / 1 A	2 x 24 V / 2 A
4 x 24 V / 100 mA	4 x 24 V / 100 mA	1 x 24 V / 100 mA	-
< 10 ms	< 10 ms	< 10 ms	< 35 ms
-	-	-	-
■	■	■	■
22.5 x 98 x 115 mm	22.5 x 98 x 115 mm	22.5 x 98 x 115 mm	22.5 x 98 x 115 mm
-25 °C ... +60 °C	-25 °C ... +60 °C	-25 °C ... +60 °C	-25 °C ... +60 °C

EN ISO 13849-1, IEC 61508 e/3 4	EN ISO 13849-1, IEC 61508 e/3 4	EN ISO 13849-1, IEC 61508 e/3 4	EN ISO 13849-1, IEC 61508 e/3 4
< 2.66 x 10 ⁻⁹ /h	< 2.66 x 10 ⁻⁹ /h	< 1.25 x 10 ⁻⁸ /h / < 2.66 x 10 ⁻⁹ /h	< 2.0 x 10 ⁻⁸ /h
TÜV, cULus, CCC, EAC	TÜV, cULus, CCC, EAC	TÜV, cULus, CCC, EAC	cULus, CCC, EAC

17. SAFETY-MONITORING MODULES

SRB-E – OVERVIEW OF THE SERIES



■ SRB-E-302FWS-TS

■ SRB-E-402FWS-TS

Key Features

- Standstill monitoring using 1 or 2 impulse sensors
- Additional standstill signal
- 2-channel time monitoring
- 2 safety contacts
- 1 safety output
- 2 signalling outputs

- Standstill monitoring using 1 or 2 impulse sensors
- Additional standstill signal
- 2-channel time monitoring
- 2-channel safety door monitoring
- 2 safety contacts
- 2 safety outputs
- 2 signalling outputs

Technical features

Electrical characteristics		
Operating voltage	24 VDC -20 % / +20 %	24 VDC -20 % / +20 %
Operating current	0.125 A	0.15 A
Max. switching capacity of the safety contacts	2 x 230 V / 6 A	2 x 230 V / 6 A
of the safe semi-conductor outputs	1 x 24 V / 2 A	2 x 24 V / 2 A
of the auxiliary contacts	-	1 x 24 V / 1 A
of the signalling outputs	2 x 24 V / 100 mA	1 x 24 V / 100 mA
Drop-out delay STOP 0	< 10 ms	< 10 ms
STOP 1	-	-
Mechanical data		
With removable terminals	■	■
Dimensions (H x W x D)	22.5 x 98 x 115 mm	22.5 x 98 x 115 mm
Ambient conditions		
Ambient temperature	-25 °C ... +60 °C	-25 °C ... +60 °C

Safety classification

Standards	EN ISO 13849-1, IEC 61508	EN ISO 13849-1, IEC 61508
PL/SIL	e/3	e/3
Control category	4	4
PFH	< 1.25 x 10 ⁻⁸ /h / < 2.66 x 10 ⁻⁹ /h	< 1.25 x 10 ⁻⁸ /h / < 2.66 x 10 ⁻⁹ /h
Certificates	TÜV, cULus, CCC, EAC	TÜV, cULus, CCC, EAC



To get detailed information about the products and certificates, visit products.schmersal.com.

UP-TO-DATE WITHOUT FAIL THE SCHMERSAL WEBSHOP

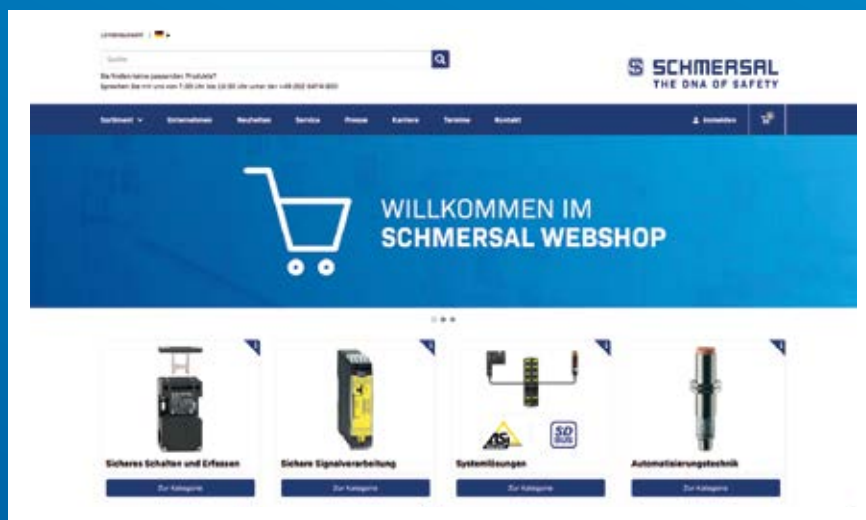

FOR DETAILED INFORMATION, CHECK OUT
[PRODUCTS.SCHMERSAL.COM](https://products.schmersal.com)

17. SAFETY-MONITORING MODULES

SRB – FUNCTION OVERVIEW AND ORDERING DETAILS

Series Included in standard version	Applications												Output contacts			
													safe	not safe		
SRB301ST 230V	■	■	■										3	0	1	0
Series for special applications																
SRB100DR												■	0	1	0	0
SRB202MSL											■		2	0	0	3
Input and output expander module																
SRB402EM											■		4	0	2	0

Key

- Guard door monitoring
- Magnetic safety sensors BNS
- EMERGENCY STOP monitoring
- Safety output contacts, STOP 0
- Not safe output contacts: Auxiliary contacts
- Not safe output contacts: Semi-conductor
- Input signals: 1-channel
- Input signals: 2-channel
- Input signals: 3-channel
- Short-circuit recognition
- Yes
- Optional



Input signals				Start conditions		Operating voltage	Type	Material number
				Start button / autostart	Start button with edge detection			
■	■		▲	■	■	48 ... 240 VAC	SRB301ST-230V	101170099
	■				■	24 VDC / 24 VAC	SRB100DR	101186279
	■		▲	■		24 VDC	SRB202MSL-24V	101181998
■	■			■		24 VDC / 24 VAC	SRB402EM-24V	101170840

17. SAFETY-MONITORING MODULES

SRB – OVERVIEW OF THE SERIES



■ SRB301ST-230V



■ SRB100DR

Key Features

- Function STOP 0
- 1- or 2-channel control
- Start button / autostart
- Start with edge detection
- 1 auxiliary contact

- Double acknowledgement/reset
- 2x start with edge detection
- Time monitoring 3 ... 30 s
- Adjustable time window
- 1 safety contact (impulse)

Technical features

Electrical characteristics		
Operating voltage	48 ... 240 VAC	24 VDC -15 % / +20 % 24 VAC -15 % / +10 %
Operating current	0.12 A	0.14 A
Electronic fuse	■	■
Hybrid fuse	-	-
Pull-in delay (typ.)	30 ms	-
Automatic start with reset-button / start button	15 ms	Dependent on time monitoring
Max. switching capacity of the safety contacts	250 VAC / 6 A	250 VAC / 8 A
of the auxiliary contacts	24 VDC / 2 A	-
of the signalling outputs	-	-
Switching capacity AC15, DC13		
STOP 0	230 VAC / 6 A, 24 VDC / 6 A	230 VAC / 3 A, 24 VDC / 2 A
STOP 1	-	-
Drop-out delay (typ.) in case of emergency stop	20 ms	-
Mechanical data		
With removable terminals	■	■
Dimensions (H x W x D)	22.5 x 121 x 120 mm	22.5 x 121 x 100 mm
Ambient conditions		
Ambient temperature	-25 °C ... +45 °C	-25 °C ... +60 °C

Safety classification

Standards	EN ISO 13849-1, IEC 61508	EN ISO 13849-1, IEC 61508
PL/SIL	e	e/3
Control category	4	4
PFH	$\leq 2.0 \times 10^{-8}/h$	$\leq 2.0 \times 10^{-8}/h$
Certificates	TÜV, cULus, EAC	cULus, EAC



To get detailed information about the products and certificates, visit products.schmersal.com.



■ SRB202MSL



■ SRB402EM

- Muting function
- 2 or 4 muting sensors
- Lamp current monitoring
- 2 safety contacts
- 2 signalling outputs











- Contact multiplication
- 4 safety contacts
- 2 auxiliary contacts
- Feedback contacts

24 VDC -15 % / +20 %	24 VDC -15 % / +20 % 24 VAC -15 % / +10 %
0.24 A	0.05 A
■	-
-	-
200 ms	30 ms
-	-
24 VDC / 4 A	250 VAC / 6 A
-	24 VDC / 2 A
24 VDC / 0.05 A	-
24 VDC / 1.2 A	230 VAC / 6 A, 24 VDC / 6 A
20 ms	25 ms
■	■
45 x 121 x 100 mm	22.5 x 121 x 120 mm
-25 °C ... +45 °C	-25 °C ... +45 °C





EN ISO 13849-1, IEC 61508	EN ISO 13849-1, IEC 61508
e/3	e/3
4	4
$\leq 2.0 \times 10^{-8}/h$	$\leq 2.0 \times 10^{-8}/h$
cULus, EAC	cULus, EAC





17. SAFETY-MONITORING MODULES



AES – FUNCTION OVERVIEW AND ORDERING DETAILS

Range	Applications			Number of sensors that can be connected				Output contacts			Input signals				
				1	2	3	4 - 6								
AES 1112			■		■			1					■	■	
AES 1102			■	■				1					■	■	

Key

-  Guard door monitoring
-  Magnetic safety sensors BNS
-  EMERGENCY STOP monitoring
-  Safety output contacts, STOP 0

-  Not safe output contacts: Auxiliary contacts
-  Not safe output contacts: Semi-conductor
-  Input signals: 1-channel
-  Input signals: 2-channel

-  Input signals: 3-channel
-  Short-circuit recognition
- Yes
- ▲ Optional



	Start conditions			Operating voltage	Type designation	Material number
	Start button / autostart	Start button with edge detection	Start-up test			
■				24 VDC	AES 1112	101128982
				110 VAC	AES 1112.1	101128798
				230 VAC	AES 1112.2	101128799
				24 VAC	AES 1112.3	101128800
				42 VAC	AES 1112.4	101126153
■				24 VDC	AES 1102	101128981
				110 VAC	AES 1102.1	101128795
				230 VAC	AES 1102.2	101128796
				42 VAC	AES 1102.4	101126152

17. SAFETY-MONITORING MODULES

AES – OVERVIEW OF THE SERIES



■ AES 1102



■ AES 1112

Key Features

- 3-channel control, antivalent
- 2 Sensors
- Autostart
- 1 safety contact

- 3-channel control, antivalent
- Autostart
- 1 safety contact

Technical features

Electrical characteristics		
Operating voltage	24 VDC ±15 %	24 VDC ±15 %
Operating current	0.1 A	0.1 A
Electronic fuse	–	–
Hybrid fuse	–	–
Pull-in delay (typ.)	100 ms	100 ms
Automatic start with reset-button / start button	–	–
Max. switching capacity of the safety contacts	250 VAC / 4 A	250 VAC / 4 A
of the auxiliary contacts	–	–
of the signalling outputs	–	–
Switching capacity AC15, DC13	230 VAC / 1.5 A, 24 VDC / 1 A	230 VAC / 3 A, 24 VDC / 2 A
Drop-out delay (typ.) in case of emergency stop	50 ms	50 ms
Mechanical data		
With removable terminals	–	–
Dimensions (H x W x D)	22.5 x 110 x 75 mm	22.5 x 110 x 75 mm
Ambient conditions		
Ambient temperature	0 °C ... +55 °C	0 °C ... +55 °C

Safety classification

Standards	EN ISO 13849-1, IEC 61508	EN ISO 13849-1, IEC 61508
PL/SIL	c/1	c/1
Control category	1	1
PFH	$1.2 \times 10^{-6}/h$	$1.2 \times 10^{-6}/h$
Certificates	BG, cULus	BG, cULus



To get detailed information about the products and certificates, visit products.schmersal.com.





**UP-TO-DATE WITHOUT FAIL
ONLINE ON THE WORLD WIDE WEB**







**FOR DETAILED INFORMATION, CHECK OUT
WWW.SCHMERSAL.COM**

17. SAFETY-MONITORING MODULES

SSW – FUNCTION OVERVIEW AND ORDERING DETAILS

Range Standstill monitors	Application 	Standstill frequency			Sensorless standstill detection	Integral system diagnostics	Output contacts			
		Channel 1, 1 Hz Channel 2, 1 Hz	Channel 1, 2 Hz Channel 2, 2 Hz	Channel 1, 1 Hz Channel 2, 2 Hz			safe 		not safe 	
SSW303HV	■				■		3	0	3	0

Key

-  Safe standstill monitoring
-  Safety output contacts, STOP 0
-  Safety output contacts, STOP 1
-  Not safe output contacts:
Auxiliary contacts
-  Not safe output contacts:
Semi-conductor
- Yes
- ▲ Optional



Input signals (detect standstill)				Start conditions		Operating voltage	Type	Material number
1 impulse generator	2 impulse generators	AC motors	Standstill detection time	Autostart	Feedback circuit			
		■	7s	■	■	24 ... 230 VAC	SSW303HV	103034847
			2s			24 ... 230 VAC	SSW303HV-2S	103037586

17. SAFETY-MONITORING MODULES

SSW – OVERVIEW OF THE SERIES



■ SSW303HV

Key Features

- Sensorless monitoring (EMK)
- Motor voltage range 0 ... 690 VAC
- Feedback circuit
- 3 safety contacts
- 3 signalling contacts

Technical features

Electrical characteristics

Operating voltage	24 VDC, 24 ... 230 VAC
Operating current	0.17 A
Electronic fuse	–
Sensors	Sensorless monitoring (EMK)
Max. motor voltage	690 VAC
Max. input frequency	–
Min. impulse duration	–
Input signal "1"	–
Input signal "0"	–
Max. switching capacity of the safety contacts	250 VAC / 6 A
of the auxiliary contacts	24 VDC / 2 A
of the signalling outputs	–
Switching capacity AC15, DC13	230 VAC / 6 A, 24 VDC / 6 A
Mechanical data	
With removable terminals	■
Dimensions (H x W x D)	45 x 121 x 120 mm
Ambient conditions	
Ambient temperature	–25 °C ... +55 °C

Safety classification

Standards	EN ISO 13849-1, IEC 61508
PL/SIL	e/3
Control category	4
PFH	≤ 2.0 x 10 ⁻⁸ /h
Certificates	BG, cULus, EAC



To get detailed information about the products and certificates, visit products.schmersal.com.

tec.nicum

YOUR PARTNER FOR MACHINE SAFETY AND WORKPLACE PROTECTION

tec.nicum is the service division of the Schmersal Group. It offers machine manufacturers, machine operators and distributors competent advice with product and manufacturer neutrality.

tec.nicum supports its clients in the reliable design of machines and workplaces. The tec.nicum team drafts and realises safety solutions across all lifecycle stages of the machine.

The range of services:



tec.nicum academy
Seminars and training



tec.nicum consulting
Consultancy Services



tec.nicum engineering
Design, planning and
PLC programming



tec.nicum integration
Execution and installation



**FOR DETAILED INFORMATION, CHECK OUT
WWW.TECNICUM.COM**

18. MULTIFUNCTIONAL SAFETY CONTROLLER DESCRIPTION

MULTIFUNCTIONAL SAFETY MODULE WITH PROGRAM SELECTION FUNCTION

With the multifunctional PROTECT SELECT compact safety module, the engineer has greater flexibility during configuration of the safety device and its subsequent integration into the machine functions.

Four different programs are available. Each program can be precisely adapted – without any programming knowledge, simply with the menu and clear text messages – to the specific application case. This allows for example the release delay and the debounce time to be set individually, and numerous parameters such as the cross-wire monitoring to be set as required – a definite advantage in comparison to safety relay modules.

With every application program the user profits from numerous functions – such as:

- Connection of up to six dual-channel safety switching devices (with or without potential) up to PL e / SIL 3
- Safety semi-conductor and relay outputs with Stop 0 or Stop 1 (adjustable)
- Safe analogue monitoring of temperature and other process variables
- Free assignment of feedback circuit (EDM), start-up tests, periodic tests, discrepancy monitoring, auto start and manual start
- Cross-circuit detection via clock outputs
- Display of clear text messages during troubleshooting
- Input filter for safety devices with contact bounce



OVERVIEW

Application program no.	1	2	3	4
Safety areas	1	2	1	1
Inputs				
Sensors with adjustable parameters	5	1+(2 / 3)*	6	2
Operating mode switch/enabling switch	■			
Muting function				■
Prioritised emergency stop		■	■	
RESET	1	3	2	1
Feedback circuit	1	2	1	1
Relay and semi-conductor outputs				
STOP 0	■	■	■	■
STOP 1 with fail-safe timer	■	■	■	■

* This means that two safety areas are monitored: Area A with two sensors and area B with three sensors. A prioritised emergency stop is installed.

TYPE DESIGNATION

Range	Connection type	Type	Material number
PROTECT SELECT	Cage clamps	PROTECT SELECT-CC	101215377

18. MULTIFUNCTIONAL SAFETY CONTROLLER

DESCRIPTION

APPLICATION PROGRAM 1

One safety area with operating mode switch / enabling switch

Program 1 allows you to connect up to four dual-channel safety switching devices, each of which can be bridged by means of operating mode switches and enabling switches. The program is ideally suited for hazardous areas where additional operating modes such as “setting-up mode” and “process monitoring” are facilitating tasks like setting up a machine or troubleshooting.

- Up to four safety switching devices can be bridged in conformance with standards
- Additional emergency stop function
- Direct control of a solenoid interlock (lock / unlock)

APPLICATION PROGRAM 2

Two safety areas

It is often useful to provide two separate safety areas for the particular workplaces on machines. Program 2 has been developed for this application. Here is an example from the packaging machine industry: The upper part of the machine is the work area, where packaging units are fed and packaged.

The lower part of the machine houses the material feed mechanism and the drive units. It must only be accessed for maintenance purposes, but must still be monitored with a safety switching device. This functionality can be achieved with application program 2 of PROTECT SELECT.

- For up to three safety switching devices per safety area
- Start / reset function for each safety area
- Feedback circuits (EDM) for each safety area
- Prioritised emergency stop with independent reset function



APPLICATION PROGRAM 3

One safety area with up to six safety switching devices

Program 3 can be used for processing signals of up to six safety switching devices. The application program allows you to assign a separate reset function to one of the safety switching devices. This way, even the most complex safety areas which are monitored by several safety switching devices can be conveniently configured.

- For up to six safety switching devices
- Direct control of a solenoid interlock (lock / unlock)
- Prioritised emergency stop with independent reset function

APPLICATION PROGRAM 4

One safety area with safe bridging (muting)

In order to ensure a material transport into and out of a safety area without provoking a machine stop, an optoelectronic safety device which is bridged automatically and for a limited amount of time should be used.

Usually a safety light-grid with integrated muting function is required for this purpose. When PROTECT SELECT is used, the muting function can be monitored directly via standard safety light-grids and sensors. In addition, signals from two other safety switching devices can be processed. This enables the user to realise a complete muting application with e.g. an additional guard door and an emergency stop function.

- Muting function with standard optoelectronic safety devices
- Flexible muting time parameterisation
- Connection of additional emergency stop function and safety switching device
- Direct control of a solenoid interlock (lock / unlock)

18. MULTIFUNCTIONAL SAFETY CONTROLLER

OVERVIEW OF THE SERIES



■ PROTECT SELECT

Technical features

General data		
Start conditions	automatic or start button (optionally monitored)	
Start input available	■	
Feedback circuit available	■	
Start-up test available	■	
Automatic reset function	■	
Reset with edge detection	■	
Response time	Switch on ¹⁾	Shut-down
safe digital output via digital / analogue input	< 45 ms / < 120 ms	< 30 ms / < 100 ms
safe relay output via digital / analogue input	< 65 ms / < 140 ms	< 50 ms / < 120 ms
Electrical characteristics		
Number of safety digital inputs	up to 18 x, application dependent	
Number of safety analogue inputs	2 x	
Number of safety digital outputs	2 x p-type, 1 x p/n-type, OEM: 2 x p/n-type	
Number of safety relay outputs	2 x with common centre-tap	
Number of signalling outputs	up to 4 x, application dependent	
Number of pulse outputs	3x	
Cross / short circuit detection possible	■	
Supply voltage	24 VDC - / +10% (stabilised PELV)	
Operating current	max. 500 mA, plus load current	
Device fuse rating	3 A slow blow	
Mechanical data		
Connection type	Cage clamps	
Dimensions (H x W x D)	52.5 x 118 x 100 mm	
Ambient temperature	-25 °C ... +55 °C	

¹⁾ To the indicated switch-on times, the set stabilising time must be added.



To get detailed information about the products and certificates, visit products.schmersal.com.

18. MULTIFUNCTIONAL SAFETY CONTROLLER OVERVIEW OF THE SERIES



Safety classification

Standards	EN ISO 13849-1, EN 62061, EN 60947-5-1, IEC 61508
PL	up to e
Control category	up to 4
DC	medium
CCF	> 65 points
PFH-value	$\leq 1.78 \times 10^{-8}/h$ (Valid for dual channel and 60% relay load)
SIL	up to 3
SFF	> 90 %
Usage duration	20 years
Hardware fault tolerance	1
Demand rate	high or continuous
Certificates	TÜV, cULus, CCC

19. PROGRAMMABLE MODULAR SAFETY CONTROLLER DESCRIPTION

PROTECT PSC1

The safety control system PSC1 consists of freely programmable compact safety controllers and I/O extension modules for reliable signal processing of EMERGENCY STOP switches, guard door switches, light grids and additional mechanical and electronic safety switchgear. Additionally there is the possibility via numerous functions to monitor axes. Using the universal communications interface a connection can be established to all the standard field bus systems.

- Safe logic control according to Annex IV of the Machinery Directive 2006/42/EC
- Connection for all standard safety relays up to PL e and SIL 3
- Modular expansion with up to 272 inputs / outputs
- Four secure 2 A p-switching semiconductor outputs, can be switched to secure pn-switching semiconductor outputs
- Freely programmable inputs / outputs, 2 A p-switching
- Safe drive monitoring according to EN 61800-5-2 (SDM – Safe Drive Monitoring)
- Up to 12 axes
- Universal communication interface:
 - Supports all standard fieldbus systems
 - Setting and resetting of fieldbus protocols by software
 - Safe remote I/Os via Ethernet Safety Device to Device Communication (SDDC)
 - Safe cross communication via Ethernet Safety Master to Master Communication (SMMC)
 - Integrated Schmersal SD Bus connection to the standard field bus systems
- Safety functionalities up to SIL 3 according to IEC 61508 / EN 62061, PL e and Cat. 4 according to EN ISO 13849-1

SAFEPLC2

- Modern, object-oriented environment
- Preconfigured elements for safe electronic and electromechanical switching devices
- Easy reuse of application code by macros
- Programming assistance by various search functions
- Simple signal tracking by different colour representation and status messages
- Safety functions are easy to configure thanks to practical libraries for logic elements, input elements, output elements, Safe Drive monitoring elements, SD bus and encoder elements
- Configurable user permissions

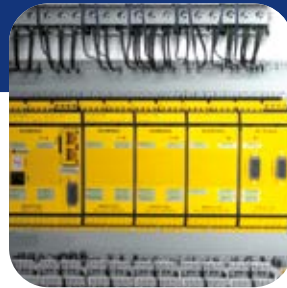

COMPACT CONTROLLER PSC1-C-10

The PSC1-C-10 is a modular and freely programmable compact controller for safe signal processing of safety switchgear with the options of an integrated drive monitoring and/or a universal communications interface. The base version of the PSC1-C-10 controller has the following properties:

- 14 safe inputs up to PL e respectively SIL 3
- 4 / 2 fail-safe semiconductor outputs, with adjustable parameters:
 - 2 A p-switching or pn-switching
- 2 safe relay outputs for 24 VDC or 230 VAC, 2 A
- 2 signalling outputs, 250 mA
- 2 pulse outputs (clock outputs) for contact sensors
- Cycle time: 8 ms
- SDHC card slot for storing application programs (optional)
- Modular expandable with up to 2 I/O expansion modules (central / decentral)
- Up to 64 inputs/outputs possible
- SDHC card slot for storing application programs (optional)
- Safe drive monitoring for up to 2 axes (optional)
- Universal communication interface (optional)

COMPACT CONTROLLER PSC1-C-100

The PSC1-C-100 is a modular and freely programmable compact controller for safe signal processing of safety switchgear with the option of a universal communications interface. The base version of the PSC1-C-100 controller has the following properties:

- 14 safe inputs up to PL e respectively SIL 3
- 10 adjustable safe in-/outputs up to PL e respectively SIL 3, 2 A p-switching
- 10 adjustable safe in-/outputs up to PL e respectively SIL 3, 0.5 A p-switching
- 4 / 2 fail-safe semiconductor outputs, with adjustable parameters:
 - 2 A p-switching or pn-switching
- 2 safe relay outputs for 24 VDC or 230 VAC, 2 A
- 2 signalling outputs, 250 mA
- 2 pulse outputs (clock outputs) for contact sensors
- Cycle time: min. 16 ms
- SDHC card slot for storing application programs (optional)
- Modular expandable up to 8 I/O modules (central / decentral)
- Up to 272 inputs/outputs possible
- Modular expandable with up to 6 safe drive monitoring modules (max. 12 axes)
- Universal communication interface (optional)

19. PROGRAMMABLE MODULAR SAFETY CONTROLLER DESCRIPTION

SAFE I/O EXPANSION MODULES

The I/O expansion modules can be freely used for the compact controllers and differ in their application:

1. Central applications
in the same control cabinet directly stackable to the compact controller and communication takes place via the backwall bus
2. Decentral applications
spatially separate control cabinet,
communication to the compact controller is via Ethernet SDDC

Modular compact controller PSC1-C-10 – 2 expansion modules / up to 64 I/Os

The compact controller PSC1-C-10 can be expanded with up to 2 I/O expansion modules.

Modular compact controller PSC1-C-100 – 8 expansion modules / up to 272 I/Os

The compact controller PSC1-C-100 can be expanded with up to 8 I/O expansion modules.

A mixture of centralised and decentralised applications is possible with the PSC1-C-100.

SAFE REMOTE I/O COMMUNICATION

Ethernet SDDC (Safety Device to Device Communication)

For the decentral application structure the I/O remote expansion module PSC1-E-37-14DI-4DO-2RO-RIO is available.

The local communication is realised via the Ethernet SDDC protocol.

The universal communication interface allows for operation with simultaneous safe cross-communication and remote I/O communication.

SAFE CROSS-COMMUNICATION

Ethernet SMMC (Safety Master to Master Communication)

The safe cross-communication is used as a composite of safety controllers to safely exchange data via the local Ethernet SMMC communication.

In a complete system (consisting of individual system components) with concatenated EMERGENCY STOP signals or concatenated signals from solenoid interlocks, this requirement can be solved by using the safe cross-communication.

The simultaneous operation of safe cross-communication and safe remote I/O communication and a field-bus communication for a superordinate control is possible.

- Safe cross-communication with up to 4 compact controllers PSC1
- Free mixing of compact controllers PSC1-C-10 and PSC1-C-100



UNIVERSAL COMMUNICATION INTERFACE

Universal field-bus connection

Using the universal communication interface the required field-bus protocol can be manually selected via software.

Parallel to the active field-bus protocol, the local communication within the PSC1 control system can be realised via the Ethernet SDDC and SMMC.

The safe fieldbus protocols ProfiSafe and FSoE are also supported. The PSC1 can thus be easily integrated into existing safe networks

Integrated SD Bus gateway

Up to 31 Schmersal SD bus sensors can be connected and evaluated with their extended diagnostic data directly onto the compact controller PSC1.

In doing so, the universal communication interface takes on the task of a gateway to the respective field-bus protocols, set via software (communication to machine controller).

SAFE DRIVE MONITORING (SDM)

Safe drive monitoring for up to 12 axes

For safe drive monitoring many safety features are supported:

- Safe shutdown: Safe Torque OFF (STO)
- Safe stopping: Safe Stop 1 (SS1), Safe Stop 2 (SS2), Safe Operating Stop (SOS)
- Safe movement: Safely-Limited Speed (SLS), Safe Direction (SDI)
- Safe monitoring: Safe Cam (SCA)
- Safe positioning: Safely-Limited Position (SLP), Safely-Limited Increment (SLI), Safely Emergency Limit (SEL)

The drive monitoring is carried out depending on the application requirements, with one or two encoder systems. The following encoder signals are supported:

- 1 Encoder system: TTL, SIN/COS, SSI (Gray code / binary code)
- 2 Encoder systems: TTL, SIN/COS, SSI (Gray code / binary code), Resolver, HTL

Safe drive monitoring of the compact controller PSC1-C-10

The safe drive monitoring with the compact controller PSC1-C-10 is realised by an integrated solution. Depending on the order option, the compact controller can safely monitor 1 or 2 axes with one encoder system.

Safe drive monitoring of the compact controller PSC1-C-100

A safe drive monitoring is realised with the compact controller PSC1-C-100 via extension modules. In this case, each axis can be safely monitored by one or two encoders. The drive monitoring modules are available for one or two encoders.

19. PROGRAMMABLE MODULAR SAFETY CONTROLLER TECHNICAL SPECIFICATION

	Safe inputs	Safe programmable inputs / outputs	Safe semi-conductor outputs	Safe relay outputs	Signalling outputs	Pulse outputs (clock outputs)	Number of expansion modules, maximum	Safe drive monitoring, number of axes	Universal field bus communication	SDHC Memory card	SD-Bus Gateway	Safe cross and remote I/O communication	Type designation	
PSC1 - C - 10	Compact safety controllers													
	14		4	2	2	2	2						PSC1-C-10	
	14		4	2	2	2	2		X	X	X	X	PSC1-C-10-FB1	
	14		4	2	2	2	2		X	X	X	X	PSC1-C-10-FB1-ECFS	
	14		4	2	2	2	2		X	X	X	X	PSC1-C-10-FB1-PNPS	
	14		4	2	2	2	2		X	X	X	X	PSC1-C-10-FB2	
	14		4	2	2	2	2		X	X	X	X	PSC1-C-10-FB2-PBPS	
	14		4	2	2	2	2			X			PSC1-C-10-MC	
	14		4	2	2	2	2	1					PSC1-C-10-SDM1	
	14		4	2	2	2	2	1	X	X	X	X	PSC1-C-10-SDM1-FB1	
	14		4	2	2	2	2	1	X	X	X	X	PSC1-C-10-SDM1-FB1-ECFS	
	14		4	2	2	2	2	1	X	X	X	X	PSC1-C-10-SDM1-FB1-PNPS	
	14		4	2	2	2	2	1	X	X	X	X	PSC1-C-10-SDM1-FB2	
	14		4	2	2	2	2	1	X	X	X	X	PSC1-C-10-SDM1-FB2-PBPS	
	14		4	2	2	2	2	1		X			PSC1-C-10-SDM1-MC	
	14		4	2	2	2	2	2					PSC1-C-10-SDM2	
	14		4	2	2	2	2	2	X	X	X	X	PSC1-C-10-SDM2-FB1	
	14		4	2	2	2	2	2	X	X	X	X	PSC1-C-10-SDM2-FB1-ECFS	
	14		4	2	2	2	2	2	X	X	X	X	PSC1-C-10-SDM2-FB1-PNPS	
	14		4	2	2	2	2	2	X	X	X	X	PSC1-C-10-SDM2-FB2	
	14		4	2	2	2	2	2	X	X	X	X	PSC1-C-10-SDM2-FB2-PBPS	
	14		4	2	2	2	2	2		X			PSC1-C-10-SDM2-MC	
	Expansion modules													
	12	10			2	2								PSC1-E-31-12DI-10DIO
	12	6		4	2	2								PSC1-E-33-12DI-6DIO-4RO
	Remote I/O module													
	14		4	2	2	2							X	PSC1-E-37-14DI-4DO-2RO-RIO



	Safe inputs	Safe programmable inputs / outputs	Safe semi-conductor outputs	Safe relay outputs	Signalling outputs	Pulse outputs (clock outputs)	Number of expansion modules, maximum	Safe drive monitoring, number of axes	Universal field bus communication	SDHC Memory Card	SD-Bus Gateway	Safe cross and remote I/O communication	Type designation	
PSC1 - C - 100	Compact safety controllers													
	14	20	4	2	6	2	8						PSC1-C-100	
	14	20	4	2	6	2	8		X	X	X	X	PSC1-C-100-FB1	
	14	20	4	2	6	2	8		X	X	X	X	PSC1-C-100-FB1-ECFS	
	14	20	4	2	6	2	8		X	X	X	X	PSC1-C-100-FB1-PNPS	
	14	20	4	2	6	2	8		X	X	X	X	PSC1-C-100-FB2	
	14	20	4	2	6	2	8		X	X	X	X	PSC1-C-100-FB2-PBPS	
	14	20	4	2	6	2	8			X			PSC1-C-100-MC	
	Expansion modules													
	12	10			2	2								PSC1-E-131-12DI-10DIO
	12	6		4	2	2								PSC1-E-133-12DI-6DIO-4RO
	Remote I/O module													
	14		4	2	2	2						X		PSC1-E-37-14DI-4DO-2RO-RIO
	Safe drive monitoring modules													
	12								1					PSC1-E-21-SDM1
	12								1					PSC1-E-22-SDM1-2
12								2					PSC1-E-23-SDM2	
12								2					PSC1-E-24-SDM2-2	

20. AS-INTERFACE SAFETY AT WORK OVERVIEW

DESCRIPTION

Fast mounting, smooth installation

The AS-Interface enables fast mounting and installation of the components in the safety circuit. The safety switchgear devices are connected to each other and also to the AS-i master and the safety monitor via the yellow AS-i two-wire unshielded line. The power supply also comes from the AS-i unshielded 2-wire line. For AS-i slaves with higher power requirements, the black profile cable with 24 VDC auxiliary voltage is available. It is possible to connect not only operational but also fail-safe AS-i slaves to an AS-i master in mixed configuration. The safety functions are smoothly configured in the AS-i safety monitor through the ASIMON software.

Flexible use

Even after installation it is possible to change or enhance an AS-i safety system at any time. This applies to both safety switchgear add-ons and switchgear configuration (e.g. safety links, STOP category, filter times etc.).

A tried-and-tested "multilingual" system

With over 10 million safety switchgears in the field, AS-i Safety is the most successful safety bus in the world. In addition to the smooth wiring and configuration, the fact that AS-Interface can communicate with all conventional and commonly used bus systems, has considerably contributed to this success. For the user of the AS-i Safety System, this means that his system speaks many languages – for instance: PROFIBUS, PROFINET, EtherNet/IP and ModbusTCP. For AS-i safety there are also solutions for the field buses DeviceNet, CC-Link, CANopen and Sercos III. In this way, a universal application through different communication standards is enabled.

An economic solution – also for smaller machines

When does the installation of an AS-i Safety System generate return on investment? When purely considering the costs, cost advantages are already generated – depending on the application – as of six safety switchgear with 6 m connecting cable each – compared to the parallel wiring.

In addition to that, there are advantages, which cannot be directly included in the cost savings. These advantages include the smooth extension possibilities, the increased flexibility for making changes to the safety circuit afterwards and the clearly enhanced diagnostic possibilities. Also the comfortable configuration through the safety monitor is an advantage, which is already featured by the smallest AS-i Safety System.





SYSTEM STRUCTURE

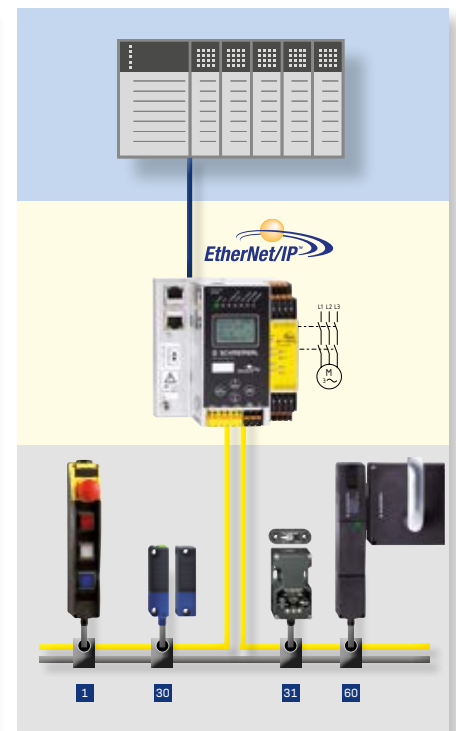
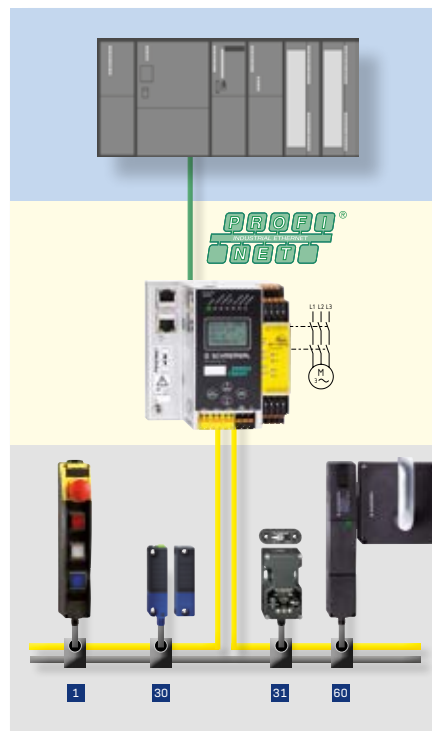

USER ADVANTAGES

- Individually scalable safety solutions for different machine sizes
- Smooth, fail-safe installation and interface connection of the safety switchgear through AS-Interface
- Comfortable configuration of the safety solution through the "ASIMON" Drag & Drop software
- Complete diagnostics of the entire safety circuit and all connected safety switchgear by the control system
- High operational safety through individually configurable safety-monitoring modules with multiple filter functions, e.g. for bouncing safety guards
- The safety functions can be easily changed or extended at a later date
- Cost-advantageous parallel wiring, approximately six switchgears each with a 6m connecting cable



20. AS-INTERFACE SAFETY AT WORK

SAFETY SWITCHES AND SENSORS (PREFERRED TYPES)

Range		Coding	Supply	Termination	Latching force	Actuation direction
AZ 16 AS		Standard coding	AS-i power	Connector M12, 4-pole	5 N	From head From top From below
					30 N	
RSS 36 AS		Standard coding	AS-i power	Connector M12, 4-pole	---	From side
		Individual coding			18 N	

					18 N	
BNS 260 AS		Standard coding	AS-i power	Cable with connector M12, 4-pole	---	From side
BNS 36 AS		Standard coding	AS-i power	Cable with connector M12, 4-pole	---	From side
BNS 16 AS		Standard coding	AS-i power	Connector M12, 4-pole	---	Front side
						Cover-side

EMERGENCY STOP COMMAND DEVICES (PREFERRED TYPES)

Range		Design	Supply	Termination	Fitting Pos. 1	Pos. 2
NAS 311 AS		Emergency-Stop button	AS-i power	Connector M12, 4-pole	NH pushbutton	---
BDF 200 AS		Control panel with Emergency-Stop button	AS-i power	Connector M12, 4-pole	NH pushbutton	LMRD
						LTGN
						SWS20
					NHK pushbutton with protective collar	LMRD
						LTWH
SWS20						



A wide variety of other types can be found at products.schmersal.com and in our AS-i brochure.

Sao/Sar	Housing material	Actuator	Type designation	Material number
---	Plastic	AZ 15/16-B1 AZ 15/16-B2 AZ 15/16-B6	AZ 16 ST1-AS	101161809
			AZ 16 ST1-AS R	101167262
10/20 mm	Plastic	RST 36-1 RST 36-1-R RST16-1 RST-U-2	RSS 36-ST-AS	103001531
			RSS 36-ST-AS-R	103001534
			RSS 36-I2-ST-AS	103001538
			RSS 36-I2-ST-AS-R	103001539
5/15 mm	Plastic	BPS 260-1 BPS 260-2	BNS 260 STG-AS-R	101186155
			BNS 260 STG-AS-L	101186156
7/17 mm	Plastic	BPS 36-1 BPS 36-2	BNS 36 STG-AS-R	101194956
			BNS 36 STG-AS-L	101194955
8/18 mm	Plastic	BPS 16	BNS 16 ST1-AS-V	101177221
			BNS 16 ST1-AS-D	101177222

Pos. 3	Pos. 4	Indicator lamp	Type designation	Material number
---	---	---	NAS 311 ST1-AS	101173041
LTWH	LTBU	---	BDF200-ST1-AS-NH-LMRD-LTWH-LTBU	101214617
LTYE	LTWH	Red / Green	BDF200-ST1-AS-NH-LTGN-LTYE-LTWH-G24	103005880
LTWH	LTYE	---	BDF200-ST1-AS-NH-SWS20-LTWH-LTYE	103006605
LTWH	LTBU	---	BDF200-ST1-AS-NHK-LMRD-LTWH-LTBU	101215387
LTBU	LTWH	---	BDF200-ST1-AS-NHK-LTWH-LTBU-LTWH	101215280
LTWH	LTBU	Red / Green	BDF200-ST1-AS-NHK-SWS20-LTWH-LTBU-G24	101214618

20. AS-INTERFACE SAFETY AT WORK

SAFETY SOLENOID INTERLOCKS (PREFERRED TYPES)

Range	Coding	Supply Interlocking solenoid	Termination	Latching force	Special features
AZM 161 AS 	Standard coding	AS-i power	Connector M12, 4-pole	30 N	Manual release
		AUX Power			Manual release
		Manual release			
		Manual release			
		Emergency exit			
AZM 170 AS 	Standard coding	AUX Power	Connector M12, 4-pole	30 N	Manual release
					Manual release
AZM 201 AS 	Standard coding	AUX Power	Connector M12, 4-pole	30 N	Manual release
	Individual coding				Manual release
					Manual release
					Manual release
					Manual release
MZM 100 AS 	Standard coding	AUX Power	Connector M12, 4-pole	30 ... 100 N	---
					Permanent magnet

					Permanent magnet
AZM 300 AS 	Standard coding	AS-i power	Connector M12, 4-pole	25 N / 50 N	Manual release
	Individual coding				Manual release
					Emergency exit
	Manual release				
	Manual release				
	Emergency exit				
	Standard coding	AUX Power			Manual release
	Individual coding				Manual release
Emergency exit					
Manual release					
Emergency exit					

SAFETY LIGHT GRIDS

Range	Type to EN 61496	Safety version	Supply	Termination	Special features
SLG 440 AS 	Type 4	Light grids SLG	AUX Power	Connector M12, 4-pole	Integrated AS-i Safety module

A wide variety of other types can be found at products.schmersal.com and in our AS-i brochure.

Guard locking monitored	Actuator monitored	Power to lock	Power to unlock	Type designation	Material number
	■	■		AZM 161 B-ST1-AS-RA	101209097
■			■	AZM 161 Z-ST1-AS-R	101209107
	■	■		AZM 161 B-ST1-AS-RAP	101209090
■			■	AZM 161 Z-ST1-AS-RP	101209109
■			■	AZM 161 Z-ST1-AS-RPT	101216398
	■	■		AZM 170 B ST-AS RAP	101210414
■	■		■	AZM 170 BZ ST-AS RP-2197	101211516
	■	■		AZM 201B-ST-T-AS-A-P	103025301
■			■	AZM 201Z-ST-T-AS-P	103025866
■	■		■	AZM 201BZ-ST-T-AS-P	103025873
	■	■		AZM 201B-I2-ST-T-AS-A-P	103025857
■			■	AZM 201Z-I2-ST-T-AS-P	103025868
■	■		■	AZM 201BZ-I2-ST-T-AS-P	103025874
	■	■		MZM 100 B ST-AS REAP	101198705
	■	■		MZM 100 B ST-AS REMAP	101209551
■		■		MZM 100 ST-AS REAP	101198704
■		■		MZM 100 ST-AS REMAP	101209553
	■	■		AZM300B-ST-AS-A	103005902
■			■	AZM300Z-ST-AS	103005916
■			■	AZM300Z-ST-AS-T	103009476
	■	■		AZM300B-I2-ST-AS-A	103005906
■			■	AZM300Z-I2-ST-AS	103005920
■			■	AZM300Z-I2-ST-AS-T	103011892
	■	■		AZM300B-ST-AS-A-P	103005899
■			■	AZM300Z-ST-AS-P	103005913
■			■	AZM300Z-ST-AS-P-T	103009481
	■	■		AZM300B-I2-ST-AS-A-P	103005904
■			■	AZM300Z-I2-ST-AS-P	103005918
■			■	AZM300Z-I2-ST-AS-P-T	103009483

Resolution	Protection heights	Range	Type designation	Material number
2 beams	500 mm	0.3 ... 12 m	SLG440AS-ER-0500-02	103007551
3 beams	800 mm		SLG440AS-ER-0800-03	103007554
4 beams	900 mm		SLG440AS-ER-0900-04	103007557

20. AS-INTERFACE SAFETY AT WORK

SAFETY LIGHT CURTAINS

Range	Type to EN 61496	Safety version	Supply	Termination	Special features	
SLC 440 AS		Type 4	Light curtain SLC	AUX Power	Connector M12, 4-pole	Integrated AS-i Safety module

Resolution	Protection heights	Range	Type designation	Material number
14 mm	170 mm	0.3...7 m	SLC440AS-ER-0170-14	103007432
14 mm	250 mm	0.3...7 m	SLC440AS-ER-0250-14	103007438
14 mm	330 mm	0.3...7 m	SLC440AS-ER-0330-14	103007444
14 mm	410 mm	0.3...7 m	SLC440AS-ER-0410-14	103007450
14 mm	490 mm	0.3...7 m	SLC440AS-ER-0490-14	103007456
14 mm	570 mm	0.3...7 m	SLC440AS-ER-0570-14	103007462
14 mm	650 mm	0.3...7 m	SLC440AS-ER-0650-14	103007468
14 mm	730 mm	0.3...7 m	SLC440AS-ER-0730-14	103007474
14 mm	810 mm	0.3...7 m	SLC440AS-ER-0810-14	103007480
14 mm	890 mm	0.3...7 m	SLC440AS-ER-0890-14	103007486
14 mm	970 mm	0.3...7 m	SLC440AS-ER-0970-14	103007492
14 mm	1050 mm	0.3...7 m	SLC440AS-ER-1050-14	103007498
14 mm	1130 mm	0.3...7 m	SLC440AS-ER-1130-14	103007504
14 mm	1210 mm	0.3...7 m	SLC440AS-ER-1210-14	103007514
14 mm	1290 mm	0.3...7 m	SLC440AS-ER-1290-14	103007520
14 mm	1370 mm	0.3...7 m	SLC440AS-ER-1370-14	103007526
14 mm	1450 mm	0.3...7 m	SLC440AS-ER-1450-14	103007532
30 mm	170 mm	0.3...10 m	SLC440AS-ER-0170-30	103007435
30 mm	250 mm	0.3...10 m	SLC440AS-ER-0250-30	103007441
30 mm	330 mm	0.3...10 m	SLC440AS-ER-0330-30	103007447
30 mm	410 mm	0.3...10 m	SLC440AS-ER-0410-30	103007453
30 mm	490 mm	0.3...10 m	SLC440AS-ER-0490-30	103007459
30 mm	570 mm	0.3...10 m	SLC440AS-ER-0570-30	103007465
30 mm	650 mm	0.3...10 m	SLC440AS-ER-0650-30	103007471
30 mm	730 mm	0.3...10 m	SLC440AS-ER-0730-30	103007477
30 mm	810 mm	0.3...10 m	SLC440AS-ER-0810-30	103007483
30 mm	890 mm	0.3...10 m	SLC440AS-ER-0890-30	103007489
30 mm	970 mm	0.3...10 m	SLC440AS-ER-0970-30	103007495
30 mm	1050 mm	0.3...10 m	SLC440AS-ER-1050-30	103007501
30 mm	1130 mm	0.3...10 m	SLC440AS-ER-1130-30	103007511
30 mm	1210 mm	0.3...10 m	SLC440AS-ER-1210-30	103007517
30 mm	1290 mm	0.3...10 m	SLC440AS-ER-1290-30	103007523
30 mm	1370 mm	0.3...10 m	SLC440AS-ER-1370-30	103007529
30 mm	1450 mm	0.3...10 m	SLC440AS-ER-1450-30	103007535
30 mm	1530 mm	0.3...10 m	SLC440AS-ER-1530-30	103007538
30 mm	1610 mm	0.3...10 m	SLC440AS-ER-1610-30	103007541
30 mm	1690 mm	0.3...10 m	SLC440AS-ER-1690-30	103007544
30 mm	1770 mm	0.3...10 m	SLC440AS-ER-1770-30	103007547

20. AS-INTERFACE SAFETY AT WORK

COMPACT SAFETY INPUT MODULE ASIM-C



■ ASIM-C-M12-4P-...



■ ASIM-C-M12-8P-...

Key Features

Compact safe input module

- Integrated in passive distributor
- For 2 floating NC contacts
- Convenient LED displays
- Pre-wired M12 connector cables, length 0.5 m and 2.0 m

Compact safe input module

- Integrated in passive distributor
- For 2 floating NC contacts
- 50 mA output integrated for LED
- Convenient LED displays
- Pre-wired M12 connector cables, length 0.5 m and 2.0 m

Product version

Type designation / Material number

ASIM-C-M12-4P-0,5M /
103004694
ASIM-C-M12-4P-2M /
103004695

ASIM-C-M12-8P-0,5M /
103004696
ASIM-C-M12-8P-2M /
103004693

Device supply off:

AS-i

AS-i

Technical features

Length of the equipment connection cable	0.5 m and 2.0 m	0.5 m and 2.0 m
Electrical characteristics		
AS-i supply voltage	26.5 V ... 31.6 V	26.5 V ... 31.6 V
AS-i power consumption	≤ 100 mA	≤ 100 mA
AS-i specification	V 3.0	V 3.0
AS-i profile	S-7.B.F.0	S-7.B.F.0
Mechanical data		
Dimensions (W x H x D)	28 x 41 x 22 mm	28 x 41 x 22 mm
Termination	Cable connector M12, 4 pole	Cable connector M12, 8 pole
Ambient conditions		
Ambient temperature	-20 °C ... +60 °C	-20 °C ... +60 °C
Degree of protection	IP67	IP67

Safety classification

Standards	EN ISO 13849-1, IEC 61508	EN ISO 13849-1, IEC 61508
PL/SIL	e/3	e/3
Control category	4	4
PFH	-	-
Certificates	AS-i, TÜV, cULus	AS-i, TÜV, cULus

20. AS-INTERFACE SAFETY AT WORK

ACTIVE SAFETY DISTRIBUTORS



■ BWU3565



■ BWU3635

Key Features

Safe active AS-i distributor

- Connections for profile cable AS-i/AUX
- With 2 safe inputs for OSSDs and one non-safe output
- Convenient LED displays
- Pre-fitted 8-pin M12 connecting cable, 1.0 m in length

Can be used e.g. for equipment types:

- AZM 400

Only non-safe unlocking function!

Safe active AS-i distributor

- Connections for profile cable AS-i/AUX
- With 2 safe inputs for OSSDs and one non-safe output
- Convenient LED displays
- Pre-fitted 8-pin M12 connecting cable, 1.0 m in length

Can be used e.g. for equipment types:

- Series CSS: CSS 180, CSS 30S
- Series RSS: RSS 16
- Series AZM: AZM 201

Product version

Type designation / Material number	BWU3565 / 103016677	BWU3635 / 103016678
Device supply off:	AUX	AUX

Technical features

Length of the equipment connection cable	1.0 m	1.0 m
Electrical characteristics		
AS-i supply voltage	21.6 V ... 31.6 V	21.6 V ... 31.6 V
AS-i power consumption	≤ 60 mA	≤ 60 mA
AUX supply voltage	24 VDC -15 % / +20 %	24 VDC -15 % / +20 %
AUX power consumption	max. 750 mA	max. 750 mA
AS-i specification	V 2.1	V 2.1
AS-i profile	S-7.B.F.1	S-7.B.F.1
Mechanical data		
Dimensions (W x H x D)	60 x 45 x 19 mm	60 x 45 x 19 mm
Termination	Cable connector M12, 8 pole	Cable connector M12, 8 pole
Ambient conditions		
Ambient temperature	-20 °C ... +60 °C	-20 °C ... +60 °C
Degree of protection	IP67	IP67

Safety classification

Standards	EN ISO 13849-1, IEC 61508	EN ISO 13849-1, IEC 61508
PL/SIL	e/3	e/3
Control category	4	4
Certificates	AS-i, cULus	AS-i, cULus

20. AS-INTERFACE SAFETY AT WORK

PASSIVE BUS DISTRIBUTORS AND M12 CONNECTING CABLES

Passive bus distributors



Type: ASSB-2P-1M12-V1 / mat. no.: 103001619

- Flat-cable distributor AS-Interface
- M12 connector, 2-poles
- Degree of protection IP67
- Dimensions 28 mm x 41 mm x 35 mm



Type: ASSB-4P-1M12-V1 / mat. no.: 103001616

- Flat-cable distributor AS-Interface and auxiliary voltage
- M12 connector, 4-poles
- Degree of protection IP67
- Dimensions 28 mm x 41 mm x 35 mm



Type: ASSB-4P-2M12-V1 / mat. no.: 103001617

- Flat-cable distributor AS-Interface and auxiliary voltage
- 2 M12 connectors, 4-poles
- Degree of protection IP67
- Dimensions 28 mm x 41 mm x 35 mm



Type: ASSB-2P-FKB-V1 / mat. no.: 103001620

- Flat-cable connector for 2 flat cables
- 2-pole bridge
- Degree of protection IP67
- Dimensions 28 mm x 41 mm x 22 mm



Type: ASSB-4P-SW-V1 / mat. no.: 103001618

- Flat-cable distributor AS-Interface and auxiliary voltage
- 4 terminals for single wires
- Degree of protection IP67
- Dimensions 28 mm x 41 mm x 35 mm

M12 connecting cables



Type: V-SK4P-M12-...

- M12 connector male – M12 connector female
- PUR cable, PVC-, silicone- and halogen-free
- UL/CSA homologations
- Degree of protection IP67, IP69
- 5 available lengths:
0.5 m, 1.0 m, 1.5 m, 2.0 m, 3.0 m

UP-TO-DATE WITHOUT FAIL THE SCHMERSAL WEBSHOP

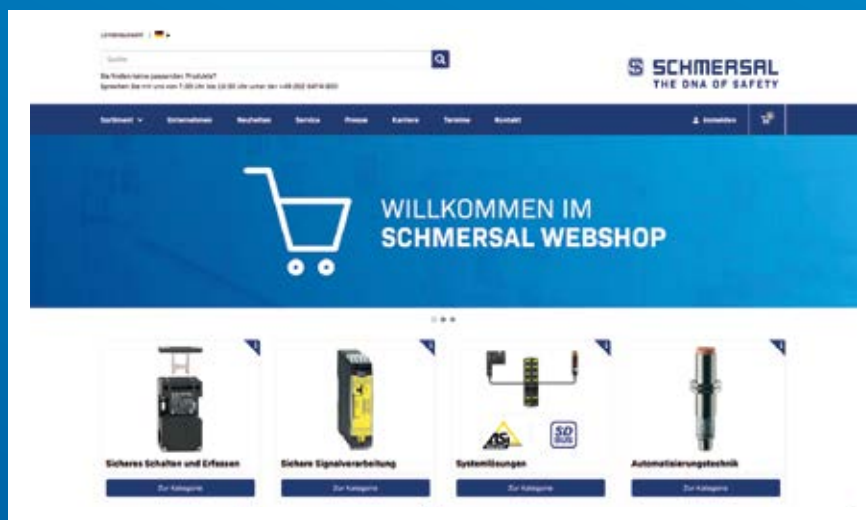

FOR DETAILED INFORMATION, CHECK OUT
[PRODUCTS.SCHMERSAL.COM](https://products.schmersal.com)

21. SD INTERFACE OVERVIEW

DESCRIPTION

Schmersal SD Interface

The "Series Diagnostic" interface is used for transferring non-safe data where electronic safety switchgear is connected in series.

Safety sensors and interlocks that feature the SD interface can transfer extensive diagnostic data from the individual devices with series-wiring via the SD gateway and a field bus to a control system. Interlocks with series-wiring can also be locked or unlocked individually via the SD interface. There are additional control functions on some interlocks from Schmersal, such as the latching force adjustment on the MZM 100-SD.



Mixed installation of sensors and interlocks to form a safety function can be realised easily in the field with the SD interface. The diagnosis data and the actuating data are transferred in the SD interface in series via one wire from the SD gateway to the first SD slave, and from there to the next SD slave and so on. Addressing of the SD slaves takes place automatically. An SD gateway can communicate with up to 31 SD slaves. These 31 SD slaves can also be divided into several different safety functions.

Example SD data of solenoid interlock MZM 100-SD





Bit no.	Request byte	Response byte	Diagnosis message: Error warning	Diagnosis message: Error
Bit 0:	Magnet in, error reset	Safety output activated	Error output Y1	Error output Y1
Bit 1:	Latching force bit	Actuator detected	Error output Y2	Error output Y2
Bit 2:	Latching force bit	Solenoid interlock locked	Cross-wire short	Cross-wire short
Bit 3:	Latching force bit	-	Magnet temperature too high	Magnet temperature too high
Bit 4:	-	Input condition X1 and X2	Locking blocked or F < 500 N	Incorrect or defective actuator
Bit 5:	-	-	Internal device error	Internal device error
Bit 6:	-	Error warning	Communication error between the field bus gateway and the safety switching device	Violent separation of actuator and solenoid interlock (only in connection with "Solenoid interlock monitored")
Bit 7:	Error reset	Error (enabling path switched off)	Operating voltage too low	Operating voltage too low



SD-INTERFACE GATEWAYS

	Description	Type	Material number
	SD-Gateway PROFIBUS	SD-I-DP-V02	101192805
	SD-Gateway PROFINET	SD-I-U-PN	101209434
	SD-Gateway Ethernet/IP	SD-I-U-EIP	101210747
	SD-Gateway EtherCAT	SD-I-U-EC	103008132
	SD-Gateway DeviceNET	SD-I-U-DN	101209432
	SD-Gateway CC-Link	SD-I-U-CCL	101209435
	SD-Gateway CANopen	SD-I-U-CAN	101209433
	SD-Gateway ModbusTCP	SD-I-U-MT	101218029

SD-INTERFACE ACCESSORIES

	Description	Type	Material number
	<ul style="list-style-type: none"> Passive distribution module for SD interface 4 device connections for electronic safety switchgear (see page 273) 	PDM-SD-4CC-SD	103012161
	<ul style="list-style-type: none"> Passive fieldbox IP67 for SD interface systems 4 device connections for electronic safety switchgear (see page 273) 	PFB-SD-4M12-SD	103013574
	<ul style="list-style-type: none"> Y-adaptor 2 couplings, 8-pole; 1 connector, 8-pole M12 screw locking 	CSS-Y-8P	101209416
	<ul style="list-style-type: none"> Terminating plug for Y-adaptor 1 connector, 8-pole M12 screw locking 	CSS-Y-A-8P	101209414

22. PASSIVE DISTRIBUTION MODULES AND FIELDBOXES OVERVIEW

AREA OF APPLICATION

The installation systems for fail-safe series-wiring are installation aids for fast, simple and thereby low cost wiring of safety switchgear in series.

The solutions come either as passive distribution modules or field boxes or as versions for parallel IO wiring or wiring with the Schmersal SD Interface. All versions are designed for mixed series connection of different types of electronic safety switchgear, such as sensors and interlocks.

Further information can be found in the brochure "Installation systems for fail-safe series-wiring".

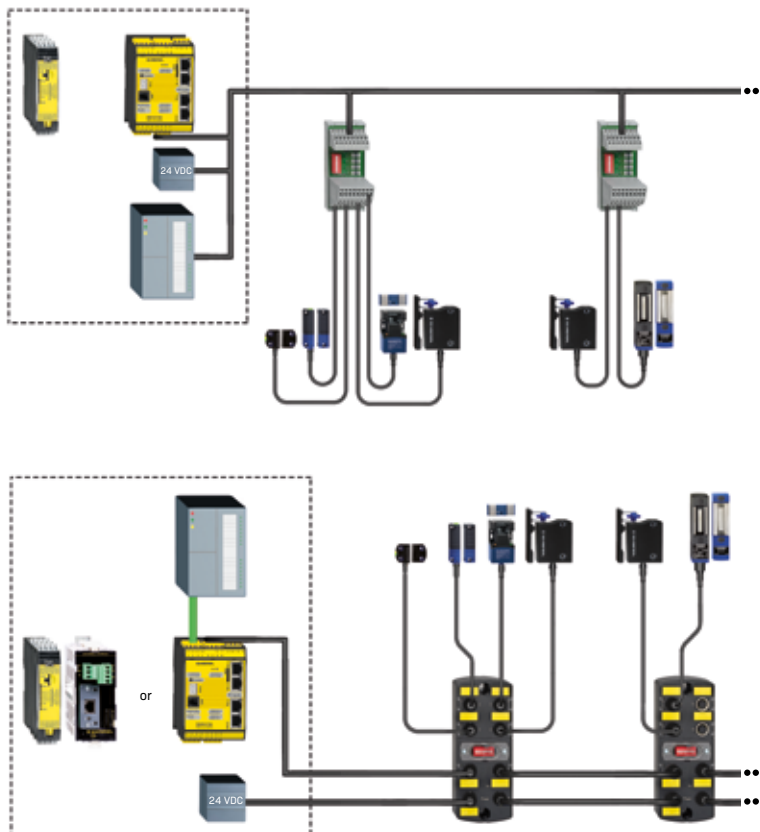



PASSIVE DISTRIBUTION MODULES PDM







- Installation in a switching cabinet or in terminal boxes
- Mixed series connection possible of 1–4 electronic safety sensors or solenoid interlocks
- Several modules can be switched in series for more comprehensive safety functions
- Individual safeguarding of safety switchgear for every device connection with auto-reset fuses
- Can be configured easily via DIP switches
- Individual diagnosis and actuation of connected safety switchgear
- Wiring via spring-type terminals suitable for 0.25 ... 1.5 mm² / 10 A
- Compact design with a width of only 45 mm on the profile rail
- Versions available for parallel IO wiring and for SD interface

PASSIVE FIELDBOXES PFB



- Heavy duty IP67 version for installation in the field
- Mixed series connection possible of 1–4 electronic safety sensors or solenoid interlocks
- Several field boxes can be switched in series for more comprehensive safety functions
- Individual safeguarding of safety switchgear for every device connection with auto-reset fuses
- Can be configured easily via DIP switches
- Individual diagnosis and actuation of connected safety switchgear
- Voltage supply via new M12 power plug with cross section of 1.5 mm² / 10 A
- Compact fieldbox with dimensions 63 mm x 156 mm
- Versions available for parallel IO wiring and for SD interface

22. PASSIVE DISTRIBUTION MODULES AND FIELDBOXES

		Description	Type	Material number
Passive distribution modules PDM		Passive distribution module for IO parallel wiring of safety switchgear	PDM-IOP-4CC-IOP	103012160
		Passive distribution module for SD interface systems of safety switchgear	PDM-SD-4CC-SD	103012161
Passive field boxes PFB		Passive fieldbox for IO parallel wiring of safety switchgear	PFB-IOP-4M12-IOP	103013573
		Passive fieldbox for SD interface systems of safety switchgear	PFB-SD-4M12-SD	103013574

	Description	Length [m]	Type	Material number
M12 power cables, 4-pin, straight, T-coded	Pre-wired cable, female connector	5.0	A-K4P-M12P-S-G-5M-BK-2-X-T-4	103013430
		10.0	A-K4P-M12P-S-G-10M-BK-2-X-T-4	103013431
	Connecting cable, male / female connectors	3.0	V-SK4P-M12P-S-G-3M-BK-2-X-T-4	103013432
		5.0	V-SK4P-M12P-S-G-5M-BK-2-X-T-4	103013433
		7.5	V-SK4P-M12P-S-G-7,5M-BK-2-X-T-4	103013434
M12 SD wires, IN and OUT signals, 4-pin, straight, A-coded	Pre-wired cable, male connector	5.0	A-S4P-M12-S-G-5M-BK-2-X-A-4-69	103013421
		10.0	A-S4P-M12-S-G-10M-BK-2-X-A-4-69	103013422
	Connecting cable, male / male connectors	3.0	V-SS4P-M12-S-G-3M-BK-2-X-A-4-69	103013423
		5.0	V-SS4P-M12-S-G-5M-BK-2-X-A-4-69	103013424
		7.5	V-SS4P-M12-S-G-7,5M-BK-2-X-A-4-69	103013425
M12 IO wires, 8-pin, straight, A-coded	Pre-wired cable, male connector	5.0	A-S8P-M12-S-G-5M-BK-2-X-A-4-69	103013426
		10.0	A-S8P-M12-S-G-10M-BK-2-X-A-4-69	103013427
M12 device connection cables, 8-pin, straight, A-coded	Connecting cable, male / female connectors	0.5	V-SK8P-M12-S-G-0,5M-BK-2-X-A-4-69	101217786
		1.0	V-SK8P-M12-S-G-1M-BK-2-X-A-4-69	101217787
		1.5	V-SK8P-M12-S-G-1,5M-BK-2-X-A-4-69	101217788
		2.5	V-SK8P-M12-S-G-2,5M-BK-2-X-A-4-69	101217789
		3.5	V-SK8P-M12-S-G-3,5M-BK-2-X-A-4-69	103013428
		5.0	V-SK8P-M12-S-G-5M-BK-2-X-A-4-69	101217790
		7.5	V-SK8P-M12-S-G-7,5M-BK-2-X-A-4-69	103013429
		10	V-SK8P-M12-S-G-10M-BK-2-X-A-4-69	103013125
		15	V-SK8P-M12-S-G-15M-BK-2-X-A-4-69	103038984
		20	V-SK8P-M12-S-G-20M-BK-2-X-A-4-69	103038566
		30	V-SK8P-M12-S-G-30M-BK-2-X-A-4-69	103038567

	Description	Amount	Type	Material number
Further accessories	Adhesive seal for PFB / SFB	4	ACC-PFB-SFB-SLLAB-4PCS	103013919
	M12 protective caps for PFB / SFB	10	ACC-PFB-SFB-M12-PCAP-10PCS	103013920
	Labels for PFB / SFB	20	ACC-PFB-SFB-LAB-SN-20PCS-V2	103035090

23. SAFETY FIELD BOXES SFB OVERVIEW

DESCRIPTION

SFB-PN-V2, the interface solution for PROFINET/PROFIsafe systems

The secure SFB-PN-V2 field box for PROFINET/PROFIsafe systems is suitable for simple plug and play installation of up to eight switchgear devices.

The universal device interface with 8-pole M12 connector allows connection of a wide range of different switchgear devices: electromechanical and electronic solenoid interlocks, switches, sensors, light curtains and control panels.

Flexible use

The safety signals from the connected safety switchgear are forwarded to a safety controller via the secure PROFINET/PROFIsafe field bus interface for evaluation. Parallel transfer of safety signals allows free connection of the safety switchgear devices in the F control.

The diagnostic signals of the connected switchgear devices can also be evaluated. An additional digital input is integrated on every M12 device port for this purpose. In addition, the device connections on the field box can also be configured for connection for a range of devices to allow for maximum flexibility in the conception of safety solutions. All device connections can also be equipped with a self-resetting fuse for wiring protection. After eliminating the overload at one of the device ports, the fuse resets itself after a short cool-down phase.

A summary of user benefits

The safety field box is a simple and cost-effective installation solution for complex machinery and systems that allows flexible safety solutions to be individually configured.

UNIVERSAL M12 DEVICE PORTS, 8-POLES





USER ADVANTAGES

- Safety fieldbox for installation of up to 8 safety switchgear devices
- PROFINET/PROFIsafe field bus interface
- Integrated dual-port switch, IRT-capable
- M12 power connector with 10 A current capacity for installation of a wide range of safety systems
- Universal 8-pin M12 device sockets suitable for electromechanical and electronic safety switches, sensors and solenoid interlocks as well as light curtains and control panels.
 - Electronic safety sensors with p-type semiconductor outputs (OSSD)
 - Electronic solenoid interlocks with p-type semiconductor outputs (OSSD) and 1-channel or 2-channel actuation of the interlock function
 - Active opto-electronic protective device (AOPD), such as safety light curtains and light grids
 - Control panels with electronic EMERGENCY-STOP function and non-safe command and signalling devices
 - Safety switches and reed sensors with 2 NC contacts
 - Solenoid interlocks with 2 NC contacts and 1-channel solenoid control up to 0.8 A
- Optimum process transparency through transfer of all diagnostic signals from connected devices to the control system. A digital input is available on each device socket.
- Line protection with integrated automatic resettable fuse for all device connections.
- Robust, industry-suitable design
 - Fibre-glass reinforced thermoplastic enclosure
 - Protection class IP66 / IP67
 - Operating temperature range -20 °C to +55 °C
 - cULus approval
- Wide range of accessories available

ORDERING DETAILS

Type	Material number
SFB-PN-IRT-8M12-IOP-V2	103040357

23. SAFETY FIELD BOXES SFB

AN OVERVIEW OF THE TECHNICAL DATA



■ SFB-PN-IRT-8M12-IOP-V2

Technical features

General technical data	
Standards	EN 61131-1, EN 61131-2, EN ISO 13849-1, IEC 61508, EN 62061
Mechanical data	
Electrical connection version:	Connector socket/connector
- Device ports X0 - X7	M12 / 8-pole, A-coded
- Power I/O	M12-POWER / 4-pole, T-coded
- PROFINET P1/P2	M12 / 4-pole, D-coded
Materials:	
- Enclosure	Polyamide / PA 6 GF
- Inspection window	Polyamide / PACM12
- Encapsulation	Polyurethane / 2K PU
- Labelling plates	Polyamide / PA
Ambient conditions	
Ambient temperature	-25 °C ... +55 °C
Degree of protection	IP66 / IP67 to IEC 60529
Resistance to shock	30 g / 11 ms
Resistance to vibration	5 ... 10 Hz, amplitude 3.5 mm 10 ... 150 Hz, amplitude 0.35 mm / 5 g
Electrical data	
Supply voltage U_s	24 VDC -15% / +10 %
Operating current I_o	10 A
Current capacity, device supply socket X0 - X7	0.8 A
Current capacity, digital output socket X0 - X7	0.8 A
Field bus interface	
Field bus protocol:	PROFINET / PROFI-safe
- PROFINET	V2.3, Conformance Class C, MRP
- PROFI-safe	V2.4
Transmission rate	100 Mbit/s Full Duplex
Integrated switch	Dual Port, 100 Mbit/s, IRT capable
Service interface	WEB-Interface HTTP
Safety values	
2-channel safety inputs	PL e, Category 4, SIL 3
1-channel safety inputs	PL c, Category 1, SIL 1
Safety outputs 1 cable	PL d, Category 3, SIL 2
Safety outputs 2 cables	PL e, Category 4, SIL 3

23. SAFETY FIELD BOXES SFB

WIRING EXAMPLE AND ACCESSORIES

Parameter	Value	Wiring example - Solenoid interlock
Safety inputs	2-channel	
Cross-wire monitoring	OFF	
Safety outputs	1 cable (PL d)	
Monitoring time	2 s	
Stable time	0.1 s	
Safety values Inputs X1 & X2: - up to Cat. 4 / PL e / SIL 3 Output DO: - up to Cat. 3 / PL d / SIL 2		

POWER SUPPLY CABLES

Length	Material number	Use
M12 Power pre-wired cable, (open-end female connector)		
5.0	103013430	SFB Power connection, cable from power adapter to SFB
10.0	103013431	
20.0	103038975	
30.0	103038976	
M12 Power connecting cables (male connector - female connector)		
0.3	103038977	SFB Power connection, Power cable between two SFBs
0.5	103025138	
1.5	103025136	
3.0	103013432	
5.0	103013433	
7.5	103013434	
10.0	103038978	
15.0	103038979	

FIELD BUS CABLES

Length	Material number	Use
RJ-45 - M12 ETHERNET cables (RJ45 - M12)		
5.0	103013435	SFB Ethernet connection, Ethernet cable from the switch or control to the SFB
7.5	103013436	
10.0	103013437	
20.0	103038980	
M12 - M12 ETHERNET cables (M12 - M12)		
0.3	103038981	SFB Ethernet connection, Ethernet cable between two SFBs
1.5	103038982	
3.0	103013438	
5.0	103013439	
7.5	103013440	
10.0	103038983	

DEVICE CONNECTION CABLES

Length	Material number	Use
M12-8-pole, device connection cables (M12 - M12)		
0.25	103014812	Most KAS safety switchgear devices have an 8-pin M12 connector. e.g. the following devices: - RSS 36, RSS 16 - CSS 180, CSS 30S - AZM 300, AZM 201, MZM 100 - AZM 400 - AZM 161-FB, AZM 170-FB - BDF 200-FB, BDF 100 NH(K) - PSS 2x6 x12-ST, PSS 3x6 x12-ST
0.5	101217786	
1.0	101217787	
1.5	101217788	
2.5	101217789	
3.5	103013428	
5.0	101217790	
7.5	103013429	
10.0	103013125	
15.0	103038984	
20.0	103038566	
30.0	103038567	

Length in metres



tec.nicum

tec.nicum – Developed services relating to the machine safety and industrial safety

In the Schmersal Group, tec.nicum is the department for services relating to machine and industrial safety. The experts of tec.nicum give advice to both the machine manufacturers and the machine operators.

The functional safety is a complex matter that has to be taken into account when developing, upgrading and converting existing machinery as well as when integrating machinery into overall plants.

Consulting of machine manufacturers

The experts at tec.nicum advise and accompany machine manufacturers throughout the entire conformity certification process, not only in accordance with the European Machinery Directive, but also with other national regulations in the target markets worldwide.

Consulting of machine operators

On the side of the machine operators, tec.nicum offers machine- and plant-specific risk assessment services in Europe, which, according to the Framework Directive 89/391/EEC, serves to “improve the safety and health of workers at work”.

Thanks to a worldwide consulting network, the services can be accessed easily and conveniently on site. The Functional Safety Engineers certified by TÜV Rheinland have both in-depth knowledge of the regionally or nationally applicable directives, laws and regulations as well as technical know-how and many years of experience in the implementation of projects.

The experts at tec.nicum aim to offer customers competent, product and manufacturer-neutral advice and support them in analysing and designing their machines and workplaces to comply with the standards.

For all of its consultancy and solution strategies, tec.nicum sets great store by objectivity.



academy



- Seminars and training
- Inhouse training
- Customer-specific workshops
- Demonstration events
- Symposia

consulting



- Safety analyses of machines and production lines
- Conformity assessment and verification
- Risk assessments
- Hazard assessments
- Technical documentation

engineering



- Technical project planning
- Validation of safety functions
- Measurements and tests
- Modernisation of machines
- Safety controller programming

integration



- Conversion / Retrofitting
- Installation of protective devices and fences
- Integration of safety functions
- Maintenance and service

tec.nicum

The range at tec.nicum covers four columns: learning in the **academy** section, consultancy services in the **consulting** section, designing safety solutions in the **engineering** section and practical implementation in the **integration** section.

The head office of the tec.nicum organisation, which operates all over the world, is in Wuppertal, Germany.

Contact:

tec.nicum

K.A. Schmersal GmbH & Co. KG
Möddinghofe 30
42279 Wuppertal
Phone: +49 202 6474-932
Telefax: +49 202 6474-100
E-Mail: info-de@tecnicum.com
www.tecnicum.com



APPENDIX

PRE-WIRED AND CONNECTING CABLES

PRE-WIRED CABLES M8, 3 POLE

Description	Length	Type	Part number:
Pre-wired cable with female plug	2.0 m	A-K3P-M8-R-G-2M-BK-2-X-X-4-69	103011093
Pre-wired cable with female plug	2.0 m	A-K3P-M8-S-G-2M-BK-2-X-X-4-69	103011091
Pre-wired cable with female plug	2.5 m	A-K3P-M8-R-G-2,5M-GY-1-X-X-4	103011095
Pre-wired cable with female plug	5.0 m	A-K3P-M8-S-G-5M-BK-2-X-X-4-69	103011092
Pre-wired cable with female plug	2.0 m	A-K3P-M8-S-W-2M-GY-1-2LP-X-4	103011096

PRE-WIRED CABLES M8, 4 POLE

Description	Length	Type	Part number:
Pre-wired cable with female plug	2.0 m	A-K4P-M8-R-G-2M-GY-1-X-X-4	103011341
Pre-wired cable with female plug	5.0 m	A-K4P-M8-R-G-5M-GY-1-X-X-4	103011342
Pre-wired cable with female plug	10.0 m	A-K4P-M8-R-G-10M-GY-1-X-X-4	103011343
Pre-wired cable with female plug	2.0 m	A-K4P-M8-R-W-2M-GY-1-X-X-4	103011344
Pre-wired cable with female plug	5.0 m	A-K4P-M8-R-W-5M-GY-1-X-X-4	103011345
Pre-wired cable with female plug	10.0 m	A-K4P-M8-R-W-10M-GY-1-X-X-4	103011346
Pre-wired cable with female plug	2.0 m	A-K4P-M8-S-G-2M-BK-2-X-X-4-69	103011340
Pre-wired cable with female plug	5.0 m	A-K4P-M8-S-G-5M-BK-2-X-X-2	103007356
Pre-wired cable with female plug	10.0 m	A-K4P-M8-S-G-10M-BK-2-X-X-2	103007357
Pre-wired cable with female plug	10.0 m	A-K4P-M8-S-G-10M-GY-1-X-X-4	103011347
Pre-wired cable with female plug	2.0 m	A-K4P-M8-S-W-2M-GY-1-X-X-4	103011348
Pre-wired cable with female plug	5.0 m	A-K4P-M8-S-W-5M-GY-1-X-X-4	103011349
Pre-wired cable with female plug	10.0 m	A-K4P-M8-S-W-10M-GY-1-X-X-4	103011350

PRE-WIRED CABLES M8, 8 POLE

Description	Length	Type	Part number:
Pre-wired cable with female plug	2.0 m	A-K8P-M8-S-G-2M-BK-2-X-A-4	103003638
Pre-wired cable with female plug	5.0 m	A-K8P-M8-S-G-5M-BK-2-X-A-4	103003639
Pre-wired cable with female plug	10.0 m	A-K8P-M8-S-G-10M-BK-2-X-A-4	103003640
Pre-wired cable with female plug	15.0 m	A-K8P-M8-S-G-15M-BK-2-X-A-4	103009042
Pre-wired cable with female plug	2.0 m	A-K8P-M8-S-W-2M-BK-2-X-A-4	103003641
Pre-wired cable with female plug	5.0 m	A-K8P-M8-S-W-5M-BK-2-X-A-4	103003642
Pre-wired cable with female plug	10.0 m	A-K8P-M8-S-W-10M-BK-2-X-A-4	103003643

APPENDIX

PRE-WIRED AND CONNECTING CABLES

PRE-WIRED CABLES M8, 8 POLE

Description	Length	Type	Part number:
Pre-wired cable with female plug	2.0 m	A-K3P-M12-S-G-2M-GY-1-X-A-4	103010722
Pre-wired cable with female plug	2.0 m	A-K3P-M12-S-W-2M-GY-1-2LP-A-4	103010718
Pre-wired cable with female plug	2.0 m	A-K3P-M12-S-W-2M-GY-1-X-A-4	103010724
Pre-wired cable with female plug	3.0 m	A-K3P-M12-S-W-3M-BK-2-2LP-A-4-69	103010720
Pre-wired cable with female plug	5.0 m	A-K3P-M12-S-W-5M-BK-2-2LP-A-4-69	103010721
Pre-wired cable with female plug	5.0 m	A-K3P-M12-S-W-5M-GY-1-X-A-4	103010723
Pre-wired cable with female plug	10.0 m	A-K3P-M12-S-W-10M-GY-1-2LP-A-4	103010719

PRE-WIRED CABLES M12, 4 POLE

Description	Length	Type	Part number:
Pre-wired cable with female plug	2.0 m	A-K4P-M12-S-G-2M-BK-2-X-A-4	103010891
Pre-wired cable with female plug	5.0 m	A-K4P-M12-S-G-5M-BK-1-X-A-4	103006760
Pre-wired cable with female plug	5.0 m	A-K4P-M12-S-G-5M-BK-2-X-A-4	103010892
Pre-wired cable with female plug	10.0 m	A-K4P-M12-S-G-10M-BK-2-X-A-4	103010893
Pre-wired cable with female plug	5.0 m	A-K4P-M12-S-G-5M-BK-2-X-A-4-075	103010894
Pre-wired cable with female plug	5.0 m	A-K4P-M12-S-G-5M-GY-2-X-B-4-69-075	103010895
Pre-wired cable with female plug	15.0 m	A-K4P-M12-S-G-15M-GY-2-X-A-4-69-075	103012537
Pre-wired cable with female plug	15.0 m	A-K4P-M12-S-G-15M-GY-2-X-B-4-69-075	103012539

PRE-WIRED CABLES M12, 5 POLE

Description	Length	Type	Part number:
Pre-wired cable with female plug	5.0 m	A-K5P-M12-S-G-5M-BK-2-X-A-4-69	103010816
Pre-wired cable with female plug	10.0 m	A-K5P-M12-S-G-10M-BK-2-X-A-4-69	103010818
Pre-wired cable with female plug	15.0 m	A-K5P-M12-S-G-15M-BK-2-X-A-4-69	103010820

APPENDIX

PRE-WIRED AND CONNECTING CABLES

PRE-WIRED CABLES M12, 8 POLE

Description	Length	Type	Part number:
Pre-wired cable with female plug	5.0 m	A-K8P-M12-S-G-5M-BK-1-X-A-4-69-VA	101210560
Pre-wired cable with female plug	10.0 m	A-K8P-M12-S-G-10M-BK-1-X-A-4-69-VA	103001389
Pre-wired cable with female plug	15.0 m	A-K8P-M12-S-G-15M-BK-1-X-A-4-69-VA	103014823
Pre-wired cable with female plug	2.5 m	A-K8P-M12-S-G-2.5M-BK-2-X-A-4-69	103011415
Pre-wired cable with female plug	5.0 m	A-K8P-M12-S-G-5M-BK-2-X-A-4-69	103007358
Pre-wired cable with female plug	10.0 m	A-K8P-M12-S-G-10M-BK-2-X-A-4-69	103007359
Pre-wired cable with female plug	15.0 m	A-K8P-M12-S-G-15M-BK-2-X-A-4-69	103011414
Pre-wired cable with female plug	5.0 m	A-K8P-M12-S-G-5M-GY-1-X-A-4	103011412
Pre-wired cable with female plug	10.0 m	A-K8P-M12-S-G-10M-GY-1-X-A-4	103011413
Pre-wired cable with female plug	15.0 m	A-K8P-M12-S-G-15M-GY-1-X-A-4	103011787
Pre-wired cable with female plug	5.0 m	A-K8P-M12-S-W-5M-BK-1-X-A-4-69-VA	101210561
Pre-wired cable with female plug	15.0 m	A-K8P-M12-S-W-15M-BK-1-X-A-4-69-VA	103015608
Pre-wired cable with female plug	5.0 m	A-K8P-M12-S-W-5M-GY-1-X-A-4	103011416
Pre-wired cable with female plug	10.0 m	A-K8P-M12-S-W-10M-GY-1-X-A-4	103015608

PRE-WIRED CABLES M23, 8+1 POLE

Description	Length	Type	Part number:
Pre-wired cable with female plug	5.0 m	A-K8+1P-M23-S-G-5M-BK-1-X-X-4	101209959
Pre-wired cable with female plug	10.0 m	A-K8+1P-M23-S-G-10M-BK-1-X-X-4	101209958
Pre-wired cable with female plug	15.0 m	A-K8+1P-M23-S-G-15M-BK-1-X-X-4	103001384

PRE-WIRED CABLES M23, 12 POLE

Description	Length	Type	Part number:
Pre-wired cable with female plug	5.0 m	A-K12P-M23-S-G-5M-GY-1-X-X-1-2568	101208520
Pre-wired cable with female plug	10.0 m	A-K12P-M23-S-G-10M-GY-1-X-X-1-2568	103007354
Pre-wired cable with female plug	10.0 m	A-K12P-M23-S-G-10M-GY-1-X-X-2	101210707

CONNECTING CABLES M12, 4 POLE

Description	Length	Type	Part number:
Connecting cable, male / female connectors	0.5 m	V-SK4P-M12-S-G-0.5M-BK-2-X-A-4-69	103002576
Connecting cable, male / female connectors	1.0 m	V-SK4P-M12-S-G-1.0M-BK-2-X-A-4-69	103002577
Connecting cable, male / female connectors	1.5 m	V-SK4P-M12-S-G-1.5M-BK-2-X-A-4-69	103002571
Connecting cable, male / female connectors	2.0 m	V-SK4P-M12-S-G-2.0M-BK-2-X-A-4-69	103002573
Connecting cable, male / female connectors	3.0 m	V-SK4P-M12-S-G-3.0M-BK-2-X-A-4-69	103002575

APPENDIX

PRE-WIRED AND CONNECTING CABLES

CONNECTING CABLES M12, 8 POLE

Description	Length	Type	Part number:
Connecting cable, male / female connectors	0.25 m	V-SK8P-M12-S-G-0,25M-BK-2-X-A-4-69	103014812
Connecting cable, male / female connectors	0.5 m	V-SK8P-M12-S-G-0,5M-BK-2-X-A-4-69	101217786
Connecting cable, male / female connectors	1.0 m	V-SK8P-M12-S-G-1M-BK-2-X-A-4-69	101217787
Connecting cable, male / female connectors	1.5 m	V-SK8P-M12-S-G-1,5M-BK-2-X-A-4-69	101217788
Connecting cable, male / female connectors	2.5 m	V-SK8P-M12-S-G-2,5M-BK-2-X-A-4-69	101217789
Connecting cable, male / female connectors	3.5 m	V-SK8P-M12-S-G-3,5M-BK-2-X-A-4-69	103013428
Connecting cable, male / female connectors	5.0 m	V-SK8P-M12-S-G-5M-BK-2-X-A-4-69	101217790
Connecting cable, male / female connectors	7.5 m	V-SK8P-M12-S-G-7,5M-BK-2-X-A-4-69	103013429
Connecting cable, male / female connectors	10.0 m	V-SK8P-M12-S-G-10M-BK-2-X-A-4-69	103013125
Connecting cable, male / female connectors	15.0 m	V-SK8P-M12-S-G-15M-BK-2-X-A-4-69	103038984
Connecting cable, male / female connectors	20.0 m	V-SK8P-M12-S-G-20M-BK-2-X-A-4-69	103038566
Connecting cable, male / female connectors	30.0 m	V-SK8P-M12-S-G-30M-BK-2-X-A-4-69	103038567
Connecting cable, male / female connectors, VA	0.5 m	V-SK8P-M12-S-G-0,5M-BK-2-X-A-2-69-VA	103008416
Connecting cable, male / female connectors, VA	1.5 m	V-SK8P-M12-S-G-1,5M-BK-2-X-A-2-69-VA	103008418
Connecting cable, male / female connectors, VA	2.0 m	V-SK8P-M12-S-G-2,0M-BK-2-X-A-2-69-VA	103008419
Connecting cable, male / female connectors, VA	2.5 m	V-SK8P-M12-S-G-2,5M-BK-2-X-A-2-69-VA	103008420
Connecting cable, male / female connectors, VA	3.0 m	V-SK8P-M12-S-G-3,0M-BK-2-X-A-2-69-VA	103008980
Connecting cable, male / female connectors, VA	5.0 m	V-SK8P-M12-S-G-5,0M-BK-2-X-A-2-69-VA	103008981

CONNECTOR WITHOUT CABLE M8 / 4 POLE

Description	Length	Type	Part number:
Connector, female plug	---	S-K4P-M8-S-G-X-X-X-X-1	101210015

CONNECTOR WITHOUT CABLE M12 / 4 POLE

Description	Length	Type	Part number:
Connector, female plug	---	S-K4P-M12-S-G-X-X-X-X-A	101209950
Connector, female plug	---	S-K4P-M12-S-G-X-X-X-X-B-1	101209976
Connector, female plug	---	S-K4P-M12-S-W-X-X-X-2LP-A-1	101209977

CONNECTOR WITHOUT CABLE M18 / 4 POLE

Description	Length	Type	Part number:
Connector, female plug	---	S-K4P-M18-S-G-X-X-X-X-A-1	101209979
Connector, female plug	---	S-K4P-M18-S-W-X-X-X-X-A-1	101209984

APPENDIX

PRE-WIRED AND CONNECTING CABLES

CONNECTOR WITHOUT CABLE M23 / 8+1 POLE

Description	Length	Type	Part number:
Connector, female plug, screw terminals	---	S-K8+1P-M23-S-G-X-X-X-X-4	101209970
Connector, female connector, crimping technology	---	S-K8+1P-M23-S-G-X-X-X-X-4 (CRIMP)	101209994

CONNECTOR WITHOUT CABLE DIN43650

Description	Length	Type	Part number:
Connector, female plug	---	S-K2P+PE-DIN43650-S-W-X-X-X-X-4	101209972
Connector, female plug	---	S-K3P+PE-DIN43650-S-W-X-X-X-X-3	101209974

CONNECTING CABLE M8 TO M12

Description	Length	Type	Part number:
4-pin connecting cable M8 to M12	1.0 m	V-SK4P-M12/M8-S-G-1M-BK-2-X-A-4	103003648
4-pin connecting cable M8 to M12	2.0 m	V-SK4P-M12/M8-S-G-2M-BK-2-X-A-4	103003649
4-pin connecting cable M8 to M12	3.0 m	V-SK4P-M12/M8-S-G-3M-BK-2-X-A-4	103003651
8-pin connecting cable M8 to M12	0.3 m	V-SK8P-M12/M8-S-G-0,3M-BK-2-X-A-4	103009832
8-pin connecting cable M8 to M12	0.5 m	V-SK8P-M12/M8-S-G-0.5M-BK-2-X-A-4	103009917
8-pin connecting cable M8 to M12	1.0 m	V-SK8P-M12/M8-S-G-1.0M-BK-2-X-A-4	103014813
8-pin connecting cable M8 to M12	2.0 m	V-SK8P-M12/M8-S-G-2M-BK-2-X-A-4	103003645
8-pin connecting cable M8 to M12	3.0 m	V-SK8P-M12/M8-S-G-3M-BK-2-X-A-4	103014814
8-pin connecting cable M8 to M12	5.0 m	V-SK8P-M12/M8-S-G-5M-BK-2-X-A-4	103014815

ADAPTER CABLE FOR KAS DEVICES TO 5-PIN M12

Description	Length	Type	Part number:
Adapter cable 8-pin M12 to 5-pin M12	0.5 m	VFB-SK5P/8P-M12-S-G-0,5M-BK-2-X-A-4	103013303

APPENDIX

PRE-WIRED AND CONNECTING CABLES

PFB: M12 POWER CABLES, 4-PIN, STRAIGHT, T-CODED

Description	Length	Type	Part number:
Pre-wired cable, female connector	5.0 m	A-K4P-M12P-S-G-5M-BK-2-X-T-4	103013430
Pre-wired cable, female connector	10.0 m	A-K4P-M12P-S-G-10M-BK-2-X-T-4	103013431
Pre-wired cable, female connector	20.0 m	A-K4P-M12P-S-G-20M-BK-2-X-T-4	103038975
Pre-wired cable, female connector	30.0 m	A-K4P-M12P-S-G-30M-BK-2-X-T-4	103038976
Connecting cable, male / female connectors	0.3 m	V-SK4P-M12P-S-G-0.3M-BK-2-X-T-4	103038977
Connecting cable, male / female connectors	0.5 m	V-SK4P-M12P-S-G-0.5M-BK-2-X-T-4	103025138
Connecting cable, male / female connectors	1.5 m	V-SK4P-M12P-S-G-1.5M-BK-2-X-T-4	103025136
Connecting cable, male / female connectors	3.0 m	V-SK4P-M12P-S-G-3M-BK-2-X-T-4	103013432
Connecting cable, male / female connectors	5.0 m	V-SK4P-M12P-S-G-5M-BK-2-X-T-4	103013433
Connecting cable, male / female connectors	7.5 m	V-SK4P-M12P-S-G-7,5M-BK-2-X-T-4	103013434
Connecting cable, male / female connectors	10.0 m	V-SK4P-M12P-S-G-10M-BK-2-X-T-4	103038978
Connecting cable, male / female connectors	15.0 m	V-SK4P-M12P-S-G-15M-BK-2-X-T-4	103038979

PFB: M12 SD CABLES, IN & OUT SIGNALS, 4-PIN, STRAIGHT, A-CODED

Description	Length	Type	Part number:
Pre-wired cable, male connector	5.0 m	A-S4P-M12-S-G-5M-BK-2-X-A-4-69	103013421
Pre-wired cable, male connector	10.0 m	A-S4P-M12-S-G-10M-BK-2-X-A-4-69	103013422
Pre-wired cable, male connector	30.0 m	A-S4P-M12-S-G-30M-BK-2-X-A-4-69	103038985
Connecting cable, male / male connectors	0.5 m	V-SS4P-M12-S-G-0.5M-BK-2-X-A-4-69	103025139
Connecting cable, male / male connectors	1.5 m	V-SS4P-M12-S-G-1.5M-BK-2-X-A-4-69	103025140
Connecting cable, male / male connectors	3.0 m	V-SS4P-M12-S-G-3M-BK-2-X-A-4-69	103013423
Connecting cable, male / male connectors	5.0 m	V-SS4P-M12-S-G-5M-BK-2-X-A-4-69	103013424
Connecting cable, male / male connectors	7.5 m	V-SS4P-M12-S-G-7,5M-BK-2-X-A-4-69	103013425
Connecting cable, male / male connectors	15.0 m	V-SS4P-M12-S-G-15M-BK-2-X-A-4-69	103038986

PFB: M12 IO CABLES, 8-PIN, STRAIGHT, A-CODED

Description	Length	Type	Part number:
Pre-wired cable, male connector	5.0 m	A-S8P-M12-S-G-5M-BK-2-X-A-4-69	103013426
Pre-wired cable, male connector	10.0 m	A-S8P-M12-S-G-10M-BK-2-X-A-4-69	103013427

PRE-WIRED AND CONNECTING CABLES

ORDERING CODE

(1)-(2)-(3)-(4)-(5)-(6)-(7)-(8)-(9)-(10)-(11)-(12)-(13)-(14)

No.	Option	Description	No.	Option	Description	
(1)	A	Cable Pre-wired cable	(7)	X	Cable colour Without	
	V	Connecting cable		BK	Black	
	S	Connector without cable		GN	Green	
	AIE	Pre-wired cable industrial ethernet		GY	Grey	
	VIE	Connecting cable industrial ethernet		OG	Orange	
	VFB	Connecting cable for fieldboxes				
(2)a		Connector	(8)	X	Material of the cable -	
	K	Female plug		1	PVC	
	KK	Female plug – female plug		2	PUR	
	S	Male connector		3	Rubber	
	SS	Connector – connector		4	Silicone	
(2)b		Number of pins	(9)	X	Miscellaneous Neutral	
	3P	3-pin		1LP	1x LED – PNP	
	4P	4-pin		2LP	2x LED – PNP	
	5P	5-pin		3LP	3x LED – PNP	
	6P	6-pin				
	7P	7-pin	(10)	X	Coding Without	
	8P	8-pin		A	A-coding	
	9P	9-pin		B	B-coding	
	10P	10-pin		D	D-coding	
	11P	11-pin		T	T-coding	
	12P	12-pin				
	23P	23-pin				
	2P+PE	2-pin +PE		(11)	1	Approval without
	3P+PE	3-pin +PE			2	UL
					3	CSA
		4	USA/CAN			
(3)		Termination	(12)	69	Degree of protection IP69	
	M8	M8 / round 8 mm		69K	IP69K	
	M12	M12				
	M18	M18				
	M23	M23				
	M12P	M12 Power				
	RJ45	RJ45				
DIN43650	DIN 43650					
(4)		Interlocking device	(13)	VA	Material of thread/union nut VA	
	R	Latching interlocking				
(5)	S	Screw locking	(14)	075	Special cross section of cores 0.75 mm ²	
	G	Design Straight				
(6)	W	Angled				
	X	Cable length Without				
	0.3M	0.3 m				
	0.5M	0.5 m				
	1M	1 m				
	1.5M	1.5 m				
	2 M	2 m				
	2.5M	2.5 m				
	3M	3 m				
	3.5M	3.5 m				
	5M	5 m				
	7.5M	7.5 m				
	10M	10 m				
	15M	15 m				
	20M	20 m				

Notice

The existing key type is used to translate the product type designation. Not all versions can be supplied.

UP-TO-DATE WITHOUT FAIL ONLINE PRODUCT CATALOGUE

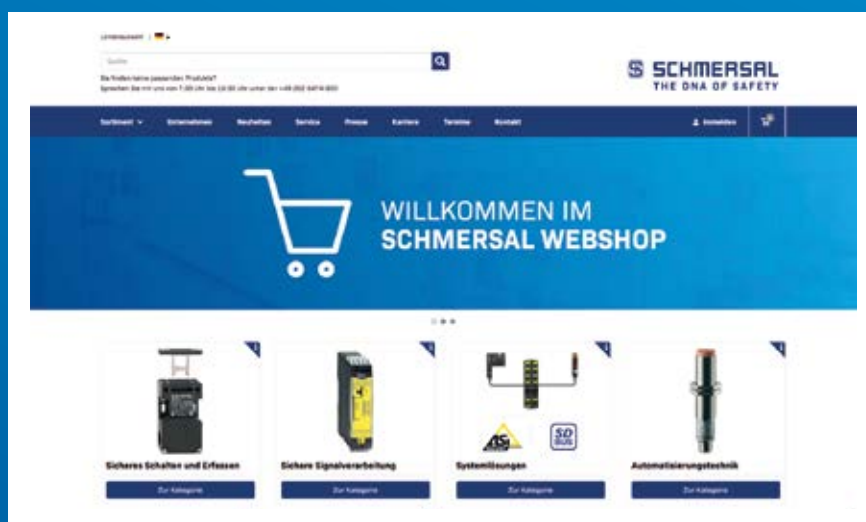

FOR DETAILED INFORMATION, CHECK OUT
[PRODUCTS.SCHMERSAL.COM](https://products.schmersal.com)

APPENDIX

PRODUCT INDEX – ALPHABETICAL

Range	Chapter	Page	Range	Chapter	Page	Range	Chapter	Page
A			CSS 30S	6	131	SE70	13	186
ADRR40	8	152	CSS 34	6	131	SEP09	12	179
AES 1102	17	240	E			SEPG05	12	178
AES 1112	17	240	EDRR40RT	8	146	SEPK02	12	178
AF	8	154	EDRRS40RT	8	146	SFB	23	276
ASIM	20	266	EDRZ40RT	8	146	SHGV	3	68
AZ 15	1	12	EF	8	154	SHGV/ESS21	3	76
AZ 16	1	12	M			SLB240	15	202
AZ 17	1	12	MBGAC	8	156	SLB440	15	202
AZ 201	1	13	MBK	8	156	SLB440-H	15	202
AZ 3350	1	13	MZM 100	2	35	SLC240COM	16	204
AZ 415	1	13	N			SLC420	16	206
AZM40	2	34	NBG	8	156	SLC420 M/S	16	206
AZM150	2	32	NDRR50RT	8	148	SLC440	16	210
AZM 161	2	32	NDRZ50RT	8	148	SLC440COM	16	210
AZM 170	2	33	P			SLC445	16	210
AZM 190	2	33	PDM	22	283	SLG240COM	16	204
AZM 201	2	34	PFB	22	283	SLG420	16	207
AZM 300	2	34	PROTECT PSC1-C-10	19	266	SLG422-P	16	207
AZM 400	2	34	PROTECT PSC1-C-100	19	267	SLG440	16	211
AZM 415	2	33	PROTECT SELECT	18	260	SLG440COM	16	211
B			PS116	4	90	SLG445	16	211
BDF100	9	160	PS215	4	90	SMS 4	14	194
BDF200	9	160	PS216	4	91	SMS 5	14	194
BNS 120	6	124	PS226	4	91	SRB100DR	17	236
BNS 16	6	121	PS315	4	91	SRB202MSL	17	237
BNS 180	6	124	PS316	4	91	SRB301ST-230V	17	236
BNS 250	6	120	R			SRB402EM	17	237
BNS 260	6	120	RDRZ45RT	8	150	SRB-E-201LC	17	228
BNS 30	6	125	RF	8	154	SRB-E-201ST	17	228
BNS 300	6	125	RS655	7	140	SRB-E-204PE	17	231
BNS 303	6	124	RS656	7	140	SRB-E-204ST	17	231
BNS 36	6	121	RSS 16	6	130	SRB-E-212ST	17	229
BNS 40S	6	120	RSS 36	6	130	SRB-E-232ST	17	230
BNS-B20	6	125	S			SRB-E-301MC	17	229
BWU	20	267	SD Gateway	21	281	SRB-E-301ST	17	229
C			SE-100C	13	190	SRB-E-302FWS-TS	17	232
CSS 180	6	131	SE-304C	13	190	SRB-E-302ST	17	229
CSS 30	6	131	SE40	13	186	SRB-E-322ST	17	230
CSS 300	6	131	SE-400C	13	191	SRB-E-402EM	17	231

APPENDIX

PRODUCT INDEX – ALPHABETICAL

Range	Chapter	Page
SRB-E-402FWS-TS	17	232
SRB-E-402ST	17	231
SVE	3	78
SVM	3	72
T		
T.C 235	5	108
T.C 236	5	108
T2FH 232	11	174
TESK	5	112
TESZ	5	112
TFH 232	11	174
TV.S 335	5	110
TV.S 355	5	110
Z		
ZQ 700	7	140
ZQ 900	7	140
ZSD5	10	170
ZSD6	10	170

Addresses

■ **Hauptsitz – Headquarters**
K.A. Schmersal GmbH & Co. KG
Postfach 24 02 63,
42232 Wuppertal
Möddinghofe 30
42279 Wuppertal
Phone: +49 202 6474-0
Fax: +49 202 6474-100
info@schmersal.com
www.schmersal.com

GERMANY

■ **Berlin**
**KSA Komponenten der Steuerungs-
und Automatisierungstechnik GmbH**
Pankstraße 8-10 / Aufg. L
13127 Berlin
Phone: +49 30 474824-00
Fax: +49 30 474824-05
info@ksa-gmbh.de
www.ksa-gmbh.de

■ **Hannover**
ELTOP GmbH
Robert-Bosch-Straße 8
30989 Gehrden
Phone: +49 51 089273-20
Fax: +49 51 089273-21
eltop@eltop.de
www.eltop.de

■ **Köln**
Stollenwerk
Technisches Büro GmbH
Scheuermühlenstraße 40
51147 Köln
Phone: +49 2203 96620-0
Fax: +49 2203 96620-30
info@stollenwerk.de
www.stollenwerk.de

■ **Siegen**
Siegfried Klein
Elektro-Industrie-Vertretungen
In der Steinwiese 46
57074 Siegen
Phone: +49 271 6778
Fax: +49 271 6770
info@sk-elektrotechnik.de
www.sk-elektrotechnik.de

■ **Saarland**
**Herbert Neundorfer Werks-
vertretungen GmbH & Co. KG**
Am Campus 5
66287 Göttelborn
Phone: +49 6825 9545-0
Fax: +49 6825 9545-99
info@herbert-neundoerfer.de
www.herbert-neundoerfer.de

■ **Bayern Süd**
INGAM Ing. Adolf Müller GmbH
Industrievertretungen
Elly-Staegmeyer-Straße 15
80999 München
Phone: +49 89 8126044
Fax: +49 89 8126925
info@ingam.de
www.ingam.de

EUROPE

■ **Austria – Österreich**
AVS-Schmersal Vertriebs Ges.m.b.H.
Biróstraße 17
1232 Wien
Phone: +43 1 61028
Fax: +43 1 61028-130
info@avs-schmersal.at
www.avs-schmersal.at

■ **Belgium – Belgien**
Schmersal Belgium NV/SA
Nieuwlandlaan 73
Industriezone B413
3200 Aarschot
Phone: +32 16 5716-18
Fax: +32 16 5716-20
info@schmersal.be
www.schmersal.be

■ **Bosnia and Herzegovina**
Tipteh d.o.o. Sarajevo
Ulica Ramiza Salčina 246
71000 Sarajevo
Phone: +387 61 923623
nadir.durmic@tipteh.ba
www.tipteh.ba

■ **Bulgaria – Bulgarien**
STRATONS
Han Omurtag 33 str. Office 2
7002 Ruse
Phone: +359 879 060788
Phone: +359 883 474148
office@stratons.bg
www.stratons.bg

■ **Croatia – Kroatien**
Tipteh Zagreb d.o.o.
Ratarska 35
10000 Zagreb
Phone: +385 1 38165-74
Fax: +385 1 38165-77
tipteh@tipteh.hr
www.tipteh.hr

■ **Czech Republic – Tschech. Republik**
MERCOM COMPONENTA s.r.o.
Bechyňská 640
199 00 Praha 9 – Letňany
Phone: +420 267 314640
mercom@mercom.cz
www.mercom.cz
www.schmersal.cz

■ **Denmark – Dänemark**
Schmersal Danmark A/S
Arnold Nielsens Boulevard 72
2650 Hvidovre
Phone: +45 702090-27
Fax: +45 702090-37
info@schmersal.dk
www.schmersal.dk

■ **Estonia – Estland**
Advancetec Oy
Äyritie 12 B
01510 Vantaa
Phone: +3 58 207199430
Fax: +3 58 935052660
advancetec@advancetec.fi
www.schmersal.fi

■ **Finland – Finnland**
Advancetec Oy
Äyritie 12 B
01510 Vantaa
Phone: +3 58 207199430
Fax: +3 58 935052660
advancetec@advancetec.fi
www.schmersal.fi

■ **France – Frankreich**
Schmersal France
BP 18 – 38181 Seyssins Cedex
8, rue Raoul Follereau
38180 Seyssins
Phone: +33 4 76842320
technique@schmersal.com
info-fr@schmersal.com
www.schmersal.fr

■ **Greece – Griechenland**
Kalamarakis Sapounas S.A.
Ionias & Neromilou
PO Box 46566 Athens
13671 Chamomilos Acharnes
Athens
Phone: +30 210 2406000-6
Fax: +30 210 2406007
ksa@ksa.gr
www.ksa.gr

■ **Hungary – Ungarn**
**NTK Ipari-Elektronikai és
Kereskedelmi Kft**
Gesztenyefa u. 4.
9027 Győr
Phone: +36 96 523268
Fax: +36 96 430011
info@ntk-kft.hu
www.ntk-kft.hu

■ **Iceland – Island**
Reykjafell Ltd.
Skipholtí 35
125 Reykjavík
Phone: +354 5 8860-10
Fax: +354 5 8860-88
reykjafell@reykjafell.is

■ **Italy – Italien**
Schmersal Italia s.r.l.
Via Molino Vecchio, 206
25010 Borgosatollo, Brescia
Phone: +39 030 25074-11
Fax: +39 030 25074-31
info@schmersal.it
www.schmersal.it

■ **Latvia – Lettland**
BOPLALIT
Mus galite rasti:
Baltų pr. 145, LT-47125, Kaunas
Phone: +370 37 298989
Phone: +370 37 406718
info@boplalit.lt
www.boplalit.lt

■ **Lithuania – Litauen**
BOPLALIT
Mus galite rasti:
Baltų pr. 145, LT-47125, Kaunas
Phone: +370 37 298989
Phone: +370 37 406718
info@boplalit.lt
www.boplalit.lt

■ **Macedonia – Mazedonien**
Tipteh d.o.o. Skopje
Bul Partizanski odredi br:80, Lok:5
1000 Skopje
Phone: +389 23 174197
info@tipteh.mk
www.tipteh.mk

■ **Netherlands – Niederlande**
Schmersal Nederland B.V.
Lorentzstraat 31
3846 AV Harderwijk
Phone: +31 341 432525
Fax: +31 341 425257
info-nl@schmersal.com
www.schmersal.nl

■ **Norway – Norwegen**
Schmersal Norge
Hoffsveien 92
0377 Oslo
Phone: +47 220600-70
Fax: +47 220600-80
info-no@schmersal.com
www.schmersal.no

■ **Poland – Polen**
Schmersal - Polska Sp.j.
ul. Baletowa 29
02-867 Warszawa
Phone: +48 22 2508800
Fax: +48 22 8168580
info@schmersal.pl
www.schmersal.pl

■ **Portugal – Portugal**
Schmersal Ibérica, S.L.
Apartado 30
2626-909 Póvoa de Sta. Iria
Phone: +351 219 593835
info-pt@schmersal.com
www.schmersal.pt

■ **Romania – Rumänien**
SC SENSODATA SRL
Str. Autogarii, no. 16
550135 Sibiu
Phone: +4 0 770 796640
office@sensodata.ro
www.sensodata.ro

■ **Serbia – Serbien**
Tipteh d.o.o. Serbia
Toplice Milana 14A
11050 Belgrade
Phone: +3 11 2892250
Fax: +3 11 3018326
office@tipteh.rs
www.tipteh.rs

■ **Slovakia – Slowakei**
MERCOM COMPONENTA s.r.o.
Bechyňská 640
199 00 Praha 9 – Letňany
Phone: +420 267 314640
mercom@mercom.cz
www.mercom.cz
www.schmersal.cz

■ **Slovenia – Slowenien**
Tipteh d.o.o.
Ulica Ivana Roba 21
1000 Ljubljana
Phone: +386 1 20051-50
Fax: +386 1 20051-51
info@tipteh.si
www.tipteh.si

■ **Spain – Spanien**
Schmersal Ibérica, S.L.
Rambla P. Catalanes, N° 12
08800 Vilanova i la Geltrú
Phone: +34 902 566457
info-es@schmersal.com
www.schmersal.es

■ **Sweden – Schweden**
Schmersal Nordiska AB
F O Petersons gata 28
421 31 Västra Frölunda
Phone: +46 31 33835-00
Fax: +46 31 33835-39
info-se@schmersal.com
www.schmersal.se

■ **Switzerland – Schweiz**
Schmersal Schweiz AG
Moosmattstraße 3
8905 Arni
Phone: +41 43 31122-33
Fax: +41 43 31122-44
info-ch@schmersal.com
www.schmersal.ch

■ **Turkey – Türkei**
**Schmersal Turkey Otomasyon
Ürünleri ve Hizmetleri Ltd. Şti.**
Ataturk Mah. Atasehir Bulvarı No. 5
Gardenya Plaza 5 Kat: 2 Daire: 2
Atasehir / Istanbul
Phone: +90 534 033 33 96
info-tr@schmersal.com
www.schmersal.com.tr

■ **Ukraine – Ukraine**
VBR Ltd.
41, Demiyivska Str.
03040 Kyiv Ukraine
Phone: +38 044 2590955
Fax: +38 044 2590955
office@vbr.com.ua
www.vbr-electric.com.ua/schmersal

■ **United Kingdom – Großbritannien**
Schmersal Ltd.
Sparrowhawk Close
Enigma Business Park
Malvern Worcestershire WR14 1LL
Phone: +44 1684 571980
Fax: +44 1684 560273
uksupport@schmersal.com
www.schmersal.co.uk

Addresses

WORLDWIDE

- **Argentina – Argentinien**
Condelectric S.A.
info@condelectric.com.ar
www.condelectric.com.ar
Electro Dos Materiales Electricos S.A.
ventas@electro-dos.com.ar
www.electro-dos.com.ar
- **Australia – Australien**
Control Logic Pty. Ltd.
25 Lavarack Avenue, PO Box 1456
Eagle Farm, Queensland
Phone: +61 1800 557705
Fax: +61 1800 237743
sales@control-logic.com.au
www.control-logic.com.au
- **Belarus – Weißrussland**
ZAO Eximelektro
Ribalko Str. 26-110
BY-220033 Minsk, Belarus
Phone: +375 17 37344-11
Fax: +375 17 37344-22
info@exim.by
www.exim.by
- **Bolivia – Bolivien**
International Fil-Parts
3er. Anillo, 1040, Frente al Zoo
Santa Cruz de la Sierra
Phone: +591 3 342-9900
Fax: +591 3 342-3637
presidente@filparts.com.bo
www.filparts.com.bo
- **Brazil – Brasilien**
ACE Schmersal
Eletrônica Industrial Ltda.
Av. Brasil, nº 815
Jardim Esplanada – CEP: 18557-646,
Boituva – SP
Phone: +55 15 3263-9800
Fax: +55 15 3263-9899
export@schmersal.com.br
www.schmersal.com.br
- **Canada – Kanada**
Schmersal Canada, LTD
29 Centennial Road, Unit 1
Orangeville ON L9W 1R1
Phone: +1 519 307-7540
Fax: +1 519 307-7543
Toll Free: +1 877 889-8816
Info-ca@schmersal.com
www.schmersal.ca
- **Chile – Chile**
Vitel S.A.
francisco@vitel.cl
www.vitel.cl
Electric Parts
asepulveda@eparts.cl
www.eparts.cl
Instrutec Ltda.
gcaceres@instrutec.cl
www.instrutec.cl
SOLTEX CHILE S.A.
central@soltex.cl
www.soltex.com.cl
- **PR China – VR China**
Schmersal Industrial
Switchgear (Shanghai) Co. Ltd.
Cao Ying Road 3336
201712 Shanghai / Qingpu
Phone: +86 21 637582-87
Fax: +86 21 637582-97
sales@schmersal.com.cn
www.schmersal.com.cn
- **Colombia – Kolumbien**
Cimpex Ltda.
jjaramillo@cimpex.co
www.cimpex.co
Dempro S.A.S.
info@dempro.co
www.dempro.co
SAMCO Ingeniería S.A.S.
jkemmerer@samcoingenieria.com
www.samcoingenieria.com
Potencia y Tecnología
ventas@potenciaytecnologia.com
www.potenciaytecnologia.com
- **Costa Rica – Costa Rica**
Euro-Automation – Tec, S.A.
eurotec.jhtg@yahoo.com
- **Ecuador – Ecuador**
SENSORTEC S.A
Bonifaz Cumba N-60 y Pasaje Nagola
Quito
Phone: +593 02 604-3230
ventas@sensortecsa.com
www.sensortecsa.com
- **El Salvador – El Salvador**
PRESTEELECTRO
Anabella.Barrios@prestelectro.com
www.prestelectro.com
- **Guatemala – Guatemala**
ACE Schmersal
Eletrônica Industrial Ltda.
Av. Brasil, nº 815
Jardim Esplanada – CEP: 18557-646,
Boituva – SP
Phone: +55 15 3263-9800
Fax: +55 15 3263-9899
export@schmersal.com.br
www.schmersal.com.br
- **India – Indien**
Schmersal India Private Limited
Plot No G 7/1,
Ranjangaon MIDC,
Taluka Shirur,
District Pune 412220, India
Phone: +91 21 38614700
Fax: +91 20 66861114
info-in@schmersal.com
www.schmersal.in
- **Indonesia – Indonesien**
PT Wiguna Sarana Sejahtera
email@ptwiguna.com
www.ptwiguna.com
PT Helix Electrindo
sales@helixelektrindo.com
www.helixelektrindo.com
- **Israel – Israel**
A.U. Shay Ltd.
23 Imber St. Kiriat. Arieh.
P.O. Box 10049
Petach Tikva 49222 Israel
Phone: +9 72 3923-3601
Fax: +9 72 3923-4601
shay@uriel-shay.com
www.uriel-shay.com
- **Japan – Japan**
Schmersal Japan KK
Shin-yokohama Dai 3 Toshō Bldg.
3-9-5 Shin-yokohama, Kohoku-ku,
Yokohama 222-0033 Japan
Phone: +81 45 476-5777
Fax: +81 45 476-5778
info@schmersal.co.jp
www.schmersal.co.jp
- **Korea – Korea**
Mahani Electric Co. Ltd.
20, Gungmal-ro, Gwacheon-si,
Gyeonggi-do 427-060, Korea
Phone: +82 2 2194-3300
Fax: +82 2 2194-3397
yskim@mec.co.kr
www.mec.co.kr
- **Malaysia – Malaysiaen**
Schmersal (Thailand) Co. Ltd.
71, Sukhumvit 52,
Bang Chak Sub District,
Phra Khanong District,
Bangkok – 10260
Phone: +66 2 117 1723
info@schmersal.co.th
www.schmersal.co.th
- **Mexico – Mexiko**
ISEL
ventas@isel.com.mx
www.isel.com.mx
INNOVATIVE AUTOMOTION SOLUTIONS
schmersal@iasmx.com
www.iasautomation.com.mx
SACCSA, S.A. de C.V
ventas.tecnicas@saccca.mx
www.saccca.mx
EACSA, S.A de C.V
ruben_angeles@eacsamexico.mx
www.eacsamexico.mx
SEPIA, S.A de C.V
alazcano@sepia.mx
www.sepia.mx
JADE, S.A. de C.V
daniel.navarro@jadesoluciones.com
REINSEL
Reinsel-ventas@hotmail.com
Electroconstructora del Golfo S.A.
ventas.dj@electro.mx
www.electro.mx
Controles Industriales Mecatronica
ventasyservicio@mecatronica.com.mx
www.mecatronica.com.mx
SEA INDUSTRIAL
operaciones@sea-industrial.com
www.sea-industrial.com
VGR TECHNOLOGIES
alfredo@vgr.com.mx
www.vgr.com.mx
- **New Zealand – Neuseeland**
Hamer Automation
85A Falsgrave Street
Philipstown
Christchurch, New Zealand
Phone: +64 33 662483
Fax: +64 33 791379
sales@hamer.co.nz
www.hamer.co.nz
- **Pakistan – Pakistan**
Schmersal Middle East-FZE
Post Box No. 341365,
FG-07-1, F-Wing, DSOA HQ Building,
Dubai Silicon Oasis, Dubai
Phone: +971 4 3712-814
+971 4 3712-815
Email: SSambandan@schmersal.com
www.schmersal.com
- **Paraguay – Paraguay**
Brasguay S.R.L.
brasguay@brasguay.com.py
www.brasguay.com.py
- **Peru – Peru**
ACE Schmersal
Eletrônica Industrial Ltda.
Av. Brasil, nº 815
Jardim Esplanada – CEP: 18557-646,
Boituva – SP
Phone: +55 15 3263-9800
Fax: +55 15 3263-9899
export@schmersal.com.br
www.schmersal.com.br
- **Singapore – Singapur**
AZAREL International Pte Ltd.
Empire Techno Centre
30 Kaki Bukit Road 3 #01-10
Singapore 417819
Phone: +65 67 422988
Fax: +65 67 422628
sales@azarel.com.sg
www.azarel.com.sg
- **South Africa – Südafrika**
A+A Dynamic Distributors (Pty) Ltd.
20-24 Augusta Road
Regents Park
2197 Booysens
Phone: +27 11 6815900
Fax: +27 11 4351318
awkayser@iafrica.com
- **Taiwan – Taiwan**
Golden Leader Camel Ent. Co., Ltd.
No. 453-7, Pei Tun Rd.
Taichung City 40648, Taiwan
Phone: +886-4-22 41 29 89
Fax: +886-4-22 41 29 23
camel88@ms46.hinet.net
www.leadercamel.com.tw
- **Thailand – Thailand**
Schmersal (Thailand) Co. Ltd.
71, Sukhumvit 52,
Bang Chak Sub District,
Phra Khanong District,
Bangkok – 10260
Phone: +66 2 117 1723
info@schmersal.co.th
www.schmersal.co.th
- **United Arab Emirates – Vereinigte Arabische Emirate**
Schmersal Middle East-FZE
Post Box No. 341365,
FG-07-1, F-Wing, DSOA HQ Building,
Dubai Silicon Oasis, Dubai
Phone: +971 4 3712-814
+971 4 3712-815
Email: SSambandan@schmersal.com
www.schmersal.com
- **Uruguay – Uruguay**
Eneka S.A.
info@eneka.com.uy
www.eneka.com.uy
Gliston S.A.
colmedo@gliston.com.uy
www.gliston.com.uy
- **USA – USA**
Schmersal Inc.
15 Skyline Drive
Hawthorne, NY 10532
Phone: +1 8 88496-5143
Fax: +1 9 14347-1567
infousa@schmersal.com
www.schmersalusa.com
- **Venezuela – Venezuela**
EMI Equipos y Sistemas C.A.
ventas@emi-ve.com
www.emi-ve.com
- **Vietnam – Vietnam**
Automation Systems And
Equipments Co. Ltd.
info@asae.vn
www.asae.vn
New Ocean Automation System Ltd.
customer@new-ocean.com.vn
www.new-ocean.com.vn

THE SCHMERSAL GROUP

PROTECTION FOR MAN AND MACHINE

In the demanding field of machine safety, the owner-managed Schmersal Group is one of the international market leaders. The company, which was founded in 1945, has a workforce of about 2,000 people and seven manufacturing sites on three continents along with its own companies and sales partners in more than 60 countries.

Customers of the Schmersal Group include global players from the area of mechanical engineering and plant manufacturing as well as operators of machinery. They profit from the company's extensive expertise as a provider of systems and solutions for machine safety. Furthermore, Schmersal specialises in various areas including food & beverage, packaging, machine tools, lift switchgear, heavy industry and automotive.

A major contribution to the systems and solutions offered by the Schmersal Group is made by tec.nicum with its comprehensive range of services: Certified Functional Safety Engineers advise machinery manufacturers and machinery operators in all aspects relating to machinery and occupational safety – and do so with product and manufacturer neutrality. Furthermore, they design and realise complex solutions for safety around the world in close collaboration with the clients.



SAFETY PRODUCTS

- Safety switches and sensors, solenoid interlocks
- Safety controllers and safety relay modules, safety bus systems
- Optoelectronic and tactile safety devices
- Automation technology: position switches, proximity switches

SAFETY SYSTEMS

- Complete solutions for safeguarding hazard areas
- Individual parametrisation and programming of safety controllers
- Tailor-made safety technology – be it for individual machines or a complex production line
- Industry-specific safety solutions

SAFETY SERVICES

- tec.nicum academy – Seminars and training
- tec.nicum consulting – Consultancy services
- tec.nicum engineering – Design and technical planning
- tec.nicum integration – Execution and installation



x.000 / L+W / 07.2022 / Teile-Nr. 103009198 / EN / Ausgabe 06